

OptiFuse FR

↗ Быстродействующие предохранители на токи от 40 до 4000 А



Предохранители плавкие серии OptiFuse FR предназначены для защиты полупроводниковых тиристорных электроприводов, выпрямителей для электролиза и других типов преобразовательных устройств, при этом предохранители могут использоваться также и для применения на электроподвижном составе.

Отрасли применения:

- ржд;
- метрополитен;
- металлургия;
- энергетика.

► Структура условного обозначения

OptiFuse FR S33 600V - 1800A - D08

①	Серия	OptiFuse FR
②	Габарит	S30, S31, S32, S33, S44, S70, S71, S72, S73, S84
③	Номинальное напряжение U_n , В	450, 500, 550, 600, 690, 750, 800, 850, 900, 950, 1000, 1100, 1250
④	Номинальный ток I_n , А	40, 50, 63, 80, 100, 125, 200, 250, 280, 315, 350, 400, 450, 500, 550, 630, 700, 800, 900, 1000, 1100, 1250, 1400, 1500, 1600, 1700, 1800, 2000, 2200, 2500, 2700, 3000, 3500, 4000
⑤	Условное обозначение вида присоединения	TF — потайные контактные колпачки; D08, D11 — контактные ножи. D08 — длина предохранителя с учетом длины контактных ножей составляет 104мм D11 — длина предохранителя с учетом длины контактных ножей составляет 134мм

► Преимущества серии

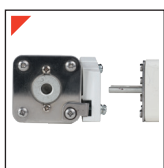

Исполнения контактов: ножевые контакты и потайные контактные колпачки



Дополнительные контакты для сигнализации срабатывания

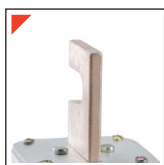



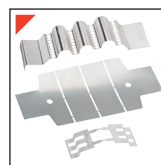

Антикоррозионное покрытие контактов







Для быстрого срабатывания рабочие зоны плавких элементов выполнены из серебра

► Артикулы





OptiFuse FR S30, S31, S32, S33. Тип присоединения TF

Внешний вид	Габарит	Номинальное напряжение AC, Ул, В	Номинальный ток, А	I ² t (А ² · с)		Рассеиваемая мощность, Вт	Наименование	Артикул
				Время плавления, с	Разрыв цепи при Un, А			
	S30	690/700	40	40	270	9	OptiFuse FR-S30-690V-40A-TF	345685
	S30	690/700	50	77	515	11	OptiFuse FR-S30-690V-50A-TF	345686
	S30	690/700	63	115	770	14	OptiFuse FR-S30-690V-63A-TF	345687
	S30	690/700	80	185	1250	18	OptiFuse FR-S30-690V-80A-TF	345688
	S30	690/700	100	360	2450	21	OptiFuse FR-S30-690V-100A-TF	345689
	S30	690/700	125	550	3700	26	OptiFuse FR-S30-690V-125A-TF	345690
	S30	690/700	160	1100	7500	30	OptiFuse FR-S30-690V-160A-TF	345691
	S30	690/700	200	2200	15000	35	OptiFuse FR-S30-690V-200A-TF	345692
	S30	690/700	250	4200	28500	40	OptiFuse FR-S30-690V-250A-TF	345693
	S30	690/700	315	7000	46500	50	OptiFuse FR-S30-690V-315A-TF	345694
	S30	690/700	350	10000	68500	55	OptiFuse FR-S30-690V-350A-TF	345695
	S30	690/700	400	15000	105000	60	OptiFuse FR-S30-690V-400A-TF	345696
	S30	690/700	450	21000	140000	65	OptiFuse FR-S30-690V-450A-TF	345697
	S30	690/700	500	27000	180000	70	OptiFuse FR-S30-690V-500A-TF	345698
		S31	690/700	550	34000	230000	75	OptiFuse FR-S30-690V-550A-TF
S30		690/700	630	48500	325000	80	OptiFuse FR-S30-690V-630A-TF	345700
S31		690/700	160	900	5500	35	OptiFuse FR-S31-690V-160A-TF	345733
S31		690/700	200	1650	11500	45	OptiFuse FR-S31-690V-200A-TF	345734
S31		690/700	250	3100	21000	55	OptiFuse FR-S31-690V-250A-TF	345735
S31		690/700	315	6200	42000	58	OptiFuse FR-S31-690V-315A-TF	345736
S31		690/700	350	8500	59000	60	OptiFuse FR-S31-690V-350A-TF	345737
S31		690/700	400	13500	91500	65	OptiFuse FR-S31-690V-400A-TF	345738
S31		690/700	450	17000	120000	70	OptiFuse FR-S31-690V-450A-TF	345739
S31		690/700	500	25000	170000	72	OptiFuse FR-S31-690V-500A-TF	345740
S31		690/700	550	34000	230000	75	OptiFuse FR-S31-690V-550A-TF	345741
S31		690/700	630	52000	350000	80	OptiFuse FR-S31-690V-630A-TF	345742
S31		690/700	700	69500	465000	85	OptiFuse FR-S31-690V-700A-TF	345743
S31		690/700	800	105000	725000	95	OptiFuse FR-S31-690V-800A-TF	345744
S31		550	900	160000	800000	99	OptiFuse FR-S31-550V-900A-TF	345745
	S32	690/700	315	6000	40000	55	OptiFuse FR-S32-690V-315A-TF	345771
	S32	690/700	350	8000	55000	60	OptiFuse FR-S32-690V-350A-TF	345772
	S32	690/700	400	11000	74000	65	OptiFuse FR-S32-690V-400A-TF	345773
	S32	690/700	450	15500	105000	70	OptiFuse FR-S32-690V-450A-TF	345774
	S32	690/700	500	21500	145000	75	OptiFuse FR-S32-690V-500A-TF	345775
	S32	690/700	550	28000	190000	80	OptiFuse FR-S32-690V-550A-TF	345776
	S32	690/700	630	41000	275000	90	OptiFuse FR-S32-690V-630A-TF	345777
	S32	690/700	700	60500	405000	95	OptiFuse FR-S32-690V-700A-TF	345778
	S32	690/700	800	86000	575000	105	OptiFuse FR-S32-690V-800A-TF	345779
	S32	690/700	900	125000	840000	110	OptiFuse FR-S32-690V-900A-TF	345780
	S32	690/700	1000	180000	1250000	115	OptiFuse FR-S32-690V-1000A-TF	345781
	S32	600	1100	245000	1600000	120	OptiFuse FR-S32-600V-1100A-TF	345782
	S32	550	1250	365000	2400000	130	OptiFuse FR-S32-550V-1250A-TF	345783
	S32	500	1400	400000	3500000	145	OptiFuse FR-S32-500V-1400A-TF	345784
	S32	500	1600	620000	4300000	160	OptiFuse FR-S32-500V-1600A-TF	345785
S32	450	1800	900000	5700000	170	OptiFuse FR-S32-450V-1800A-TF	345786	
	S33	690/700	450	13500	85000	70	OptiFuse FR-S33-690V-450A-TF	345800
	S33	690/700	500	14000	95000	95	OptiFuse FR-S33-690V-500A-TF	345801
	S33	690/700	550	19500	135000	100	OptiFuse FR-S33-690V-550A-TF	345802
	S33	690/700	630	31000	210000	105	OptiFuse FR-S33-690V-630A-TF	345803
	S33	690/700	700	44500	300000	110	OptiFuse FR-S33-690V-700A-TF	345804
	S33	690/700	800	69500	465000	115	OptiFuse FR-S33-690V-800A-TF	345805
	S33	690/700	900	100000	670000	120	OptiFuse FR-S33-690V-900A-TF	345806
	S33	690/700	1000	140000	945000	125	OptiFuse FR-S33-690V-1000A-TF	345807
	S33	690/700	1100	190000	1300000	130	OptiFuse FR-S33-690V-1100A-TF	345808
	S33	690/700	1250	290000	1950000	140	OptiFuse FR-S33-690V-1250A-TF	345809
	S33	690/700	1400	370000	3100000	155	OptiFuse FR-S33-690V-1400A-TF	345810
	S33	600	1500	450000	3600000	158	OptiFuse FR-S33-600V-1500A-TF	345811
	S33	600	1600	580000	3900000	160	OptiFuse FR-S33-600V-1600A-TF	345812
	S33	600	1800	880000	5250000	165	OptiFuse FR-S33-600V-1800A-TF	345813
	S33	550	2000	1150000	6350000	175	OptiFuse FR-S33-550V-2000A-TF	345814
S33	500	2250	1250000	7500000	180	OptiFuse FR-S33-500V-2250A-TF	345815	
S33	450	2500	1870000	9000000	190	OptiFuse FR-S33-450V-2500A-TF	345816	





OptiFuse FR S30, S31, S32, S33. Тип присоединения D08.

Внешний вид	Габарит	Номинальное напряжение AC, Un, В	Номинальный ток, А	I ² t (А ² · с)		Рассеиваемая мощность, Вт	Наименование	Артикул	
				Время плавления, с	Разрыв цепи при Un, А				
	S30	690/700	40	40	270	9	OptiFuse FR-S30-690V-40A-D08	345701	
	S30	690/700	50	77	515	11	OptiFuse FR-S30-690V-50A-D08	345702	
	S30	690/700	63	115	770	14	OptiFuse FR-S30-690V-63A-D08	345703	
	S30	690/700	80	185	1250	18	OptiFuse FR-S30-690V-80A-D08	345704	
	S30	690/700	100	360	2450	21	OptiFuse FR-S30-690V-100A-D08	345705	
	S30	690/700	125	550	3700	26	OptiFuse FR-S30-690V-125A-D08	345706	
	S30	690/700	160	1100	7500	30	OptiFuse FR-S30-690V-160A-D08	345707	
	S30	690/700	200	2200	15000	35	OptiFuse FR-S30-690V-200A-D08	345708	
	S30	690/700	250	4200	28500	40	OptiFuse FR-S30-690V-250A-D08	345709	
	S30	690/700	315	7000	46500	50	OptiFuse FR-S30-690V-315A-D08	345710	
	S30	690/700	350	10000	68500	55	OptiFuse FR-S30-690V-350A-D08	345711	
	S30	690/700	400	15000	105000	60	OptiFuse FR-S30-690V-400A-D08	345712	
	S30	690/700	450	21000	140000	65	OptiFuse FR-S30-690V-450A-D08	345713	
	S30	690/700	500	27000	180000	70	OptiFuse FR-S30-690V-500A-D08	345714	
	S30	690/700	550	34000	230000	75	OptiFuse FR-S30-690V-550A-D08	345715	
	S31	690/700	160	900	5500	35	OptiFuse FR-S31-690V-160A-D08	345746	
	S31	690/700	200	1650	11500	45	OptiFuse FR-S31-690V-200A-D08	345747	
	S31	690/700	250	3100	21000	55	OptiFuse FR-S31-690V-250A-D08	345748	
	S31	690/700	315	6200	42000	58	OptiFuse FR-S31-690V-315A-D08	345749	
	S31	690/700	350	8500	59000	60	OptiFuse FR-S31-690V-350A-D08	345750	
	S31	690/700	400	13500	91500	65	OptiFuse FR-S31-690V-400A-D08	345751	
	S31	690/700	450	17000	120000	70	OptiFuse FR-S31-690V-450A-D08	345752	
	S31	690/700	500	25000	170000	72	OptiFuse FR-S31-690V-500A-D08	345753	
	S31	690/700	550	34000	230000	75	OptiFuse FR-S31-690V-550A-D08	345754	
	S31	690/700	630	52000	350000	80	OptiFuse FR-S31-690V-630A-D08	345755	
	S31	690/700	700	69500	465000	85	OptiFuse FR-S31-690V-700A-D08	345756	
	S31	690/700	800	105000	725000	95	OptiFuse FR-S31-690V-800A-D08	345757	
	S31	550	900	160000	800000	99	OptiFuse FR-S31-550V-900A-D08	345758	
		S32	690/700	315	6000	40000	55	OptiFuse FR-S32-690V-315A-D08	347667
		S32	690/700	350	8000	55000	60	OptiFuse FR-S32-690V-350A-D08	347668
S32		690/700	400	11000	74000	65	OptiFuse FR-S32-690V-400A-D08	347669	
S32		690/700	450	15500	105000	70	OptiFuse FR-S32-690V-450A-D08	347670	
S32		690/700	500	21500	145000	75	OptiFuse FR-S32-690V-500A-D08	347671	
S32		690/700	550	28000	190000	80	OptiFuse FR-S32-690V-550A-D08	347672	
S32		690/700	630	41000	275000	90	OptiFuse FR-S32-690V-630A-D08	347673	
S32		690/700	700	60500	405000	95	OptiFuse FR-S32-690V-700A-D08	347674	
S32		690/700	800	86000	575000	105	OptiFuse FR-S32-690V-800A-D08	347675	
S32		690/700	900	125000	840000	110	OptiFuse FR-S32-690V-900A-D08	347676	
S32		690/700	1000	180000	1250000	115	OptiFuse FR-S32-690V-1000A-D08	347677	
S32		600	1100	245000	1600000	120	OptiFuse FR-S32-600V-1100A-D08	347678	
S32		550	1250	365000	2400000	130	OptiFuse FR-S32-550V-1250A-D08	347679	
		S33	690/700	450	13500	85000	70	OptiFuse FR-S33-690V-450A-D08	345817
		S33	690/700	500	14000	95000	95	OptiFuse FR-S33-690V-500A-D08	345818
	S33	690/700	550	19500	135000	100	OptiFuse FR-S33-690V-550A-D08	345819	
	S33	690/700	630	31000	210000	105	OptiFuse FR-S33-690V-630A-D08	345820	
	S33	690/700	700	44500	300000	110	OptiFuse FR-S33-690V-700A-D08	345821	
	S33	690/700	800	69500	465000	115	OptiFuse FR-S33-690V-800A-D08	345822	
	S33	690/700	900	100000	670000	120	OptiFuse FR-S33-690V-900A-D08	345823	
	S33	690/700	1000	140000	945000	125	OptiFuse FR-S33-690V-1000A-D08	345824	
	S33	690/700	1100	190000	1300000	130	OptiFuse FR-S33-690V-1100A-D08	345825	
	S33	690/700	1250	290000	1950000	140	OptiFuse FR-S33-690V-1250A-D08	345826	
	S33	690/700	1400	370000	3100000	155	OptiFuse FR-S33-690V-1400A-D08	345827	
	S33	600	1500	450000	3500000	158	OptiFuse FR-S33-600V-1500A-D08	345828	
	S33	600	1600	580000	3900000	160	OptiFuse FR-S33-600V-1600A-D08	345829	
	S33	600	1800	880000	5250000	165	OptiFuse FR-S33-600V-1800A-D08	345830	
	S33	550	2000	1150000	6350000	175	OptiFuse FR-S33-550V-2000A-D08	345831	





OptiFuse FR S30, S31, S32, S33. Тип присоединения D11.

Внешний вид	Габарит	Номинальное напряжение AC, Un, В	Номинальный ток, А	I ² t (А ² · с)		Рассеиваемая мощность, Вт	Наименование	Артикул
				Время плавления, с	Разрыв цепи при Un, А			
	S30	690/700	40	40	270	9	OptiFuse FR-S30-690V-40A-D11	345717
	S30	690/700	50	77	515	11	OptiFuse FR-S30-690V-50A-D11	345718
	S30	690/700	63	115	770	14	OptiFuse FR-S30-690V-63A-D11	345719
	S30	690/700	80	185	1250	18	OptiFuse FR-S30-690V-80A-D11	345720
	S30	690/700	100	360	2450	21	OptiFuse FR-S30-690V-100A-D11	345721
	S30	690/700	125	550	3700	26	OptiFuse FR-S30-690V-125A-D11	345722
	S30	690/700	160	1100	7500	30	OptiFuse FR-S30-690V-160A-D11	345723
	S30	690/700	200	2200	15000	35	OptiFuse FR-S30-690V-200A-D11	345724
	S30	690/700	250	4200	28500	40	OptiFuse FR-S30-690V-250A-D11	345725
	S30	690/700	315	7000	46500	50	OptiFuse FR-S30-690V-315A-D11	345726
	S30	690/700	350	10000	68500	55	OptiFuse FR-S30-690V-350A-D11	345727
	S30	690/700	400	15000	105000	60	OptiFuse FR-S30-690V-400A-D11	345728
	S30	690/700	450	21000	140000	65	OptiFuse FR-S30-690V-450A-D11	345729
	S30	690/700	500	27000	180000	70	OptiFuse FR-S30-690V-500A-D11	345730
	S31	690/700	200	1650	11500	45	OptiFuse FR-S31-690V-200A-D11	345759
	S31	690/700	250	3100	21000	55	OptiFuse FR-S31-690V-250A-D11	345760
	S31	690/700	315	6200	42000	58	OptiFuse FR-S31-690V-315A-D11	345761
	S31	690/700	350	8500	59000	60	OptiFuse FR-S31-690V-350A-D11	345762
	S31	690/700	400	13500	91500	65	OptiFuse FR-S31-690V-400A-D11	345763
	S31	690/700	450	17000	120000	70	OptiFuse FR-S31-690V-450A-D11	345764
	S31	690/700	500	25000	170000	72	OptiFuse FR-S31-690V-500A-D11	345765
	S31	690/700	550	34000	230000	75	OptiFuse FR-S31-690V-550A-D11	345766
	S31	690/700	630	52000	350000	80	OptiFuse FR-S31-690V-630A-D11	345767
	S31	690/700	700	69500	465000	85	OptiFuse FR-S31-690V-700A-D11	345768
	S31	690/700	800	105000	725000	95	OptiFuse FR-S31-690V-800A-D11	345769
	S32	550	900	160000	800000	99	OptiFuse FR-S31-550V-900A-D11	345770
	S32	690/700	315	6000	40000	55	OptiFuse FR-S32-690V-315A-D11	345787
	S32	690/700	350	8000	55000	60	OptiFuse FR-S32-690V-350A-D11	345788
	S32	690/700	400	11000	74000	65	OptiFuse FR-S32-690V-400A-D11	345789
	S32	690/700	450	15500	105000	70	OptiFuse FR-S32-690V-450A-D11	345790
	S32	690/700	500	21500	145000	75	OptiFuse FR-S32-690V-500A-D11	345791
	S32	690/700	550	28000	190000	80	OptiFuse FR-S32-690V-550A-D11	345792
	S32	690/700	630	41000	275000	90	OptiFuse FR-S32-690V-630A-D11	345793
	S32	690/700	700	60500	405000	95	OptiFuse FR-S32-690V-700A-D11	345794
	S32	690/700	800	86000	575000	105	OptiFuse FR-S32-690V-800A-D11	345795
	S32	690/700	900	125000	840000	110	OptiFuse FR-S32-690V-900A-D11	345796
	S32	690/700	1000	180000	1250000	115	OptiFuse FR-S32-690V-1000A-D11	345797
	S32	600	1100	245000	1600000	120	OptiFuse FR-S32-600V-1100A-D11	345798
	S32	550	1250	365000	2400000	130	OptiFuse FR-S32-550V-1250A-D11	345799
	S33	690/700	450	13500	85000	70	OptiFuse FR-S33-690V-450A-D11	345832
	S33	690/700	500	14000	95000	95	OptiFuse FR-S33-690V-500A-D11	345833
	S33	690/700	550	19500	135000	100	OptiFuse FR-S33-690V-550A-D11	345834
	S33	690/700	630	31000	210000	105	OptiFuse FR-S33-690V-630A-D11	345835
	S33	690/700	700	44500	300000	110	OptiFuse FR-S33-690V-700A-D11	345836
	S33	690/700	800	69500	465000	115	OptiFuse FR-S33-690V-800A-D11	345837
	S33	690/700	900	100000	670000	120	OptiFuse FR-S33-690V-900A-D11	345838
	S33	690/700	1000	140000	945000	125	OptiFuse FR-S33-690V-1000A-D11	345839
	S33	690/700	1100	190000	1300000	130	OptiFuse FR-S33-690V-1100A-D11	345840
	S33	690/700	1250	290000	1950000	140	OptiFuse FR-S33-690V-1250A-D11	345841
	S33	690/700	1400	370000	3100000	155	OptiFuse FR-S33-690V-1400A-D11	345842
	S33	600	1500	450000	3500000	158	OptiFuse FR-S33-600V-1500A-D11	345843
	S33	600	1600	580000	3900000	160	OptiFuse FR-S33-600V-1600A-D11	345844
	S33	600	1800	880000	5250000	165	OptiFuse FR-S33-600V-1800A-D11	345845
	S33	550	2000	1150000	6350000	175	OptiFuse FR-S33-550V-2000A-D11	345846

OptiFuse FR S70, S71, S72, S73. Тип присоединения TF.

Внешний вид	Габарит	Номинальное напряжение AC, Un, В	Номинальный ток, А	I ² t (А ² · с)		Рассеиваемая мощность, Вт	Наименование	Артикул
				Время плавления, с	Разрыв цепи при Un, А			
	S70	1250	50	130	820	20	OptiFuse FR-S70-1250V-50A-TF	345847
	S70	1250	63	210	310	25	OptiFuse FR-S70-1250V-63A-TF	345848
	S70	1250	80	450	2750	30	OptiFuse FR-S70-1250V-80A-TF	345849
	S70	1250	100	860	5100	35	OptiFuse FR-S70-1250V-100A-TF	345850
	S70	1250	125	1430	8560	40	OptiFuse FR-S70-1250V-125A-TF	345851
	S70	1250	160	2820	17450	45	OptiFuse FR-S70-1250V-160A-TF	345852
	S70	1250	200	4930	29400	48	OptiFuse FR-S70-1250V-200A-TF	345853
	S70	1250	250	9510	56800	50	OptiFuse FR-S70-1250V-250A-TF	345854
	S70	1250	280	14000	75000	55	OptiFuse FR-S70-1250V-280A-TF	345855
	S70	1250	315	21440	130000	60	OptiFuse FR-S70-1250V-315A-TF	345856
	S70	1250	350	28900	174500	65	OptiFuse FR-S70-1250V-350A-TF	345857
	S70	1250	400	42000	249600	70	OptiFuse FR-S70-1250V-400A-TF	345858
	S70	1100	450	45000	264500	80	OptiFuse FR-S70-1100V-450A-TF	345859
S70	1000	500	60000	330000	85	OptiFuse FR-S70-1000V-500A-TF	345860	
	S71	1250	160	2200	13600	40	OptiFuse FR-S71-1250V-160A-TF	345861
	S71	1250	200	4150	24000	45	OptiFuse FR-S71-1250V-200A-TF	345862
	S71	1250	250	7750	46000	52	OptiFuse FR-S71-1250V-250A-TF	345863
	S71	1250	280	11000	67000	56	OptiFuse FR-S71-1250V-280A-TF	345864
	S71	1250	315	16500	98400	60	OptiFuse FR-S71-1250V-315A-TF	345865
	S71	1250	350	21500	132000	65	OptiFuse FR-S71-1250V-350A-TF	345866
	S71	1250	400	31000	185000	70	OptiFuse FR-S71-1250V-400A-TF	345867
	S71	1250	450	44500	265000	80	OptiFuse FR-S71-1250V-450A-TF	345868
	S71	1250	500	63000	375000	85	OptiFuse FR-S71-1250V-500A-TF	345869
	S71	1250	550	84500	500000	90	OptiFuse FR-S71-1250V-550A-TF	345870
	S71	1250	630	126000	755000	98	OptiFuse FR-S71-1250V-630A-TF	345871
	S71	1000	700	140000	800000	115	OptiFuse FR-S71-1000V-700A-TF	345872
	S71	900	800	210000	1300000	125	OptiFuse FR-S71-900V-800A-TF	345873
S71	800	900	260000	1700000	145	OptiFuse FR-S71-800V-900A-TF	345874	
S71	750	1000	370000	2100000	150	OptiFuse FR-S71-750V-1000A-TF	345875	
	S72	1250	250	6750	40000	65	OptiFuse FR-S72-1250V-250A-TF	345887
	S72	1250	315	13500	81500	75	OptiFuse FR-S72-1250V-315A-TF	345888
	S72	1250	350	16500	99000	80	OptiFuse FR-S72-1250V-350A-TF	345889
	S72	1250	400	26000	155000	85	OptiFuse FR-S72-1250V-400A-TF	345890
	S72	1250	450	35500	210000	90	OptiFuse FR-S72-1250V-450A-TF	345891
	S72	1250	500	49500	295000	95	OptiFuse FR-S72-1250V-500A-TF	345892
	S72	1250	550	66000	390000	100	OptiFuse FR-S72-1250V-550A-TF	345893
	S72	1250	630	93500	555000	110	OptiFuse FR-S72-1250V-630A-TF	345894
	S72	1100	700	130000	770000	115	OptiFuse FR-S72-1100V-700A-TF	345895
	S72	1100	800	195000	1200000	125	OptiFuse FR-S72-1100V-800A-TF	345896
	S72	1000	900	250000	1500000	145	OptiFuse FR-S72-1000V-900A-TF	345897
	S72	850	1000	340000	2050000	150	OptiFuse FR-S72-850V-1000A-TF	345898
		S73	1250	315	9200	54500	90	OptiFuse FR-S73-1250V-315A-TF
S73		1250	350	13000	77500	95	OptiFuse FR-S73-1250V-350A-TF	345913
S73		1250	400	19000	115000	105	OptiFuse FR-S73-1250V-400A-TF	345914
S73		1250	450	27000	160000	107	OptiFuse FR-S73-1250V-450A-TF	345915
S73		1250	500	37500	225000	110	OptiFuse FR-S73-1250V-500A-TF	345916
S73		1250	550	52000	310000	115	OptiFuse FR-S73-1250V-550A-TF	345917
S73		1250	630	82500	490000	120	OptiFuse FR-S73-1250V-630A-TF	345918
S73		1250	700	115000	700000	125	OptiFuse FR-S73-1250V-700A-TF	345919
S73		1250	800	170000	1050000	135	OptiFuse FR-S73-1250V-800A-TF	345920
S73		1250	900	250000	1500000	145	OptiFuse FR-S73-1250V-900A-TF	345921
S73		1000	1000	340000	2050000	150	OptiFuse FR-S73-1000V-1000A-TF	345922
S73		950	1100	460000	2750000	155	OptiFuse FR-S73-950V-1100A-TF	345923
S73		950	1250	575000	3400000	175	OptiFuse FR-S73-950V-1250A-TF	345924
S73	850	1400	795000	4200000	185	OptiFuse FR-S73-850V-1400A-TF	345925	

OptiFuse FR S70, S71, S72, S73. Тип присоединения D11.

Внешний вид	Габарит	Номинальное напряжение АС, Un, В	Номинальный ток, А	I ² t (А ² · с)		Рассеиваемая мощность, Вт	Наименование	Артикул
				Время плавления, с	Разрыв цепи при Un, А			
	S70	1250	50	130	820	20	OptiFuse FR-S70-1250V-50A-D11	347689
	S70	1250	63	210	310	25	OptiFuse FR-S70-1250V-63A-D11	347690
	S70	1250	80	450	2750	30	OptiFuse FR-S70-1250V-80A-D11	347691
	S70	1250	100	860	5100	35	OptiFuse FR-S70-1250V-100A-D11	347692
	S70	1250	125	1430	8560	40	OptiFuse FR-S70-1250V-125A-D11	347693
	S70	1250	160	2820	17450	45	OptiFuse FR-S70-1250V-160A-D11	347694
	S70	1250	200	4930	29400	48	OptiFuse FR-S70-1250V-200A-D11	347695
	S70	1250	250	9510	56800	50	OptiFuse FR-S70-1250V-250A-D11	347696
	S70	1250	280	14000	75000	55	OptiFuse FR-S70-1250V-280A-D11	347697
	S70	1250	315	21440	130000	60	OptiFuse FR-S70-1250V-315A-D11	347698
	S70	1250	350	28900	174500	65	OptiFuse FR-S70-1250V-350A-D11	347699
	S71	1250	400	42000	249600	70	OptiFuse FR-S70-1250V-400A-D11	347700
	S71	1250	160	2200	13600	40	OptiFuse FR-S71-1250V-160A-D11	345876
	S71	1250	200	4150	24000	45	OptiFuse FR-S71-1250V-200A-D11	345877
	S71	1250	250	7750	46000	52	OptiFuse FR-S71-1250V-250A-D11	345878
	S71	1250	280	11000	67000	56	OptiFuse FR-S71-1250V-280A-D11	345879
	S71	1250	315	16500	98400	60	OptiFuse FR-S71-1250V-315A-D11	345880
	S71	1250	350	21500	132000	65	OptiFuse FR-S71-1250V-350A-D11	345881
	S71	1250	400	31000	185000	70	OptiFuse FR-S71-1250V-400A-D11	345882
	S71	1250	450	44500	265000	80	OptiFuse FR-S71-1250V-450A-D11	345883
	S71	1250	500	63000	375000	85	OptiFuse FR-S71-1250V-500A-D11	345884
	S71	1250	550	84500	500000	90	OptiFuse FR-S71-1250V-550A-D11	345885
S71	1100	630	126000	755000	98	OptiFuse FR-S71-1100V-630A-D11	345886	
	S72	1250	250	6750	40000	65	OptiFuse FR-S72-1250V-250A-D11	345899
	S72	1250	280	9000	65000	70	OptiFuse FR-S72-1250V-280A-D11	345900
	S72	1250	315	13500	81500	75	OptiFuse FR-S72-1250V-315A-D11	345901
	S72	1250	350	16500	99000	80	OptiFuse FR-S72-1250V-350A-D11	345902
	S72	1250	400	26000	155000	85	OptiFuse FR-S72-1250V-400A-D11	345903
	S72	1250	450	35500	210000	90	OptiFuse FR-S72-1250V-450A-D11	345904
	S72	1250	500	49500	295000	95	OptiFuse FR-S72-1250V-500A-D11	345905
	S72	1250	550	66000	390000	100	OptiFuse FR-S72-1250V-550A-D11	345906
	S72	1250	630	93500	555000	110	OptiFuse FR-S72-1250V-630A-D11	345907
	S72	1250	700	130000	770000	115	OptiFuse FR-S72-1250V-700A-D11	345908
	S72	1250	800	195000	1200000	125	OptiFuse FR-S72-1250V-800A-D11	345909
	S72	1100	900	250000	1500000	145	OptiFuse FR-S72-1100V-900A-D11	345910
	S72	1100	1000	340000	2050000	150	OptiFuse FR-S72-1100V-1000A-D11	345911
		S73	1250	315	9200	54500	90	OptiFuse FR-S73-1250V-315A-D11
S73		1250	350	13000	77500	95	OptiFuse FR-S73-1250V-350A-D11	345927
S73		1250	400	19000	115000	105	OptiFuse FR-S73-1250V-400A-D11	345928
S73		1250	450	27000	160000	107	OptiFuse FR-S73-1250V-450A-D11	345929
S73		1250	500	37500	225000	110	OptiFuse FR-S73-1250V-500A-D11	345930
S73		1250	550	52000	310000	115	OptiFuse FR-S73-1250V-550A-D11	345931
S73		1250	630	82500	490000	120	OptiFuse FR-S73-1250V-630A-D11	345932
S73		1250	700	115000	700000	125	OptiFuse FR-S73-1250V-700A-D11	345933
S73		1250	800	170000	1050000	135	OptiFuse FR-S73-1250V-800A-D11	345934
S73		1250	900	250000	1500000	145	OptiFuse FR-S73-1250V-900A-D11	345935
S73		1250	1000	340000	2050000	150	OptiFuse FR-S73-1250V-1000A-D11	345936
S73		1250	1100	460000	2750000	155	OptiFuse FR-S73-1250V-1100A-D11	345937
S73		1100	1250	575000	3400000	175	OptiFuse FR-S73-1100V-1250A-D11	345938
S73		1100	1400	795000	4200000	185	OptiFuse FR-S73-1100V-1400A-D11	345939

OptiFuse FR S44. Тип присоединения TF.

Внешний вид	Габарит	Номинальное напряжение AC, Un, В	Номинальный ток, А	I ² t (А ² · с)		Рассеиваемая мощность, Вт	Наименование	Артикул
				Время плавления, с	Разрыв цепи при Un, А			
	S44	690/700	1000	76000	505000	175	OptiFuse FR-S44-690V-1000A-TF	347680
	S44	690/700	1250	145000	965000	195	OptiFuse FR-S44-690V-1250A-TF	347681
	S44	690/700	1400	205000	1400000	205	OptiFuse FR-S44-690V-1400A-TF	347682
	S44	690/700	1600	305000	2050000	220	OptiFuse FR-S44-690V-1600A-TF	347683
	S44	690/700	2000	600000	3950000	245	OptiFuse FR-S44-690V-2000A-TF	347684
	S44	690/700	2500	1200000	7800000	275	OptiFuse FR-S44-690V-2500A-TF	347685
	S44	690/700	3000	2000000	13500000	305	OptiFuse FR-S44-690V-3000A-TF	347686
	S44	690/700	3500	3250000	22000000	325	OptiFuse FR-S44-690V-3500A-TF	347687
	S44	600	4000	4700000	28000000	355	OptiFuse FR-S44-600V-4000A-TF	347688

OptiFuse FR S84. Тип присоединения TF.



	S84	1250	1000	180000	1100000	195	OptiFuse FR-S84-1250V-1000A-TF	347701
	S84	1250	1100	250000	1500000	200	OptiFuse FR-S84-1250V-1100A-TF	347702
	S84	1250	1500	600000	3600000	250	OptiFuse FR-S84-1250V-1500A-TF	347703
	S84	1250	1700	850000	5000000	260	OptiFuse FR-S84-1250V-1700A-TF	347704
	S84	1250	1800	1000000	5950000	265	OptiFuse FR-S84-1250V-1800A-TF	347705
	S84	1250	2000	1450000	8600000	270	OptiFuse FR-S84-1250V-2000A-TF	347706
	S84	1250	2200	2000000	12000000	280	OptiFuse FR-S84-1250V-2200A-TF	347707
	S84	1250	2500	3000000	18000000	295	OptiFuse FR-S84-1250V-2500A-TF	347708

► **Технические характеристики**

Параметр	Значение
Номинальное напряжение Un (AC), В	450 – 1250
Номинальный ток In, А	40 – 4000
Предельная коммутационная способность, кА	100
Категория применения предохранителя	aR
Тип присоединения	TF — потайные контактные колпачки; D08, D11 — контактные ножи
Соответствие стандартам	TP TC 004/2011, ГОСТ IEC 60269-1-2016, ГОСТ IEC 60269-4-2016
Группа условий эксплуатации (ГОСТ 30631-99)	M39, M25
Степень защиты	IP00
Климатическое исполнение	УХЛ3
Диапазон рабочих температур, °С	от -40 до +90

► **Аксессуары**

Свободные контакты OptiFuse FR

Внешний вид	Номинальное напряжение AC, Un, В	Номинальный ток, А	Наименование	Артикул
	250	5	OptiFuse FR-FRX26	357515
	250	5	OptiFuse FR-FRX6	357516

Серия предохранителя	Наименование доп. контакта
OptiFuse FR-S30 OptiFuse FR-S31 OptiFuse FR-S32 OptiFuse FR-S33 OptiFuse FR-S44	FRX6 250V
OptiFuse FR-S70 OptiFuse FR-S71 OptiFuse FR-S72 OptiFuse FR-S73 OptiFuse FR-S84 OptiFuse FR-S94 OptiFuse FR-S273	FRX26 250V / FRX6 250V

► Габаритные размеры (мм)

OptiFuse FR S30, S31, S32, S33. Тип присоединения TF.

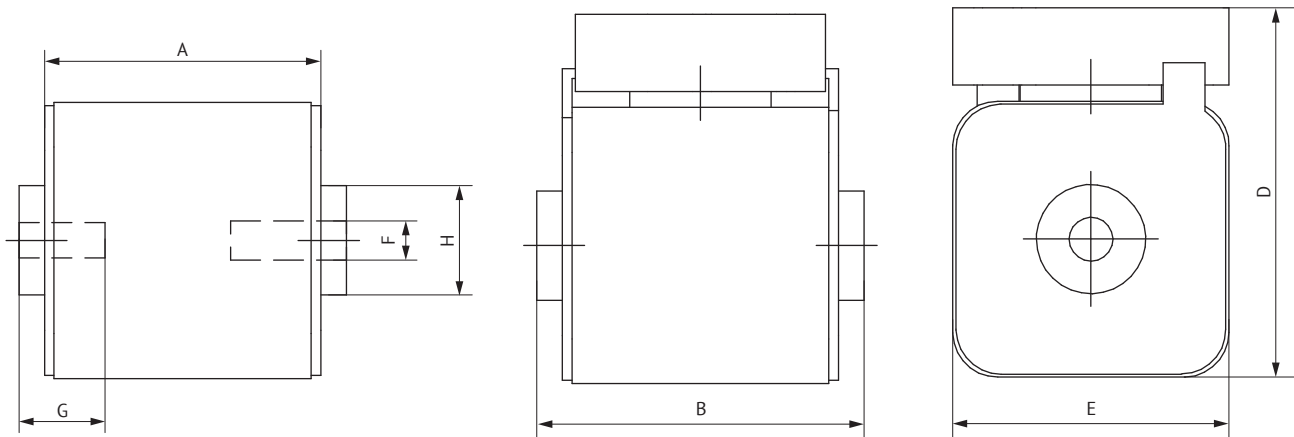

Габарит	Размеры						
	A (Max)	B	D	E	F	G	H
S30	50	51	43 (59)	43	M8	5	17
S31	50	51	50 (69)	50	M8	8	20
	50	51	50 (69)	50	M8	8	20
S32	50	51	60 (77)	60	M10	10	24
	50	65	60 (77)	60	M10	10	24
S33	50	51	75 (92)	75	M12	12	40
	50	65	75 (92)	75	M12	12	40
	50	65	75 (92)	75	M12	12	40
	50	65	75 (92)	75	M12	12	40
	50	65	75 (92)	75	M12	12	40

OptiFuse FR S30, S31, S32, S33. Тип присоединения D08 и D11.

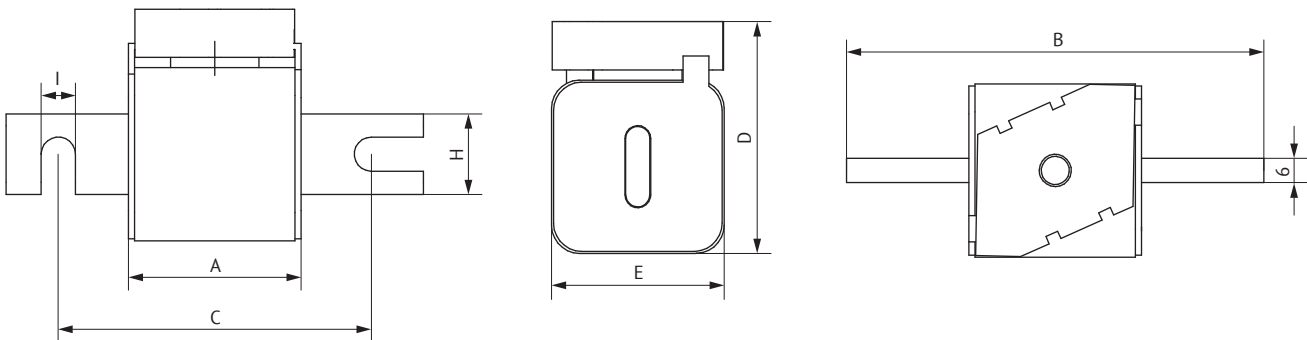

Габарит	Размеры						
	A (Max)	B	C	D	E	H	I
S30-D08/S30-D11	50	104/134	78/104	59	43	20	8
S31-D08/S31-D11	50	108/138	78/108	69	51	25	11
S32-D08/S32-D11	50	108/138	78/108	77	60	25	11
S33-D08/S33-D11	50	108/138	78/108	92	75	30	11

OptiFuse FR S70, S71, S72, S73. Тип присоединения TF.

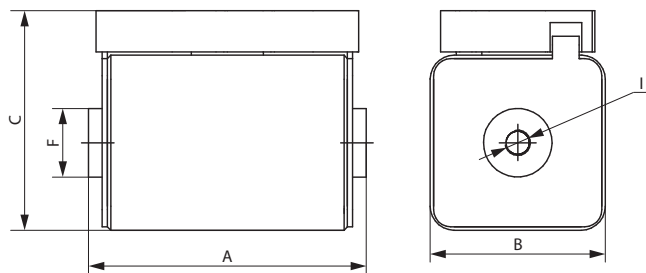

Габарит	Размеры				
	A	B	C	F	I
S70	81±2	43±2	61±3	17±1	M8x10
S71	81±2	51±2	67±3	20±1	M8x10
S72	81±2	60±2	76±3	24±1	M10x12
S73	81±2/91±2 (1250A - 1600A)	75±2	92±3	40±1	M12x10

OptiFuse FR S70, S71, S72, S73. Тип присоединения D11.

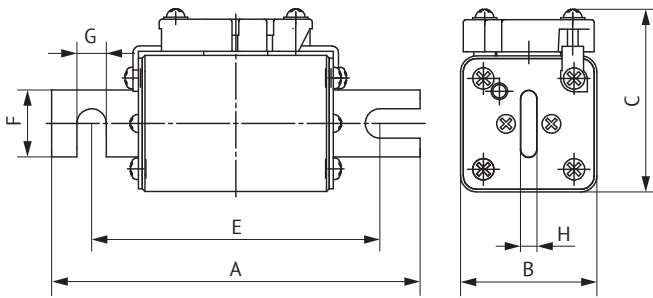

Габарит	Размеры						
	A	B	C	E	F	G	H
S70	134±2	43±2	61±3	108±2,5	17±1	8	6
S71	138±2	51±2	67±3	108±2,5	20±1	11	6
S72	138±2	60±2	76±3	108±2,5	24±1	11	6
S73	166±2	75±2	92±3	108±2,5	40±1	11	6

OptiFuse FR-S44

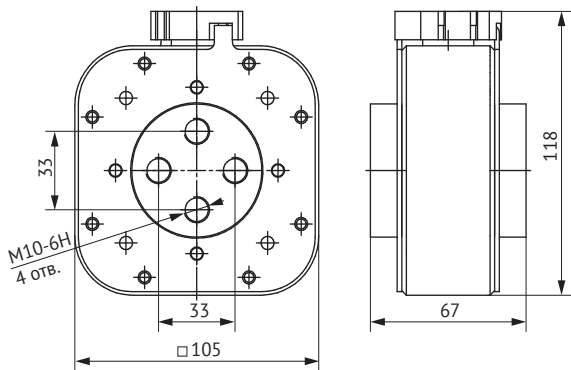

OptiFuse FR S84. Тип присоединения TF.

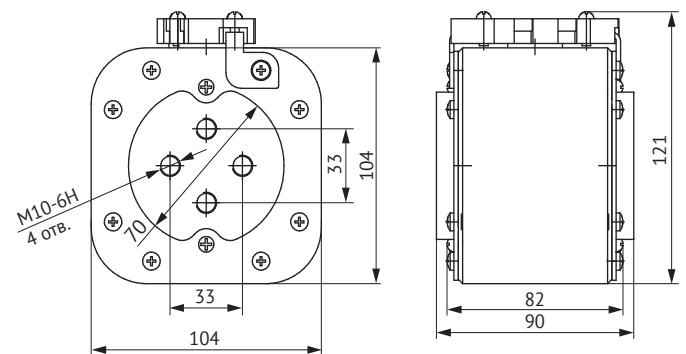

OptiFuse FR FRX6 и FRX26

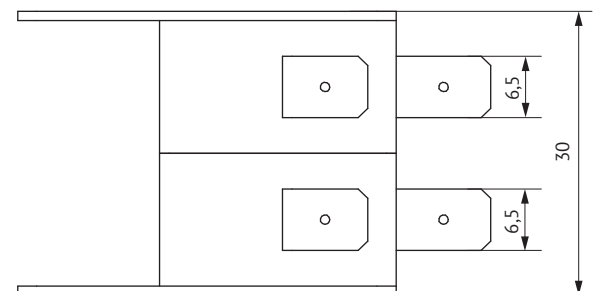
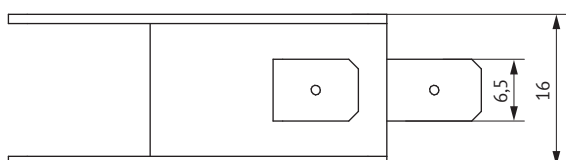
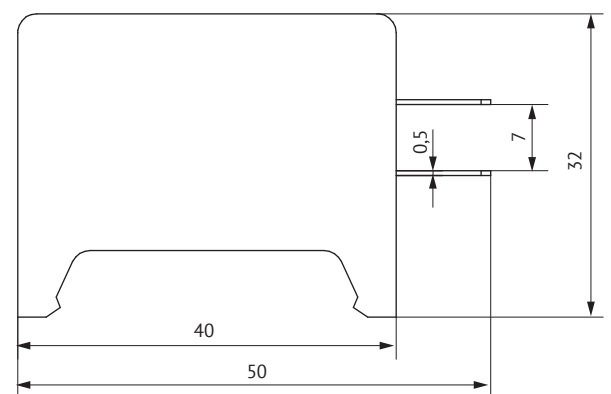
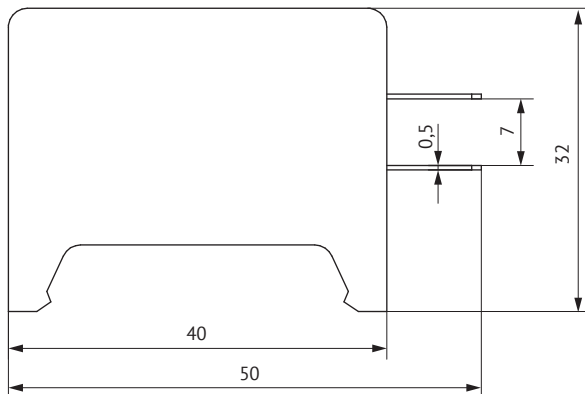

Примечание: размеры указаны в мм.

► Время-токовые характеристики

ВТХ как полного отключения так и плавления для габарита S30

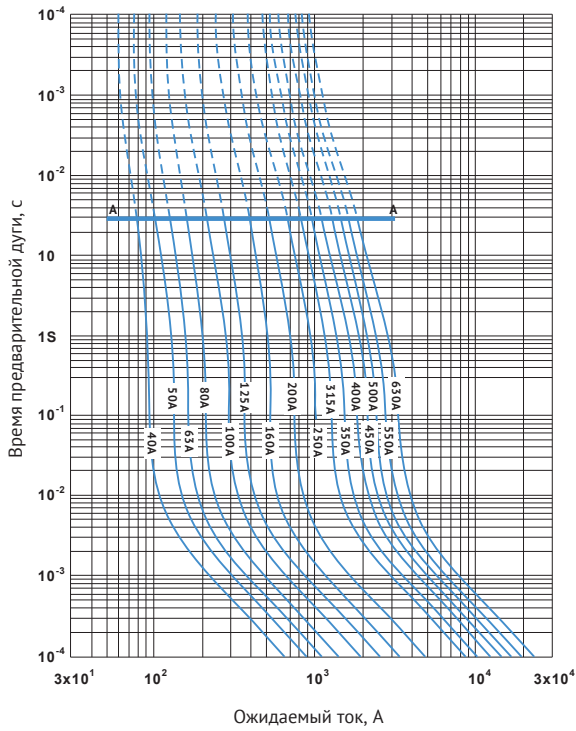

ВТХ как полного отключения так и плавления для габарита S31

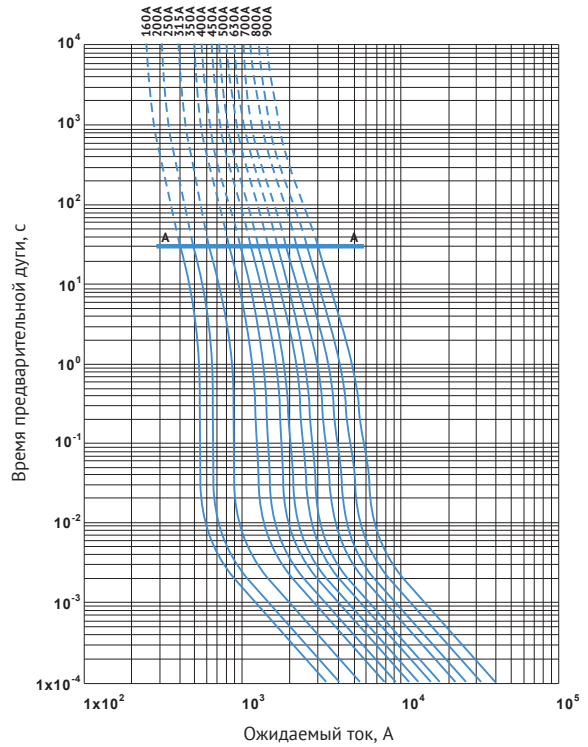

Амплитуды пропускаемого тока в зависимости от ожидаемого тока КЗ для габарита S30

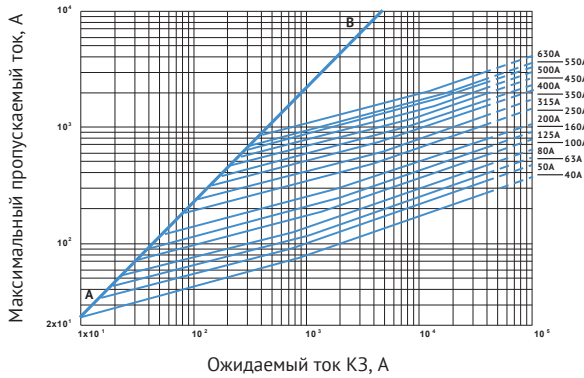

Амплитуды пропускаемого тока в зависимости от ожидаемого тока КЗ для габарита S31

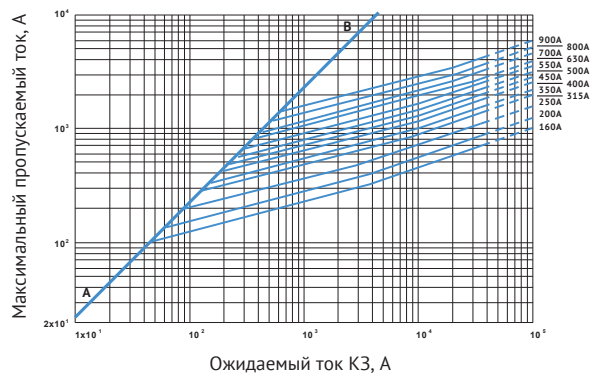

ВТХ как полного отключения так и плавления для габарита S32

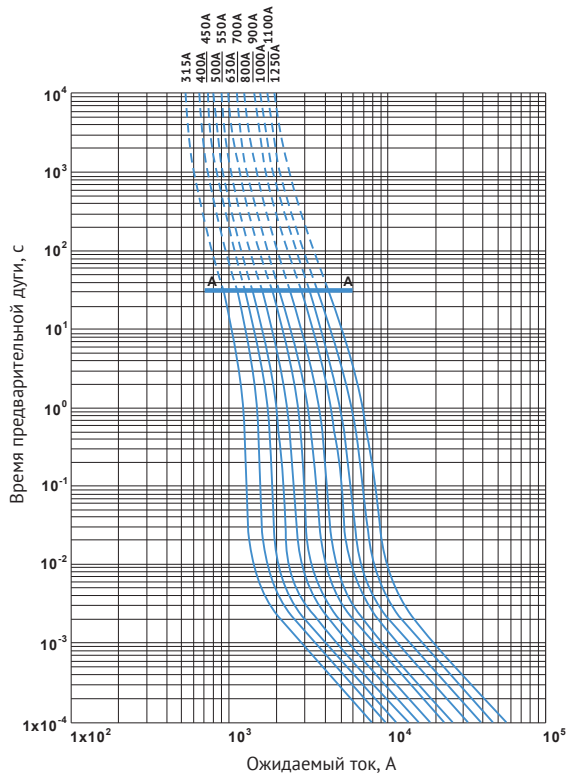

ВТХ как полного отключения так и плавления для габарита S33

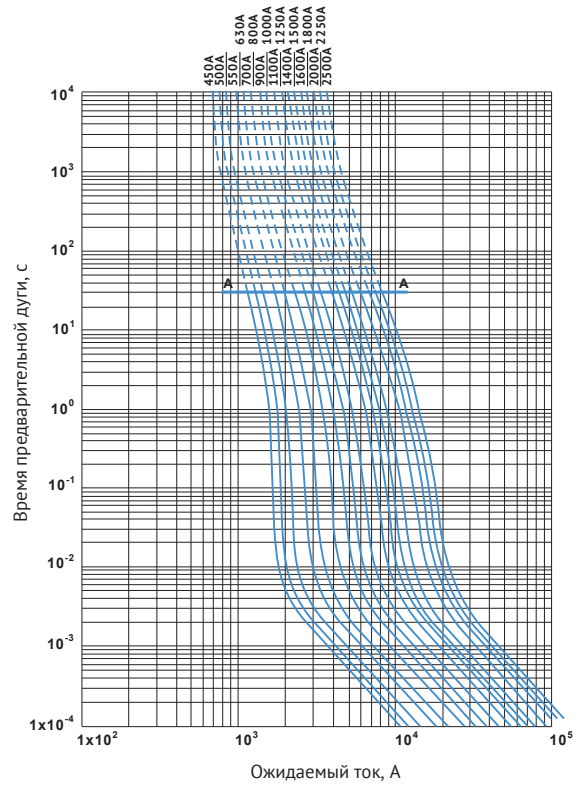

Амплитуды пропускаемого тока в зависимости от ожидаемого тока КЗ для габарита S32

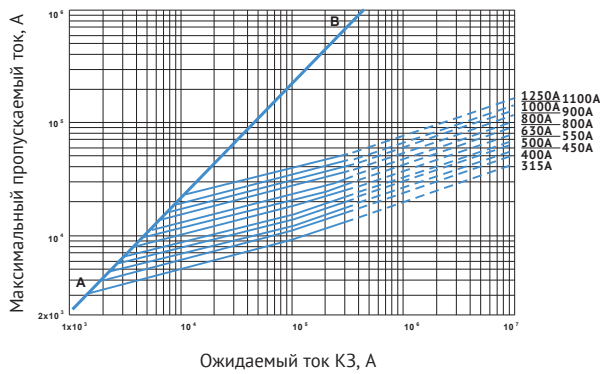

Амплитуды пропускаемого тока в зависимости от ожидаемого тока КЗ для габарита S33

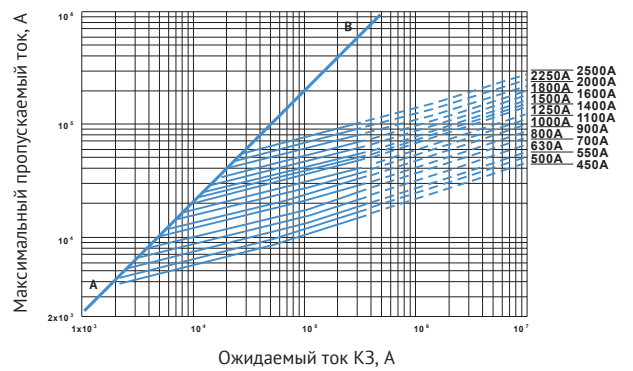

ВТХ как полного отключения так и плавления для габарита S70

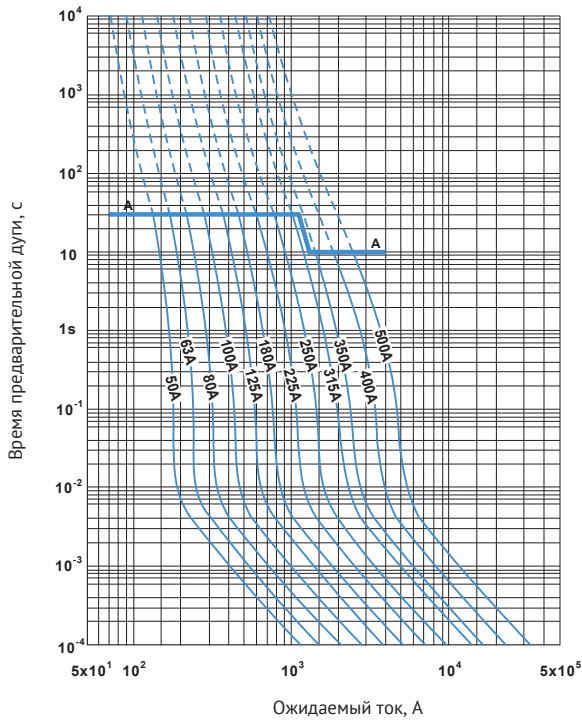

ВТХ как полного отключения так и плавления для габарита S71

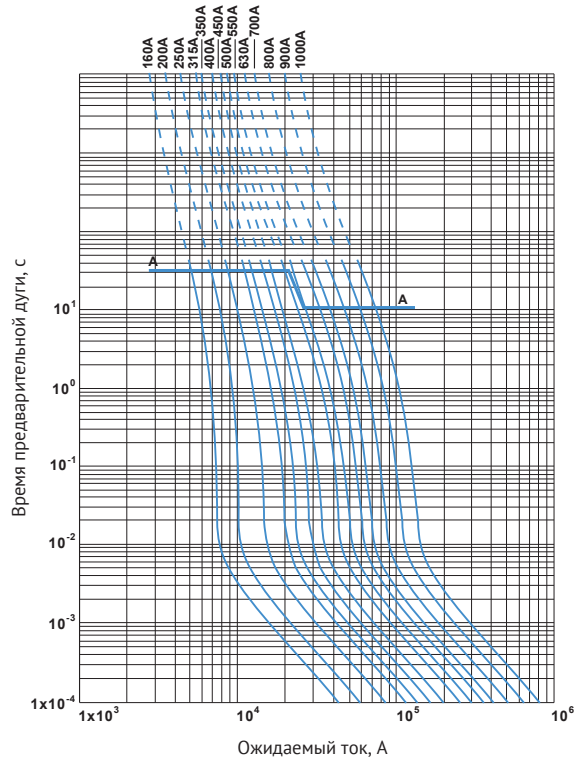

Амплитуды пропускаемого тока в зависимости от ожидаемого тока КЗ для габарита S70

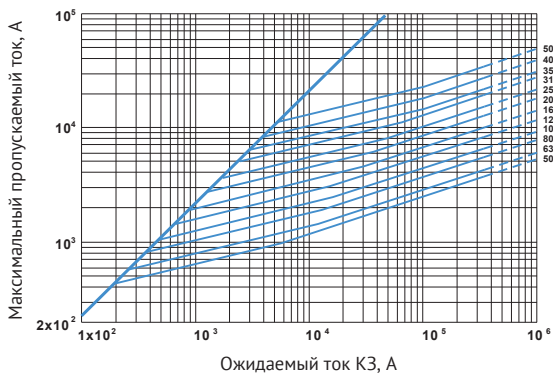

Амплитуды пропускаемого тока в зависимости от ожидаемого тока КЗ для габарита S71

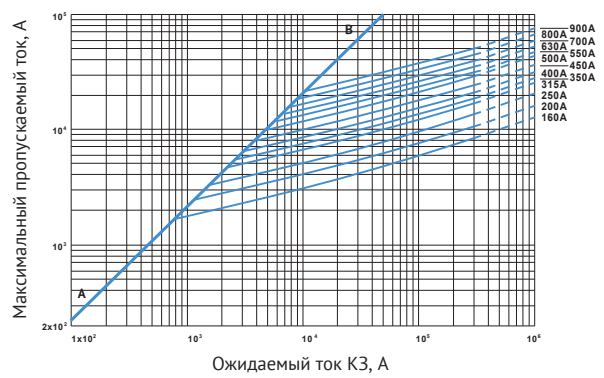

ВТХ как полного отключения так и плавления для габарита S72

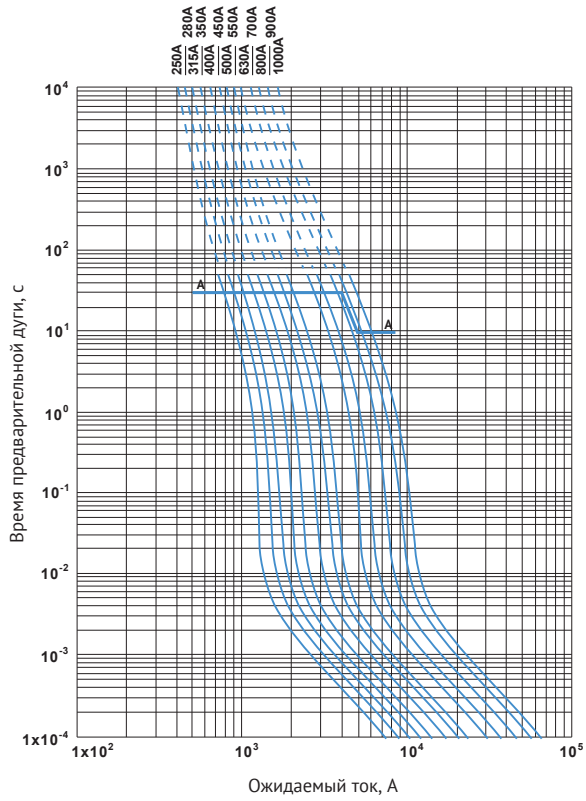

ВТХ как полного отключения так и плавления для габарита S73

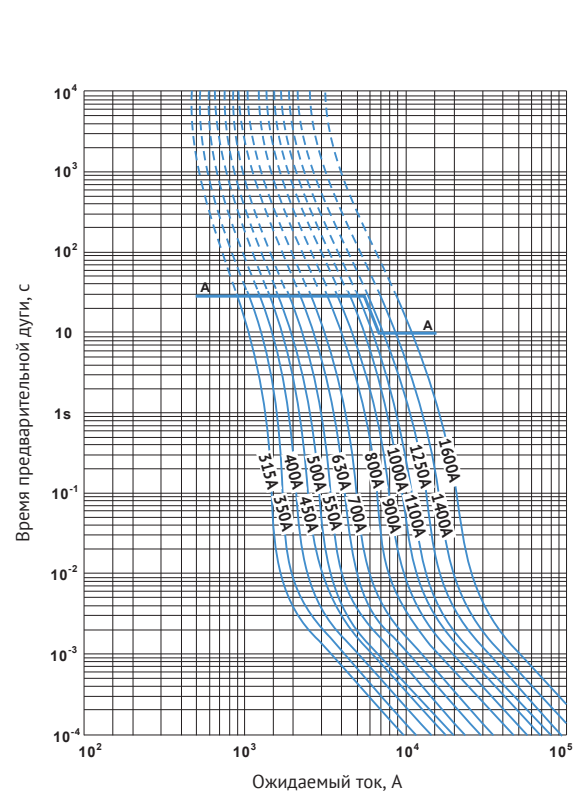

Амплитуды пропускаемого тока в зависимости от ожидаемого тока КЗ для габарита S72

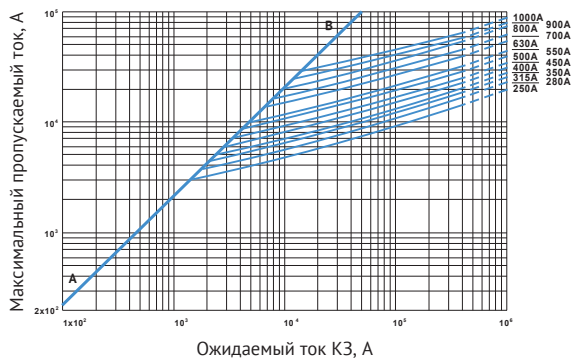

Амплитуды пропускаемого тока в зависимости от ожидаемого тока КЗ для габарита S73

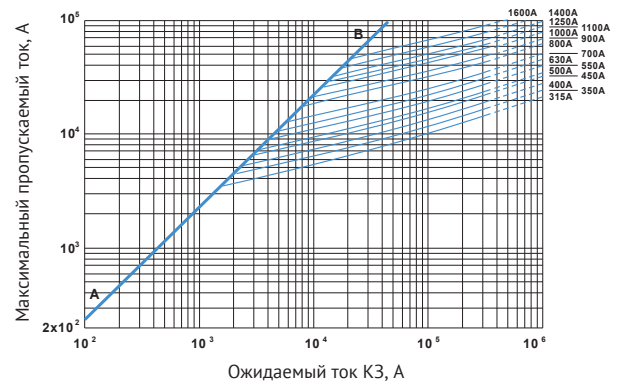

ВТХ как полного отключения так и плавления для габарита S44

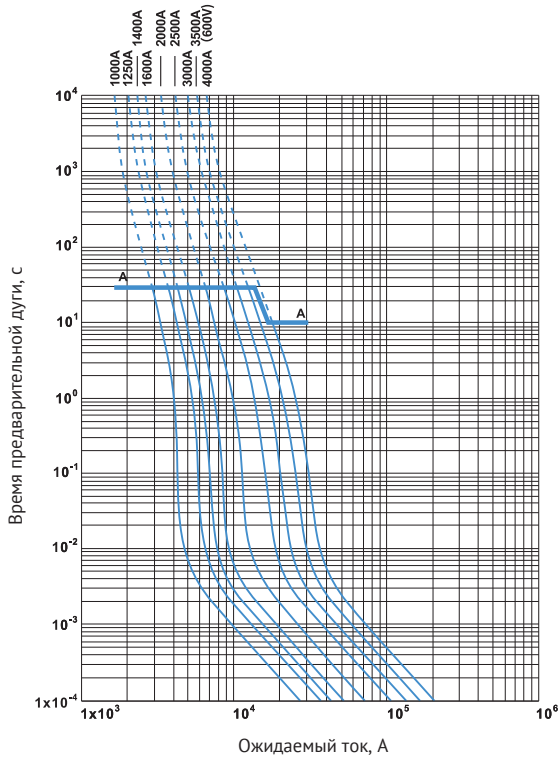

ВТХ как полного отключения так и плавления для габарита S84

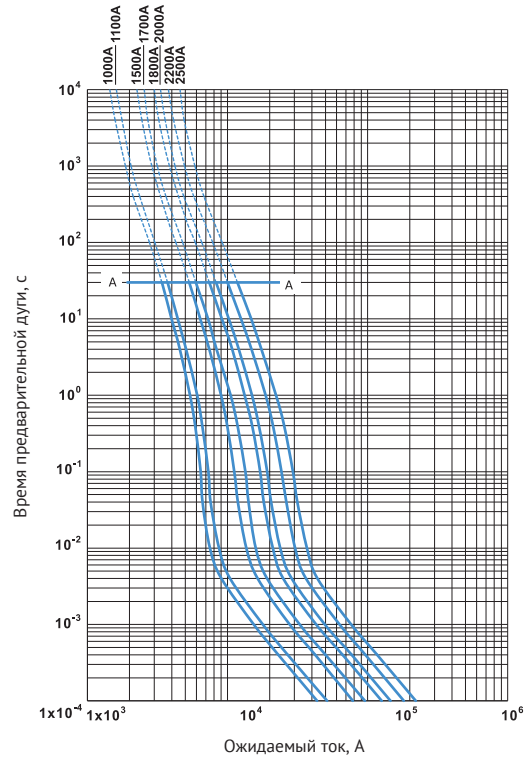

Амплитуды пропускаемого тока в зависимости от ожидаемого тока КЗ для габарита S44

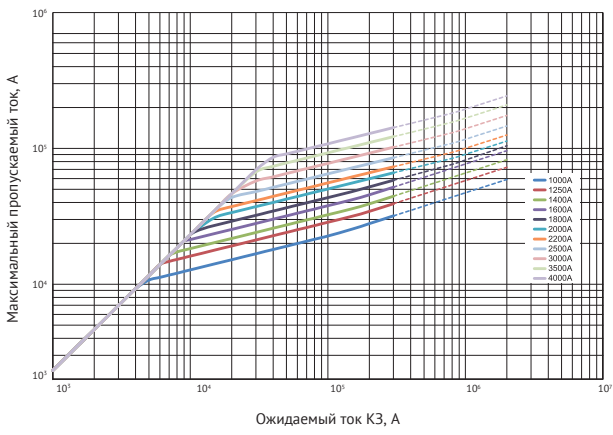

Амплитуды пропускаемого тока в зависимости от ожидаемого тока КЗ для габарита S44

