

工业自动化紧固专家

2024-2025

INDUSTRIAL AUTOMATION
FASTENING EXPERT

SGS® INDUSTRIAL
BITS
工业批头

The Source Factory
源头工厂

Specializing in the production of
S2 high-end bits
专业生产S2高端批头



S2



ONLY DO THE S2 BITS TO
ACHIEVE BETTER QUALITY CONTROL

只做S2批头，为了实现更好的品控

GROWING WITH WORLD MANUFACTURING

与世界制造一起成长



SGS致力于进一步促进全球制造业发展，我们重视责任；不仅仅是对自己的企业，对我们居住的这个世界也是如此。倡导绿色发展理念，自成立之日起，工艺制造技术上的领先始终是公司未来沿革的一部分，SGS作为全球工业系统工具专业批头供应商，永远追求更好的可持续发展，这一信条将会让公司一直居于业内领先地位。今日及至未来，这就是我们SGS，工业级批头专业制造商。

SGS is committed to further advancing global manufacturing, and we take responsibility seriously; not just for our own business, but for the world we live in. Advocating the concept of green development. Since its establishment, the leadership in process manufacturing technology has always been part of the company's future evolution. As a professional supplier of industrial system tools, SGS will always pursue better sustainable development. This creed will It will keep the company in a leading position in the industry. Today and into the future, this is our SGS, a professional manufacturer of industrial bits.



SGS® INDUSTRIAL BITS
工业批头

A legend Tool brand

一个传奇的工具品牌

台州科索工具有限公司是一家集自主研发生产和自营进出口为一体的现代企业，总部位于浙江台州，坐落于美丽的仙居，厂区占地总面积6800平方，建筑总面积8800平方。

台州科索工具致力于生产工业级批头，企业秉承着“专业和不断创新的精神！”在选材上，坚持“制作S2工业级批头”的理念，在制造工艺上，配备了高精度CNC数控自动化机台，2019年耗巨资引进了一流的热处理设备以及精湛的二次回火工艺，在原有的品质基础上实现了质的飞跃。

我们的产品遍布全国各地，远销俄罗斯、美国、日本、德国、伊朗、泰国、印度、巴基斯坦、韩国、非洲、马来西亚等，获得国内外客户一致好评！

竭诚欢迎国内外的朋友莅临我厂参见、指导、洽谈业务！期待与您携手共进，共赢未来！

Taizhou KESUO Tools Co., Ltd. is a modern enterprise integrating independent R D production and self-support import and export. It is headquartered in Taizhou, Zhejiang, located in the beautiful Xianju. The factory covers a total area of 6,800 square meters and a total construction area of 8,800 square meters. Taizhou KESUO Tools is committed to the production of industrial-grade screwdriver bits, and the company adheres to the "spirit of professionalism and continuous innovation!"

In terms of material selection, we adhere to the concept of "making S2 industrial-grade bits". In terms of manufacturing process, we are equipped with high-precision CNC numerical control automatic machines. A qualitative leap has been achieved on the basis of the original quality.

Our products are all over the country and are exported to Russia, the United States, Japan, Germany, Iran, Thailand, India, Pakistan, South Korea, Africa, Malaysia, etc., and have won unanimous praise from domestic and foreign customers!

We sincerely welcome friends at home and abroad to visit our factory to see, guide and negotiate business! We look forward to working with you hand in hand to achieve a win-win future!



我们始终认为：优质的产品，
同样出自一流的生产设备和管理，
以及苛刻的实验。

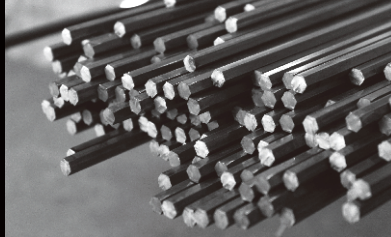

We always believe that : high-quality
products,Also from first-class production equipment
and management, and harsh experiments.



SGS®



传承工匠精神，
将中国制造技术传到世界各地为己任。
我们只制造高标准的批头。

Inherit the craftsman spirit,
It is our duty to spread Chinese manufacturing
technology to all parts of the world.
We only manufacture high standard screwdriver bits.

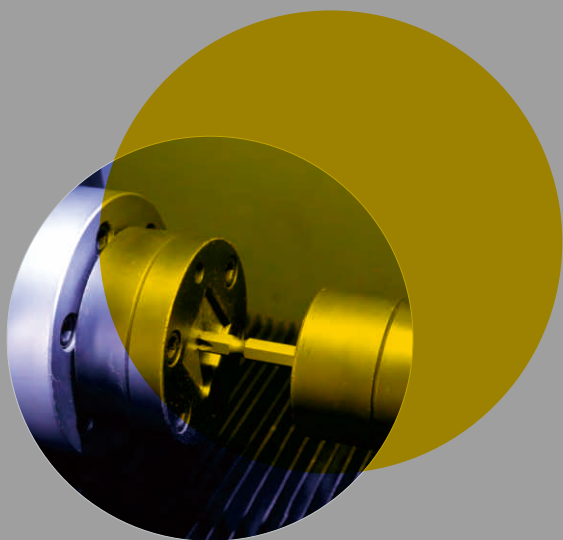

Positioning the global tool industry system
We will participate in major professional
exhibitions in China and abroad,
We can meet the latest manufacturing in the world
and special bits can be customized for you



定位全球工具行业系统
参加国内外各大专业展览，
使我们能够满足全球前沿最新制造的
也可为您定制特殊的专属批头

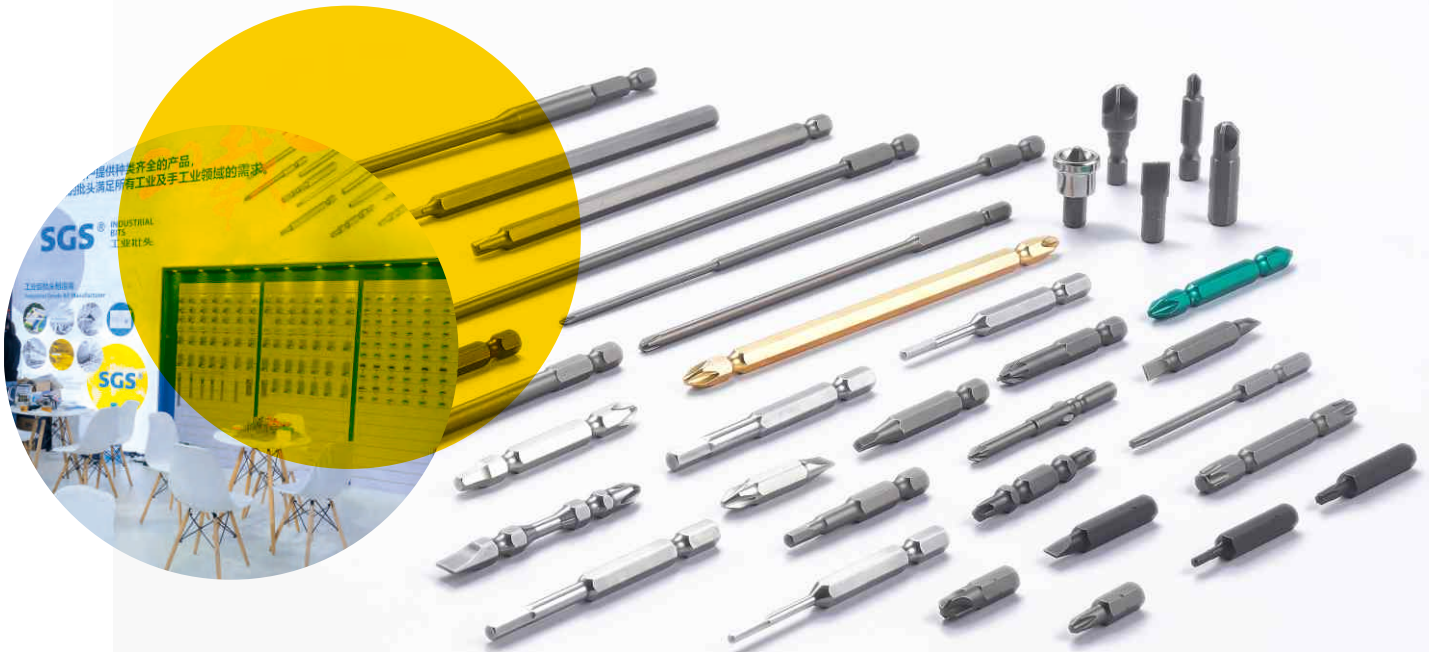



**We can provide customers with
a full range of products,
High-quality bits meet all industries and
Demand in the handcraft industry.**



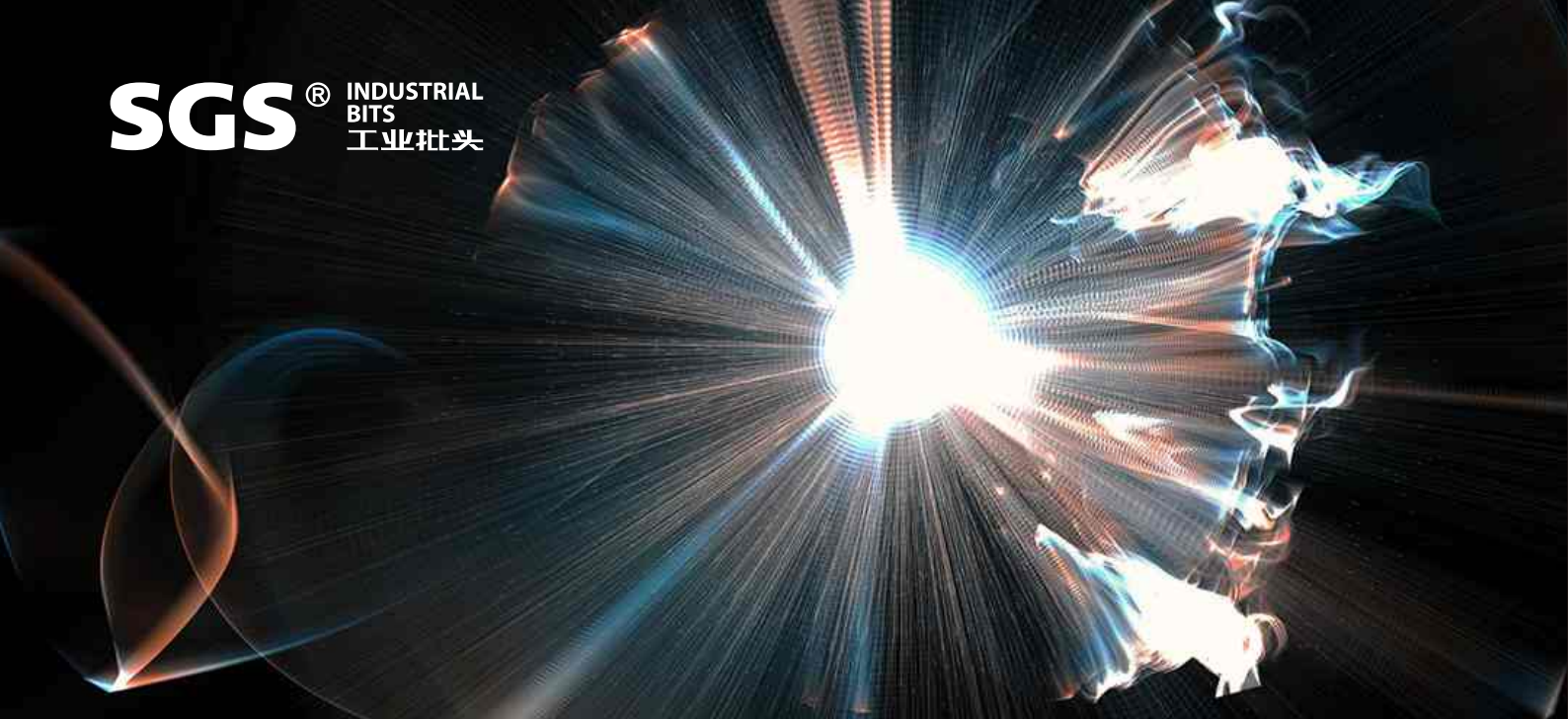

头型批头类型

Bits Types



TRIANGLE



内三角螺丝专用
Inner triangle screw dedicated
用于金属产品的装配、模具、机械、精密仪器、摩托车等
It is mostly used in the assembly, mold, machinery, Precision instruments, motorcycles, etc.



U SHAPE



U型螺丝专用
Special for U-shaped screws
用于金属产品的装配、模具、机械、精密仪器、摩托车等
It is mostly used in the assembly, mold, machinery, Precision instruments, motorcycles, etc.



Y SHAPE



Y型螺丝专用
Special for Y type screws
用于金属产品的装配、模具、机械、精密仪器、摩托车等
It is mostly used in the assembly, mold, machinery, Precision instruments, motorcycles, etc.



SQUARE



内四角螺丝专用
Special for inner corner screws
用于金属产品的装配、模具、机械、精密仪器、摩托车等
It is mostly used in the assembly, mold, machinery, Precision instruments, motorcycles, etc.



HEXAGON



内六角螺丝专用
Special for hexagon socket screws
用于金属产品的装配、模具、机械、精密仪器、摩托车等
It is mostly used in the assembly, mold, machinery, Precision instruments, motorcycles, etc.



POZI



米字螺丝专用
Poizidriv screw special
用于OA设备、计算机、住宅建材、机动车、航空设备等欧洲主流螺丝
It is mostly used in the assembly, mold, machinery, Precision instruments, motorcycles, etc.



TORX



梅花螺丝专用
For Torx screws
用于硬盘、机动车、切削工具、插座等
It is hard disks, motor vehicles, cutting tools, sockets, etc.



PHILLIPS



十字螺丝专用
For Phillips screws
通常市面上普遍最为常见的螺丝
J15B4633美国飞利浦公司的设计。
It is Usually the most common screws on the market J15B4633 is designed by Philips, USA.



SLOTTED



一字螺丝专用
Special for slotted screws
通常用于手表、眼镜、精密仪器等小螺丝。也可用于十字螺丝刀
It is used in watches, glasses, precision instruments, etc. small screws. Can also be used for Phillips screwdrivers



TORX



梅花防盗螺丝专用
Tamper Proof Torx screw dedicated
用于硬盘、机动车、切削工具、插座等
厂家不希望用户拆开的产品上。
It is hard disks, motor vehicles, cutting tools, sockets, etc. Manufacturers do not want users to disassemble the product.



TORQ



万字型螺丝专用
Special for 4D screws
用于金属产品的装配、模具、机械、精密仪器、摩托车等
It is mostly used in the assembly, mold, machinery, Precision instruments, motorcycles, etc.

INDUSTRIAL GRADE BITS MANUFACTURER

工业级批头制造商

目录

Contents



- | | | | |
|-----|---|-----|---|
| 01/ | 组合套装系列
Combination set
Series | 36/ | 单头内六角批头
Single-ended Hexagon
Bits |
| 05/ | 科索系列
K & S series | 39/ | 单头球头批头
Single-ended Spherical
Bits |
| 07/ | 宝得系列
B & D series | 41/ | 单头方形批头
Single-ended Square
Bits |
| 09/ | 双头批头系列
Double head Bits
Series | 43/ | 单头异形批头
Single-ended Special
Shaped Bits |
| 15/ | 冲击批系列
Impact Bits Series | 45/ | 万字批头
Torq Bits |
| 22/ | 防滑批头系列
Anti slip Bits Series | 48/ | 电动批头
Electric Bits |
| 23/ | 竹节批头系列
Bamboo Knot Bits
Series | 51/ | 套筒和接杆
Sleeve & connecting rod |
| 24/ | 电工批头系列
Electrical Bits Series | 58/ | 包装展示
Packaging display |
| 25/ | 单头十字批头
Single-ended Phillips
Bits | 59/ | 客户定制品
Customized products |
| 29/ | 单头一字批头
Single-ended Slotted
Bits | 61/ | 表面处理
Surface treatment style |
| 31/ | 单头梅花批头
Single-ended Torx Bits | | |

全新组合套装A

一盒批头满足家居安装、机电维修等多场景使用需求

A box of screw bits meets the needs of multiple scenarios such as home installation, mechanical and electrical maintenance, etc



磁性

超强的磁性使螺丝牢牢的吸附住螺丝, 大幅提高工作效率。

Magnetism

The super-strong magnetism makes the screw firmly absorb the screw, which greatly improves the work efficiency

多色包装

选择红色盒子或者黑色盒子来为您的产品加分

红.Red



黑.Black



包装盒采用UV印刷

The packaging box is UV printed



42 PCS SGS6342P-1 Combination set



42 PCS S Co



高硬度材料
S2 采用进口S2材料,整体经特殊热处理加工超高扭力输出, HRC61°±1

High hardness material

Imported S2 material used, through special heat treatment processing ultra-high torque output

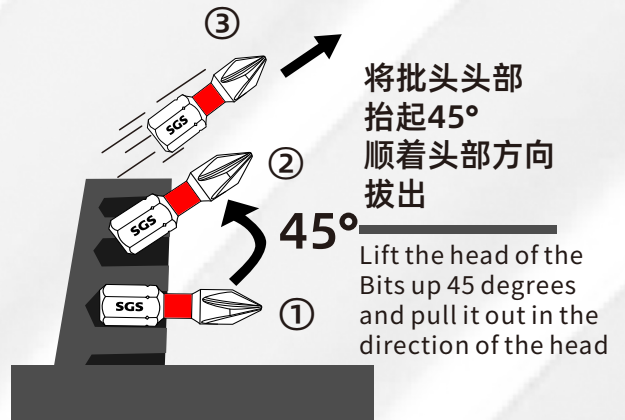

可折叠隔层收纳条
折叠可减少空间、方便取用
Foldable compartment storage strip
Folding can reduce space and facilitate access

LOGO 塑料套管
套管logo可定制

Plastic sleeve
The casing logo can be customized



环保标识
产品严格遵循限制使用Pb(铅)、Cd(镉)、Hg(水银)、六价铬、PBB(多溴联苯)、PBDE(二溴联苯醚)的相关法律法规。

强磁标识

32 PCS SGS6332P-1
Combination set



32 PCS SGS6332P-2
Combination set



42 PCS SGS6342P-2
Combination set



42 PCS SGS6342P-3
Combination set



52 PCS SGS6352P
Combination set



34 PCS SGS6334P
Combination set



44 PCS SGS6344P
Combination set



26 PCS SGS6326P
Combination set



我们制造高标准批头，
种类全面，满足所有工业及手工业领域的需求。

We make high standard bits,
A comprehensive range to meet the needs of all industrial and handicraft industries.

■ 多功能组合套装 (S2材料、种类齐全)/Multi functional combination set (S2 material, complete variety)

42 PCS **SGS6342P-1**
Combination set



规格	长度	数量
十字	25mm	PH1(X8)、PH2(X8)
内六角		H4.0、H5.0
梅花		Torx25、Torx30
方形		SQ2
一字		SL5.0(X3)
十字	65mm	PH2(X11)
十字	90mm	PH2(X3)
带珠接杆	65mm	Q3/8、Q1/4
不锈钢分体接杆	60mm	H1/4
套筒黑磷化双白圈	42mm	H8M

42 PCS **SGS6342P-2**
Combination set



规格	长度	数量
十字	25mm	PH0(X1)、PH1(X1)、PH2(X1)、PH3(X1)
一字		SL3.0(X1)、SL4.0(X1)、SL5.0(X1)、SL6.0(X1)
内六角		H1.5(X1)、H2.0(X1)、H2.5(X1)、H3.0(X1)、H4.0(X1)、H5.0(X1)、H6.0(X1)
梅花带孔		TT8(X1)、TT9(X1)、TT10(X1)、TT15(X1)、TT20(X1)、TT25(X1)、TT27(X1)、TT30(X1)、TT40(X1)
一字	50mm	SL3(X1)、SL4(X1)、SL5(X1)
内六角	50mm	H3.0(X1)、H4.0(X1)、H5.0(X1)
十一字	65mm	FPH1(X1)、FPH2(X1)、FPH3(X1)
十字	75mm	PH2(X3)
套筒黑磷化双白圈	48mm	H8M
带珠接杆	65mm	Q1/4、Q3/8
带珠接杆	72mm	Q1/2
不锈钢分体接杆	60mm	H1/4

42 PCS **SGS6342P-3**
Combination set



规格	长度	数量
十字	25mm	PH0(X1)、PH1(X1)、PH2(X1)、PH3(X1)
一字		SL3.0(X1)、SL4.0(X1)、SL5.0(X1)、SL6.0(X1)
梅花带孔		TT8(X1)、TT9(X1)、TT10(X1)、TT15(X1)、TT20(X1)、TT25(X1)、TT27(X1)、TT30(X1)、TT40(X1)
一字		SL3(X1)、SL4(X1)、SL5(X1)
内六角	50mm	H3.0(X1)、H4.0(X1)、H5.0(X1)
十一字	65mm	FPH1(X1)、FPH2(X1)、FPH3(X1)
十字	75mm	PH2(X3)
套筒黑磷化双白圈	48mm	H8M
带珠接杆	65mm	Q1/4、Q3/8
带珠接杆	72mm	Q1/2
不锈钢分体接杆	60mm	H1/4
十字配磁环	65mm	PH2(X1)、63001(X1)

52 PCS **SGS6352P**
Combination set



规格	长度	数量
十字	25mm	PH1(X1)、PH2(X2)、PH3(X1)
梅花不带孔		T9(X1)、T10(X1)、T15(X1)、T20(X1)、T25(X1)、T27(X1)、T30(X1)、T40(X1)
梅花带孔		TT9(X1)、TT10(X1)、TT15(X1)、TT20(X1)、TT25(X1)、TT27(X1)、TT30(X1)、TT40(X1)
内六角		H1.5(X1)、H2.0(X1)、H2.5(X1)、H3.0(X1)、H4.0(X1)、H5.0(X1)、H6.0(X1)、H1/4(X1)
米字		PZ1(X1)、PZ2(X2)、PZ3(X1)
方形		SQ1(X1)、SQ2(X1)、SQ3(X1)、SQ4(X1)
一字		SL3(X1)、SL4(X1)、SL5(X1)、SL6(X1)
十字		PH1(X1)、PH2(X1)、PH3(X1)
方形		SQ1(X1)、SQ2(X1)、SQ3(X1)
米字		PZ1(X1)、PZ2(X1)、PZ3(X1)
套筒黑磷化双白圈	48mm	H6M、H8M
不锈钢分体接杆	60mm	H1/4

我们制造高标准批头，
种类全面，满足所有工业及手工业领域的需求。

We make high standard bits,
A comprehensive range to meet the needs of all industrial and handicraft industries.

■ 多功能组合套装 (S2材料、种类齐全) / Multi functional combination set (S2 material, complete variety)

规格	长度	数量
十字	25mm	PH1(X1)、PH2(X2)、PH3(X1)
米字		PZ1(X1)、PZ2(X2)、PZ3(X1)
梅花带孔		T8(X1)、T9(X1)、T10(X1)、T15(X1)、T20(X1)、T25(X1)、T30(X1)、T40(X1)
梅花不带孔		TT8(X1)、TT9(X1)、TT10(X1)、TT15(X1)、TT20(X1)、TT25(X1)、TT30(X1)、TT40(X1)
方形	75mm	SQ2(X4)
一字		SL3(X1)、SL4(X1)、SL5(X1)、SL6(X1)
梅花带孔		TT15(X1)、TT20(X1)、TT25(X1)
十字		PH2(X1)
米字	65mm、85mm	PZ2(X1)
PH2PH2-GA		65mmPH2PH2-GA (X1)、85mmPH2PH2-GA (X1)
不锈钢分体接杆		H1/4
套筒黑磷化双白圈		H6M、H8M、H10M
快脱黑杆(长红色)	72mm	KS-10072

规格	长度	数量
十字	25mm	PH2(X8)
一字		SL4(X2)、SL5(X2)
梅花不带孔		T30(X2)
内六角		H4.0(X2)
米字	50mm	PZ1(X3)、PZ2(X3)、PZ3(X1)
方形		SQ2(X2)
内六角		H5.0(X2)
一字		SL5(X2)
十字	75mm	PH2(X2)
十字	100mm	PH2(X3)
快脱黑杆(黑色)	60mm	KS-10060
不锈钢分体接杆	60mm	H1/4

规格	长度	数量
十字	25mm	PH2(X3)
内六角		H5.0(X3)
一字		SL5.0(X2)
十字	50mm	PH(X6)
十字	65mm	PH2(X6)
十字	100mm	PH2(X5)
不锈钢分体接杆	60mm	H1/4

规格	长度	数量
十字	25mm	PH1(X3)、PH2(X2)、PH3(X1)
米字		PZ2(X1)
内六角		H1.5(X1)、H2.0(X1)、H2.5(X1)、H3.0(X2)、H4.0(X2)、H5.0(X1)、H6.0(X1)、H1/4(X1)
梅花带孔		TT8(X1)、TT9(X1)、TT10(X1)、TT15(X1)、TT20(X1)、TT25(X1)、TT30(X1)、TT40(X1)
梅花不带孔	60mm	T10(X1)、T15(X1)、T20(X1)、T25(X1)、T30(X1)、T40(X1)
快脱黑杆(红色)		KS-10060

规格	长度	数量
十字	25mm	PH1(X1)、PH2(X2)、PH3(X1)
米字		PZ1(X1)、PZ2(X2)、PZ3(X1)
一字		SL3(X1)、SL4(X1)、SL5(X1)、SL6(X1)
梅花带孔		TT10(X1)、TT15(X1)、TT20(X1)、TT25(X1)、TT27(X1)、TT30(X1)、TT40(X1)
梅花不带孔	60mm	T10(X1)、T15(X1)、T20(X1)、T25(X1)、T27(X1)、T30(X1)、T40(X1)
内六角		H3.0(X1)、H4.0(X1)、H5.0(X1)、H6.0(X1)、H1/4(X1)
快脱黑杆(蓝色)	60mm	KS-10060

44 PCS **SGS6344P**
Combination set



34 PCS **SGS6334P**
Combination set



26 PCS **SGS6326P**
Combination set



32 PCS **SGS6332P-1**
Combination set



32 PCS **SGS6332P-2**
Combination set



SGS® 全新子品牌

科索 KESUO

系列 SERIES

更适用于木工类家具安装
家用电器、装修、玻璃幕墙等

Suitable for wood working furniture installation,
household appliances, decoration and so on.



科索系列包装
10支/盒；

磁力 Magnetic Force



磁性

超强的磁性使螺丝牢牢的吸附住螺丝, 大幅提高工作效率。

Magnetism

The super magnetism makes the screw firmly absorb. Hold the screws to greatly improve the working efficiency.



32N.M.

扭力Torque Force



TORSION

Torsion 部位

拧动螺丝的时候, 螺丝冲击螺丝刀的冲击反作用力由扭力部位吸收, 可以有效的防止刀头损坏, 有效延长批头使用寿命。

Torsion part

When turning the screw, the impact reaction force of the screw impacting the screwdriver is absorbed by the torque part, which can effectively prevent damage to the blade and prolong the service life of the screwdriver

S2

62±1° 硬度HRC

高硬度材料

S2

采用进口S2材料, 整体经特殊热处理加工超高扭力输出

High hardness material

Imported S2 material used, through special heat treatment processing ultra-high torque output



— 仿冒必究 —



环保标识

产品严格遵循限制使用Pb(铅)、Cd(镉)、Hg(水银)、六价铬、PBB(多溴联苯)、PBDE(二溴联苯醚)的相关法律法规。



强磁标识

订货号/Item No	品名/Product Name	支/PCS	支/PCS	支/PCS
SGS6365 PH2PH2-EA	双头十字批头65mm	10	200	2000
SGS63100 PH2PH2-EA	双头十字批头100mm	10	100	1000
SGS6365 PH2PH2-C	双头十字批头65mm	10	200	2000
SGS63100 PH2PH2-C	双头十字批头100mm	10	100	1000

PH2头部尺寸选择

注:手工测量存在一定误差,仅供参考

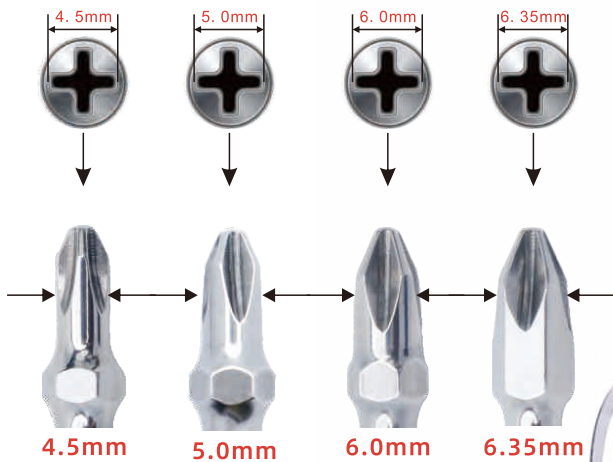

10 screw bits with 1 magnetic ring

10支批头
1个磁圈

包装盒采用UV印刷
The packaging box is UV printed

高硬度材料

S2 采用进口S2材料,整体经特殊热处理加工超高扭力输出, HRC61°±1

High hardness material

Imported S2 material used, through special heat treatment processing ultra-high torque output.

磁性

超强的磁性使螺丝牢牢的吸附住螺丝,大幅提高工作效率

Magnetism

the super magnetism makes the screw bits firmly grip the screws, Greatly improve work efficiency

LOGO 塑料套管

套管logo可定制

Plastic sleeve

The casing logo can be customized



表面精抛处理

有效保持批头头型的精准度, 消除热处理后的内应力从而大大提升批头的使用寿命。

Surface finishing

Effectively maintain the accuracy of the screw bit head, eliminate the internal stress after heat treatment, thus greatly improving the life of the screw bits

Torsion 部位



拧动螺丝的时候, 螺丝冲击螺丝刀的冲击反作用力由扭力部位吸收, 可以有效的防止刀头损坏, 有效延长批头使用寿命。

Torsion part

When turn the screw, the impact reaction force of the screw on the screw bits are absorbed by the torsion part, which can effectively prevent the damage of the screw bits and effectively longer the life



宝得彩色展示盒适合放在收银台
Baode color display box is suitable for putting in the cash register



环保标识

产品严格遵循限制使用Pb(铅)、Cd(镉)、Hg(水银)、六价铬、PBB(多溴联苯)、PBDE(二溴联苯醚)的相关法律法规。

订货号/Item No	品名/Product Name	支/PCS	支/PCS	支/PCS
SGS6365 PH2PH2-DA(4.5)	宝得系列 65mm	10	100	1000
SGS63100 PH2PH2-DA(4.5)	宝得系列 100mm	10	100	1000
SGS6365 PH2PH2-DA(5.0)	宝得系列 65mm	10	100	1000
SGS63100 PH2PH2-DA(5.0)	宝得系列 100mm	10	100	1000
SGS6365 PH2PH2-DA(6.0)	宝得系列 65mm	10	100	1000
SGS63100 PH2PH2-DA(6.0)	宝得系列 100mm	10	100	1000
SGS6365 PH2PH2-DA(6.35)	宝得系列 65mm	10	100	1000
SGS63100 PH2PH2-DA(6.35)	宝得系列 100mm	10	100	1000

DOUBLE HEAD BITS

双头批头

工业级双头螺丝批头

Industrial double head
screw bits





我们制造高标准批头，
种类全面，满足所有工业及手工业领域的需求。

We make high standard bits,
A comprehensive range to meet the needs of all industrial and handicraft fields

■ 双头磁环定位批头/Double head magnetic ring positioning screw bits

对边:6.35MM

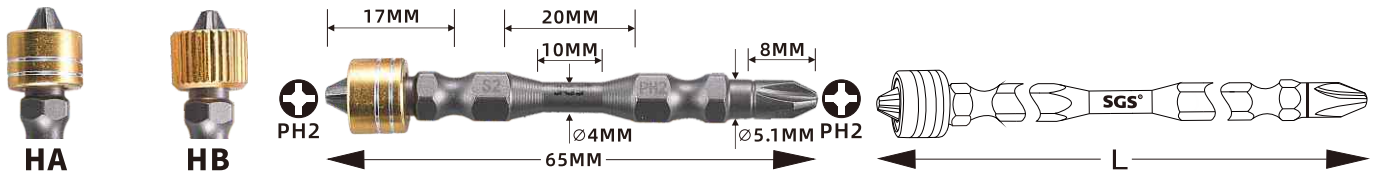

双头H款



- 高端进口S2材质
- 特殊热处理工艺, HRC61±1度
- 表面本色喷砂处理(可做其他表面处理:精抛, 黑磷化等)
- 磁圈可拆卸, 两头均可使用
- 用途: 增强磁性及定位

- .High-end imported S2 material
- .Special heat treatment process, HRC61±1 degree
- .Sandblasted surface (Others are available: Fine polishing, black phosphating, etc.)
- .The magnetic ring is detachable, both ends can be used
- .Usage: Enhance the magnetism and positioning

订货号/Item No	品名/Product Name	支/PCS	支/PCS	支/PCS
SGS6365 PH2PH2-HA	双头磁圈定位批头65mm	10	200	1000
SGS63100 PH2PH2-HA	双头磁圈定位批头100mm	10	100	1000
SGS6365 PH2PH2-HB	双头磁圈定位批头65mm	10	200	1000
SGS63100 PH2PH2-HB	双头磁圈定位批头100mm	10	100	1000

■ 6.35系列双头冲击批 / 1/4" Hexagon driver series double headed double-head impact screw bits

对边:6.35MM

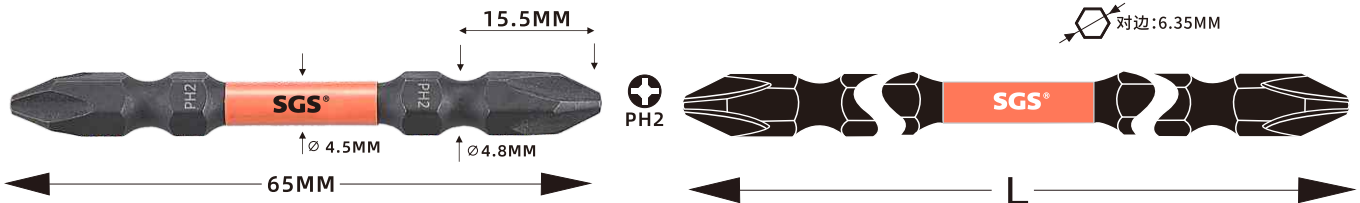

双头冲击批



- 高端进口S2材质
- 特殊热处理工艺, HRC61±1度
- 表面黑磷化处理+PE管
- 规格齐全
- 可定制其他颜色, 长度, 杆径, 头型及造型

- .High-end imported S2 material
- .Special heat treatment process, HRC61±1 degree
- .Surface black phosphating treatment+PE pipe
- .Complete specifications
- .Other colors, lengths, rod diameters, head shapes and shapes can be customized

订货号/Item No	品名/Product Name	支/PCS	支/PCS	支/PCS
SGS6365 PH2PH2-GA	双头十字冲击批头65mm	10	200	2000
SGS6385 PH2PH2-GA	双头十字冲击批头85mm	10	100	1000
SGS63110 PH2PH2-GA	双头十字冲击批头110mm	10	100	1000
SGS63150 PH2PH2-GA	双头十字冲击批头150mm	10	100	1000

我们制造高标准批头，
种类全面，满足所有工业及手工业领域的需求。

We make high standard bits,
A comprehensive range to meet the needs of all industrial and handicraft fields



6.35mm系列双头十字螺丝批头 (S2材料, 高寿命) 1/4" Hexagon Driver Phillips Double Ended Power Bits

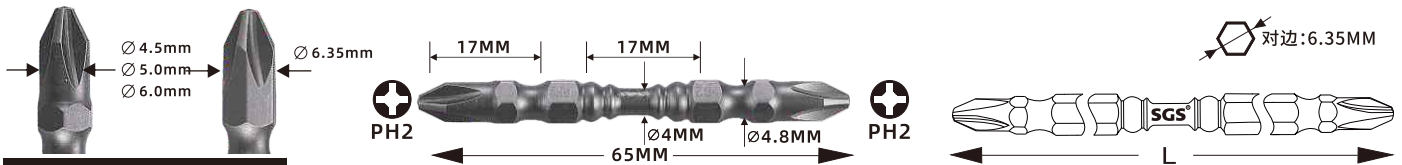

S款



- 高端进口S2材质
- 特殊热处理工艺, HRC61±1度
- 表面处理: 本色喷砂/珍珠镍/黑磷化/抛光
注: 可定制其他表面处理

- .High-end imported S2 material
- .Special heat treatment process, HRC61±1 degree
- .Surface treatment: Sandblasted/Pearl Nickel /Fine polishing/black phosphating

订货号/Item No	品名/Product Name	支/PCS	支/PCS	支/PCS
SGS6365 PH1PH1-S(5.0)	高扭力S款65 mm	10	200	2000
SGS6365 PH2PH2-S(4.5)	高扭力S款65 mm	10	200	2000
SGS6365 PH2PH2-S(5.0)	高扭力S款65 mm	10	200	2000
SGS6365 PH2PH2-S(6.0)	高扭力S款65 mm	10	200	2000
SGS6365 PH2PH2-S(6.35)	高扭力S款65 mm	10	200	2000
SGS6365 PH3PH3-S(6.0)	高扭力S款65 mm	10	200	2000
SGS6365 PH3PH3-S(6.35)	高扭力S款65 mm	10	200	2000
SGS63100 PH1PH1-S(6.35)	高扭力S款100mm	10	100	1000
SGS63100 PH2PH2-S(4.5)	高扭力S款100mm	10	100	1000
SGS63100 PH2PH2-S(5.0)	高扭力S款100mm	10	100	1000
SGS63100 PH2PH2-S(6.0)	高扭力S款100mm	10	100	1000
SGS63100 PH2PH2-S(6.35)	高扭力S款100mm	10	100	1000
SGS63110 PH1PH1-S(6.35)	高扭力S款110mm	10	100	1000
SGS63110 PH2PH2-S(4.5)	高扭力S款110mm	10	100	1000
SGS63110 PH2PH2-S(5.0)	高扭力S款110mm	10	100	1000
SGS63110 PH2PH2-S(6.0)	高扭力S款110mm	10	100	1000
SGS63110 PH2PH2-S(6.35)	高扭力S款110mm	10	100	1000
SGS63110 PH3PH3-S(6.35)	高扭力S款110mm	10	100	1000
SGS63150 PH2PH2-S(5.0)	高扭力S款150mm	10	100	1000
SGS63150 PH2PH2-S(6.0)	高扭力S款150mm	10	100	1000
SGS63150 PH2PH2-S(6.35)	高扭力S款150mm	10	100	1000
SGS63150 PH3PH3-S(6.35)	高扭力S款150mm	10	100	1000

**我们制造高标准批头，
种类全面，满足所有工业及手工业领域的需求。**

We make high standard bits,
A comprehensive range to meet the needs of all industrial and handicraft fields



■ 6.35mm系列双头十字螺丝批头 (S2材料) 1/4"Hexagon Driver Phillips Double Ended Power Bits



C 款



- 高端进口S2材质
- 特殊热处理工艺, HRC61±1度
- 表面处理: 本色喷砂/珍珠镍/黑磷化/抛光
注: 可定制其他表面处理

- .High-end imported S2 material
- .Special heat treatment process, HRC61±1 degree
- .Surface treatment: Sandblasted/Pearl Nickel/Fine polishing/black phosphating

订货号/Item No	品名/Product Name	支/PCS	支/PCS	支/PCS
SGS6350 PH1PH1-C(6.0)	常规C款50mm	10	200	2000
SGS6350 PH1PH1-C(6.35)	常规C款50mm	10	200	2000
SGS6350 PH2PH2-C(6.0)	常规C款50mm	10	200	2000
SGS6350 PH2PH2-C(6.35)	常规C款50mm	10	200	2000
SGS6350 PH3PH3-C(6.35)	常规C款50mm	10	200	2000
SGS6365 PH1PH1-C(6.35)	常规C款65mm	10	200	2000
SGS6365 PH2PH2-C(4.5)	常规C款65mm	10	200	2000
SGS6365 PH2PH2-C(5.0)	常规C款65mm	10	200	2000
SGS6365 PH2PH2-C(6.0)	常规C款65mm	10	200	2000
SGS6365 PH2PH2-C(6.35)	常规C款65mm	10	200	2000
SGS6365 PH3PH3-C(6.35)	常规C款65mm	10	200	2000
SGS6375 PH2PH2-C(6.35)	常规C款75mm	10	100	1000
SGS6375 PH3PH3-C(6.35)	常规C款75mm	10	100	1000
SGS6380 PH2PH2-C(6.35)	常规C款80mm	10	100	1000
SGS63100 PH1PH1-C(6.35)	常规C款100mm	10	100	1000
SGS63100 PH2PH2-C(4.5)	常规C款100mm	10	100	1000
SGS63100 PH2PH2-C(5.0)	常规C款100mm	10	100	1000
SGS63100 PH2PH2-C(6.0)	常规C款100mm	10	100	1000
SGS63100 PH2PH2-C(6.35)	常规C款100mm	10	100	1000
SGS63100 PH3PH3-C(6.35)	常规C款100mm	10	100	1000
SGS63110 PH1PH1-C(6.35)	常规C款110mm	10	100	1000
SGS63110 PH2PH2-C(5.0)	常规C款110mm	10	100	1000
SGS63110 PH2PH2-C(6.0)	常规C款110mm	10	100	1000
SGS63110 PH2PH2-C(6.35)	常规C款110mm	10	100	1000
SGS63110 PH3PH3-C(6.35)	常规C款110mm	10	100	1000
SGS63120 PH2PH2-C(6.35)	常规C款120mm	10	100	1000
SGS63150 PH1PH1-C(6.35)	常规C款150mm	10	100	1000
SGS63150 PH2PH2-C(5.0)	常规C款150mm	10	100	1000
SGS63150 PH2PH2-C(6.0)	常规C款150mm	10	100	1000
SGS63150 PH2PH2-C(6.35)	常规C款150mm	10	100	1000
SGS63150 PH3PH3-C(6.35)	常规C款150mm	10	100	1000
SGS63200 PH2PH2-C(6.0)	常规C款200mm	10	100	1000
SGS63200 PH2PH2-C(6.35)	常规C款200mm	10	100	1000
SGS63200 PH3PH3-C(6.35)	常规C款200mm	10	100	1000
SGS63250 PH3PH3-C(6.0)	常规C款250mm	5	50	500
SGS63250 PH2PH2-C(6.35)	常规C款250mm	5	50	500
SGS63300 PH3PH3-C(6.0)	常规C款300mm	5	50	500
SGS63300 PH2PH2-C(6.35)	常规C款300mm	5	50	500
SGS63400 PH2PH2-C(6.0)	常规C款400mm	5	50	500
SGS63400 PH2PH2-C(6.35)	常规C款400mm	5	50	500
SGS63500 PH2PH2-C(6.35)	常规C款500mm	5	50	500
SGS63600 PH2PH2-C(6.35)	常规C款600mm	5	50	500

我们制造高标准批头，
种类全面，满足所有工业及手工业领域的需求。

We make high standard bits,
A comprehensive range to meet the needs of all industrial and handicraft fields



6.35mm系列双头十字螺丝批头(S2材料) 1/4"Hexagon Driver Phillips Double Ended Power Bits

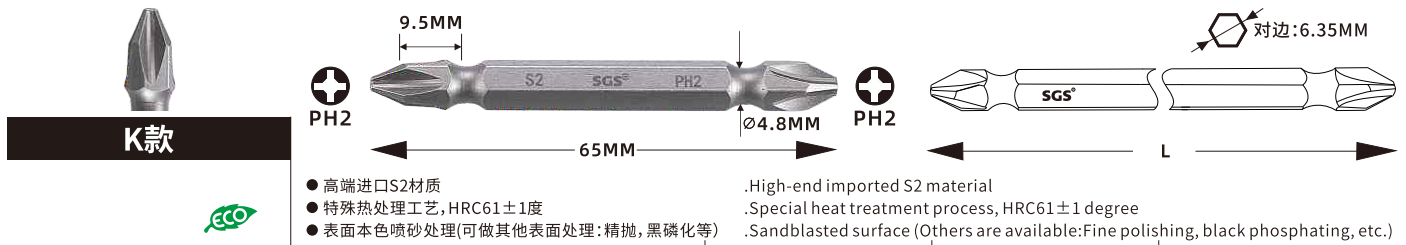

订货号/Item No	品名/Product Name	支/PCS	支/PCS	支/PCS
SGS6365 PH2PH2-K	短槽k款65mm	10	200	2000
SGS6365 PH3PH3-K	短槽k款65mm	10	200	2000
SGS6375 PH1PH1-K	短槽k款75mm	10	100	1000
SGS6375 PH2PH2-K	短槽k款75mm	10	100	1000
SGS6375 PH3PH3-K	短槽k款75mm	10	100	1000
SGS63100 PH2PH2-K	短槽k款100mm	10	100	1000
SGS63100 PH3PH3-K	短槽k款100mm	10	100	1000
SGS63110 PH1PH1-K	短槽k款110mm	10	100	1000
SGS63110 PH2PH2-K	短槽k款110mm	10	100	1000
SGS63110 PH3PH3-K	短槽k款110mm	10	100	1000
SGS63150 PH2PH2-K	短槽k款150mm	10	100	1000
SGS63200 PH2PH2-K	短槽k款200mm	10	100	1000
SGS63200 PH3PH3-K	短槽k款200mm	10	100	1000
SGS63300 PH2PH2-K	短槽k款300mm	5	50	500

5mm双头十字螺丝批头(S2材料) 1/5"Hexagon Driver Phillips Double Ended Power Bits

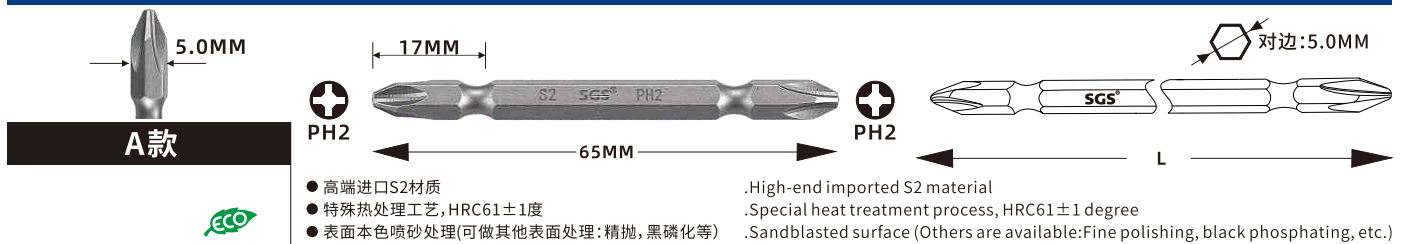

订货号/Item No	品名/Product Name	支/PCS	支/PCS	支/PCS
SGS5065 PH2PH2-A	细杆A款65mm	10	200	2000
SGS5075 PH2PH2-A	细杆A款75mm	10	100	1000
SGS50100 PH2PH2-A	细杆A款100mm	10	100	1000
SGS50150 PH2PH2-A	细杆A款150mm	10	100	1000
SGS50200 PH2PH2-A	细杆A款200mm	10	100	1000
SGS50300 PH2PH2-A	细杆A款300mm	5	50	500

我们制造高标准批头，
种类全面，满足所有工业及手工业领域的需求。

We make high standard bits,
A comprehensive range to meet the needs of all industrial and handicraft fields



6.35mm系列双头十字一字螺丝批头(S2材料) 1/4"Hexagon Driver Phillips And Slotted Double Ended Power Bits

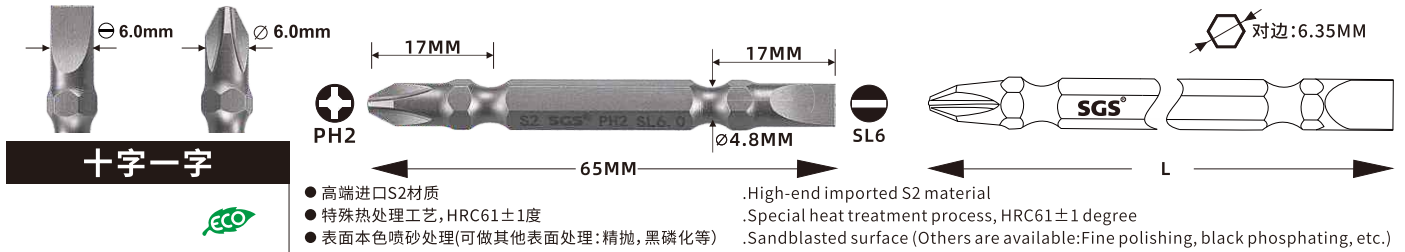

订货号/Item No	品名/Product Name	支/PCS	支/PCS	支/PCS
SGS6338 PH2SL6	常规十字一字38mm	10	200	2000
SGS6365 PH2SL6.0-C(6.0)	常规十字一字65mm	10	200	2000
SGS63100 PH2SL6.0-C(6.0)	常规十字一字100mm	10	100	1000
SGS63110 PH2SL6.0-C(6.0)	常规十字一字110mm	10	100	1000
SGS63110 PH2SL6.0-C(6.0)	常规十字一字110mm	10	100	1000
SGS63150 PH2SL6.0-C(6.0)	常规十字一字150mm	10	100	1000
SGS63200 PH2SL6.0-C(6.0)	常规十字一字200mm	10	100	1000

6.35mm系列双头梅花螺丝批头(S2材料) 1/4" Hexagon driver series double ended Torx screw bits(S2 material)



订货号/Item No	品名/Product Name	支/PCS	支/PCS	支/PCS
SGS6365 T15T15	双头梅花65mm	10	200	2000
SGS6365 T20T20	双头梅花65mm	10	200	2000
SGS6365 T25T25	双头梅花65mm	10	200	2000
SGS6365 T30T30	双头梅花65mm	10	200	2000
SGS6365 T40T40	双头梅花65mm	10	200	2000
SGS63100 T15T15	双头梅花100mm	10	100	1000
SGS63100 T20T20	双头梅花100mm	10	100	1000
SGS63100 T25T25	双头梅花100mm	10	100	1000
SGS63100 T30T30	双头梅花100mm	10	100	1000
SGS63100 T40T40	双头梅花100mm	10	100	1000

6.35mm系列双头内六角螺丝批头(S2材料) 1/4" Hexagon driver series double ended hex screw bits(S2 material)



订货号/Item No	品名/Product Name	支/PCS	支/PCS	支/PCS
SGS6365 H3.0H3.0	双头内六角65mm	10	200	2000
SGS6365 H4.0H4.0	双头内六角65mm	10	200	2000
SGS6365 H5.0H5.0	双头内六角65mm	10	200	2000
SGS6365 H6.0H6.0	双头内六角65mm	10	200	2000
SGS63100 H3.0H3.0	双头内六角100mm	10	100	1000
SGS63100 H4.0H4.0	双头内六角100mm	10	100	1000
SGS63100 H5.0H5.0	双头内六角100mm	10	100	1000
SGS63100 H6.0H6.0	双头内六角100mm	10	100	1000

单头冲击批头— 强劲动力，精准打击

Single-head impact driver - powerful,
precise strikes

Single head impact bits

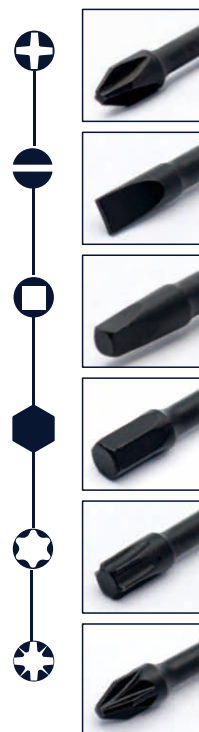

我们制造高标准批头，
种类全面，满足所有工业及手工业领域的需求。

We make high standard bits,
A comprehensive range to meet the needs of all industrial and handicraft fields



■ 6.35mm系列单头十字冲击批头(S2材料) 1/4" Hexagon driver series Phillips impact screw bits(S2 material)

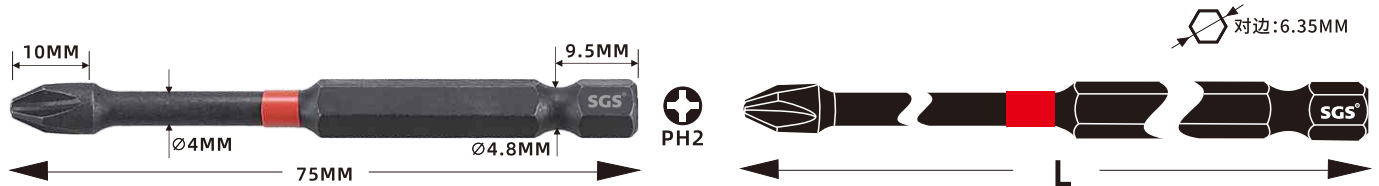

单头十字冲击批



- 高端进口S2材质
- 特殊热处理工艺, HRC61±1度
- 表面黑磷化处理+PE管
- 规格齐全
- 可定制其他颜色, 长度, 杆径, 头型及造型

- .High-end imported S2 material
- .Special heat treatment process, HRC61±1 degree
- .Surface black phosphating treatment+PE pipe
- .Complete specifications
- .Other colors,lengths,rod diameters, head shapes and shapes can be customized

订货号/Item No	品名/Product Name	支/PCS	支/PCS	支/PCS
SGS6325 PH0-IB	十字冲击批系列25mm	20	400	4000
SGS6325 PH1-IB	十字冲击批系列25mm	20	400	4000
SGS6325 PH2-IB	十字冲击批系列25mm	20	400	4000
SGS6325 PH3-IB	十字冲击批系列25mm	20	400	4000
SGS6350 PH1-IB	十字冲击批系列50mm	10	200	2000
SGS6350 PH2-IB	十字冲击批系列50mm	10	200	2000
SGS6350 PH3-IB	十字冲击批系列50mm	10	200	2000
SGS6365 PH1-IB	十字冲击批系列65mm	10	200	2000
SGS6365 PH2-IB	十字冲击批系列65mm	10	200	2000
SGS6365 PH3-IB	十字冲击批系列65mm	10	200	2000
SGS6370 PH2-IB	十字冲击批系列70mm	10	100	1000
SGS6375 PH1-IB	十字冲击批系列75mm	10	100	1000
SGS6375 PH2-IB	十字冲击批系列75mm	10	100	1000
SGS6375 PH3-IB	十字冲击批系列75mm	10	100	1000
SGS6390 PH1-IB	十字冲击批系列90mm	10	100	1000
SGS6390 PH2-IB	十字冲击批系列90mm	10	100	1000
SGS6390 PH3-IB	十字冲击批系列90mm	10	100	1000
SGS63100 PH1-IB	十字冲击批系列100mm	10	100	1000
SGS63100 PH2-IB	十字冲击批系列100mm	10	100	1000
SGS63100 PH3-IB	十字冲击批系列100mm	10	100	1000
SGS63150 PH1-IB	十字冲击批系列150mm	10	100	1000
SGS63150 PH2-IB	十字冲击批系列150mm	10	100	1000
SGS63150 PH3-IB	十字冲击批系列150mm	10	100	1000

我们制造高标准批头，
种类全面，满足所有工业及手工业领域的需求。

We make high standard bits,
A comprehensive range to meet the needs of all industrial and handicraft fields



6.35mm系列单头米字冲击批头(S2材料) 1/4" Hexagon driver series Pozidriv impact screw bits(S2 material)

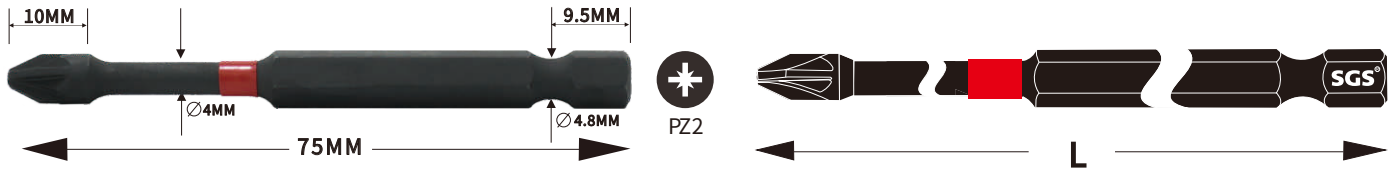

单头米字冲击批



- 高端进口S2材质
- 特殊热处理工艺, HRC61±1度
- 表面黑磷化处理+PE管
- 规格齐全
- 可定制其他颜色, 长度, 杆径, 头型及造型

- .High-end imported S2 material
- .Special heat treatment process, HRC61±1 degree
- .Surface black phosphating treatment+PE pipe
- .Complete specifications
- .Other colors,lengths,rod diameters, head shapes and shapes can be customized

订货号/Item No	品名/Product Name	支/PCS	支/PCS	支/PCS
SGS6325 PZ1-IB	米字冲击批系列25mm	20	400	4000
SGS6325 PZ2-IB	米字冲击批系列25mm	20	400	4000
SGS6325 PZ3-IB	米字冲击批系列25mm	20	400	4000
SGS6350 PZ1-IB	米字冲击批系列50mm	10	200	2000
SGS6350 PZ2-IB	米字冲击批系列50mm	10	200	2000
SGS6350 PZ3-IB	米字冲击批系列50mm	10	200	2000
SGS6365 PZ1-IB	米字冲击批系列65mm	10	200	2000
SGS6365 PZ2-IB	米字冲击批系列65mm	10	200	2000
SGS6365 PZ3-IB	米字冲击批系列65mm	10	200	2000
SGS6370 PZ2-IB	米字冲击批系列70mm	10	100	1000
SGS6375 PZ1-IB	米字冲击批系列75mm	10	100	1000
SGS6375 PZ2-IB	米字冲击批系列75mm	10	100	1000
SGS6375 PZ3-IB	米字冲击批系列75mm	10	100	1000
SGS6390 PZ1-IB	米字冲击批系列90mm	10	100	1000
SGS6390 PZ2-IB	米字冲击批系列90mm	10	100	1000
SGS6390 PZ3-IB	米字冲击批系列90mm	10	100	1000
SGS63100 PZ1-IB	米字冲击批系列100mm	10	100	1000
SGS63100 PZ2-IB	米字冲击批系列100mm	10	100	1000
SGS63100 PZ3-IB	米字冲击批系列100mm	10	100	1000
SGS63150 PZ1-IB	米字冲击批系列150mm	10	100	1000
SGS63150 PZ2-IB	米字冲击批系列150mm	10	100	1000
SGS63150 PZ3-IB	米字冲击批系列150mm	10	100	1000



**我们制造高标准批头，
种类全面，满足所有工业及手工业领域的需求。**

We make high standard bits,
A comprehensive range to meet the needs of all industrial and handicraft fields

■ 6.35mm系列梅花不带孔冲击批头(S2材料) 1/4" Hexagon driver series Torx impact screw bits(S2 material)

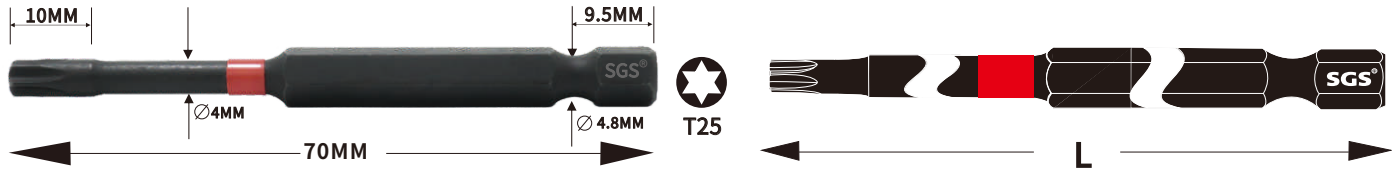

梅花不带孔冲击批



- 高端进口S2材质
- 特殊热处理工艺, HRC61±1度
- 表面黑磷化处理+PE管
- 规格齐全
- 可定制其他颜色, 长度, 杆径, 头型及造型

- .High-end imported S2 material
- .Special heat treatment process, HRC61±1 degree
- .Surface black phosphating treatment+PE pipe
- .Complete specifications
- .Other colors,lengths,rod diameters, head shapes and shapes can be customized

订货号/Item No	品名 Product Name	📦	📦	📦	订货号/Item No	品名 Product Name	📦	📦	📦
SGS6325 T7-IB	不带孔梅花冲击批系列25mm	20	400	4000	SGS6370 T9-IB	不带孔梅花冲击批系列70mm	10	100	1000
SGS6325 T8-IB	不带孔梅花冲击批系列25mm	20	400	4000	SGS6370 T10-IB	不带孔梅花冲击批系列70mm	10	100	1000
SGS6325 T9-IB	不带孔梅花冲击批系列25mm	20	400	4000	SGS6370 T15-IB	不带孔梅花冲击批系列70mm	10	100	1000
SGS6325 T10-IB	不带孔梅花冲击批系列25mm	20	400	4000	SGS6370 T20-IB	不带孔梅花冲击批系列70mm	10	100	1000
SGS6325 T15-IB	不带孔梅花冲击批系列25mm	20	400	4000	SGS6370 T25-IB	不带孔梅花冲击批系列70mm	10	100	1000
SGS6325 T20-IB	不带孔梅花冲击批系列25mm	20	400	4000	SGS6370 T27-IB	不带孔梅花冲击批系列70mm	10	100	1000
SGS6325 T25-IB	不带孔梅花冲击批系列25mm	20	400	4000	SGS6370 T30-IB	不带孔梅花冲击批系列70mm	10	100	1000
SGS6325 T27-IB	不带孔梅花冲击批系列25mm	20	400	4000	SGS63100 T8-IB	不带孔梅花冲击批系列100mm	10	100	1000
SGS6325 T30-IB	不带孔梅花冲击批系列25mm	20	400	4000	SGS63100 T9-IB	不带孔梅花冲击批系列100mm	10	100	1000
SGS6350 T7-IB	不带孔梅花冲击批系列50mm	10	200	2000	SGS63100 T10-IB	不带孔梅花冲击批系列100mm	10	100	1000
SGS6350 T8-IB	不带孔梅花冲击批系列50mm	10	200	2000	SGS63100 T15-IB	不带孔梅花冲击批系列100mm	10	100	1000
SGS6350 T9-IB	不带孔梅花冲击批系列50mm	10	200	2000	SGS63100 T20-IB	不带孔梅花冲击批系列100mm	10	100	1000
SGS6350 T10-IB	不带孔梅花冲击批系列50mm	10	200	2000	SGS63100 T25-IB	不带孔梅花冲击批系列100mm	10	100	1000
SGS6350 T15-IB	不带孔梅花冲击批系列50mm	10	200	2000	SGS63100 T27-IB	不带孔梅花冲击批系列100mm	10	100	1000
SGS6350 T20-IB	不带孔梅花冲击批系列50mm	10	200	2000	SGS63100 T30-IB	不带孔梅花冲击批系列100mm	10	100	1000
SGS6350 T25-IB	不带孔梅花冲击批系列50mm	10	200	2000	SGS63150 T15-IB	不带孔梅花冲击批系列150mm	10	100	1000
SGS6350 T27-IB	不带孔梅花冲击批系列50mm	10	200	2000	SGS63150 T25-IB	不带孔梅花冲击批系列150mm	10	100	1000
SGS6350 T30-IB	不带孔梅花冲击批系列50mm	10	200	2000	SGS63150 T20-IB	不带孔梅花冲击批系列150mm	10	100	1000
SGS6370 T7-IB	不带孔梅花冲击批系列70mm	10	100	1000	SGS63150 T30-IB	不带孔梅花冲击批系列150mm	10	100	1000
SGS6370 T8-IB	不带孔梅花冲击批系列70mm	10	100	1000	SGS63150 T40-IB	不带孔梅花冲击批系列150mm	10	100	1000



**我们制造高标准批头，
种类全面，满足所有工业及手工业领域的需求。**

We make high standard bits,
A comprehensive range to meet the needs of all industrial and handicraft fields

■ 6.35mm系列梅花带孔冲击批头(S2材料) 1/4" Hexagon driver series tamper proof Torx impact screw bits(S2 material)

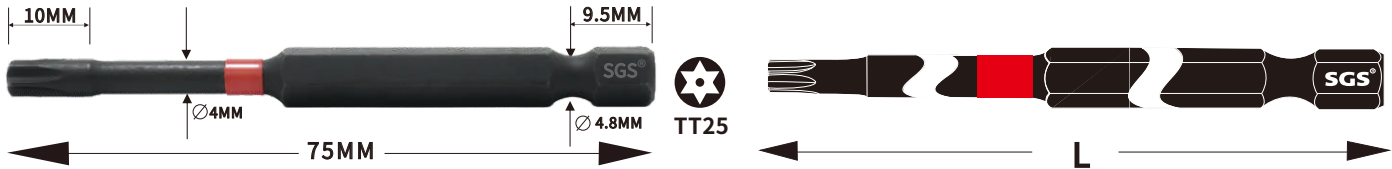

梅花带孔冲击批

- 高端进口S2材质
- 特殊热处理工艺, HRC61±1度
- 表面黑磷化处理+PE管
- 规格齐全
- 可定制其他颜色, 长度, 杆径, 头型及造型

- .High-end imported S2 material
- .Special heat treatment process, HRC61±1 degree
- .Surface black phosphating treatment+PE pipe
- .Complete specifications
- .Other colors,lengths,rod diameters, head shapes and shapes can be customized

订货号/Item No	品名 Product Name				订货号/Item No	品名 Product Name			
SGS6325 TT7-IB	带孔梅花冲击批系列25mm	20	400	4000	SGS6375 TT9-IB	带孔梅花冲击批系列75mm	10	100	1000
SGS6325 TT8-IB	带孔梅花冲击批系列25mm	20	400	4000	SGS6375 TT10-IB	带孔梅花冲击批系列75mm	10	100	1000
SGS6325 TT9-IB	带孔梅花冲击批系列25mm	20	400	4000	SGS6375 TT15-IB	带孔梅花冲击批系列75mm	10	100	1000
SGS6325 TT10-IB	带孔梅花冲击批系列25mm	20	400	4000	SGS6375 TT20-IB	带孔梅花冲击批系列75mm	10	100	1000
SGS6325 TT15-IB	带孔梅花冲击批系列25mm	20	400	4000	SGS6375 TT25-IB	带孔梅花冲击批系列75mm	10	100	1000
SGS6325 TT20-IB	带孔梅花冲击批系列25mm	20	400	4000	SGS6375 TT27-IB	带孔梅花冲击批系列75mm	10	100	1000
SGS6325 TT25-IB	带孔梅花冲击批系列25mm	20	400	4000	SGS6375 TT30-IB	带孔梅花冲击批系列75mm	10	100	1000
SGS6325 TT27-IB	带孔梅花冲击批系列25mm	20	400	4000	SGS6375 TT40-IB	带孔梅花冲击批系列75mm	10	100	1000
SGS6325 TT30-IB	带孔梅花冲击批系列25mm	20	400	4000	SGS63100 TT7-IB	带孔梅花冲击批系列100mm	10	100	1000
SGS6325 TT40-IB	带孔梅花冲击批系列25mm	20	400	4000	SGS63100 TT8-IB	带孔梅花冲击批系列100mm	10	100	1000
SGS6350 TT7-IB	带孔梅花冲击批系列50mm	10	200	2000	SGS63100 TT9-IB	带孔梅花冲击批系列100mm	10	100	1000
SGS6350 TT8-IB	带孔梅花冲击批系列50mm	10	200	2000	SGS63100 TT10-IB	带孔梅花冲击批系列100mm	10	100	1000
SGS6350 TT9-IB	带孔梅花冲击批系列50mm	10	200	2000	SGS63100 TT15-IB	带孔梅花冲击批系列100mm	10	100	1000
SGS6350 TT10-IB	带孔梅花冲击批系列50mm	10	200	2000	SGS63100 TT20-IB	带孔梅花冲击批系列100mm	10	100	1000
SGS6350 TT15-IB	带孔梅花冲击批系列50mm	10	200	2000	SGS63100 TT25-IB	带孔梅花冲击批系列100mm	10	100	1000
SGS6350 TT20-IB	带孔梅花冲击批系列50mm	10	200	2000	SGS63100 TT27-IB	带孔梅花冲击批系列100mm	10	100	1000
SGS6350 TT25-IB	带孔梅花冲击批系列50mm	10	200	2000	SGS63100 TT30-IB	带孔梅花冲击批系列100mm	10	100	1000
SGS6350 TT27-IB	带孔梅花冲击批系列50mm	10	200	2000	SGS63100 TT40-IB	带孔梅花冲击批系列100mm	10	100	1000
SGS6350 TT30-IB	带孔梅花冲击批系列50mm	10	200	2000	SGS63150 TT15-IB	带孔梅花冲击批系列150mm	10	100	1000
SGS6350 TT40-IB	带孔梅花冲击批系列50mm	10	200	2000	SGS63150 TT20-IB	带孔梅花冲击批系列150mm	10	100	1000
SGS6375 TT7-IB	带孔梅花冲击批系列75mm	10	100	1000	SGS63150 TT25-IB	带孔梅花冲击批系列150mm	10	100	1000
SGS6375 TT8-IB	带孔梅花冲击批系列75mm	10	100	1000	SGS63150 TT30-IB	带孔梅花冲击批系列150mm	10	100	1000



**我们制造高标准批头，
种类全面，满足所有工业及手工业领域的需求。**

We make high standard bits,
A comprehensive range to meet the needs of all industrial and handicraft fields

■ 6.35mm系列单头内六角冲击批头(S2材料) 1/4" Hexagon driver series Hex impact screw bits(S2 material)



对边:6.35MM

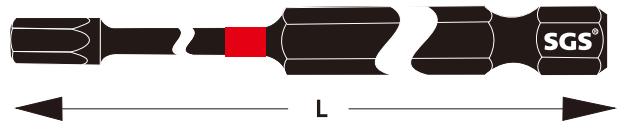

单头内六角冲击批



- 高端进口S2材质
- 特殊热处理工艺, HRC61±1度
- 表面黑磷化处理+PE管
- 规格齐全
- 可定制其他颜色, 长度, 杆径, 头型及造型

- .High-end imported S2 material
- .Special heat treatment process, HRC61±1 degree
- .Surface black phosphating treatment+PE pipe
- .Complete specifications
- .Other colors,lengths,rod diameters, head shapes and shapes can be customized

订货号/Item No	品名/Product Name	支/PCS	支/PCS	支/PCS
SGS6325 H1.5-IB	内六角冲击批头系列25mm	20	400	4000
SGS6325 H2.0-IB	内六角冲击批头系列25mm	20	400	4000
SGS6325 H2.5-IB	内六角冲击批头系列25mm	20	400	4000
SGS6325 H3.0-IB	内六角冲击批头系列25mm	20	400	4000
SGS6325 H4.0-IB	内六角冲击批头系列25mm	20	400	4000
SGS6325 H5.0-IB	内六角冲击批头系列25mm	20	400	4000
SGS6325 H6.0-IB	内六角冲击批头系列25mm	20	400	4000
SGS6325 H7.0-IB	内六角冲击批头系列25mm	20	400	4000
SGS6325 H8.0-IB	内六角冲击批头系列25mm	20	400	4000
SGS6350 H1.5-IB	内六角冲击批头系列50mm	10	200	2000
SGS6350 H2.0-IB	内六角冲击批头系列50mm	10	200	2000
SGS6350 H2.5-IB	内六角冲击批头系列50mm	10	200	2000
SGS6350 H3.0-IB	内六角冲击批头系列50mm	10	200	2000
SGS6350 H4.0-IB	内六角冲击批头系列50mm	10	200	2000
SGS6350 H5.0-IB	内六角冲击批头系列50mm	10	200	2000
SGS6350 H6.0-IB	内六角冲击批头系列50mm	10	200	2000
SGS6350 H7.0-IB	内六角冲击批头系列50mm	10	200	2000
SGS6350 H8.0-IB	内六角冲击批头系列50mm	10	200	2000
SGS6375 H1.5-IB	内六角冲击批头系列75mm	10	200	2000
SGS6375 H2.0-IB	内六角冲击批头系列75mm	10	200	2000
SGS6375 H2.5-IB	内六角冲击批头系列75mm	10	200	2000
SGS6375 H3.0-IB	内六角冲击批头系列75mm	10	200	2000
SGS6375 H4.0-IB	内六角冲击批头系列75mm	10	200	2000
SGS6375 H5.0-IB	内六角冲击批头系列75mm	10	200	2000
SGS6375 H6.0-IB	内六角冲击批头系列75mm	10	200	2000
SGS6375 H7.0-IB	内六角冲击批头系列75mm	10	200	2000
SGS6375 H8.0-IB	内六角冲击批头系列75mm	10	200	2000
SGS63100 H1.5-IB	内六角冲击批头系列100mm	10	100	1000
SGS63100 H2.0-IB	内六角冲击批头系列100mm	10	100	1000
SGS63100 H2.5-IB	内六角冲击批头系列100mm	10	100	1000
SGS63100 H3.0-IB	内六角冲击批头系列100mm	10	100	1000
SGS63100 H4.0-IB	内六角冲击批头系列100mm	10	100	1000
SGS63100 H5.0-IB	内六角冲击批头系列100mm	10	100	1000
SGS63100 H6.0-IB	内六角冲击批头系列100mm	10	100	1000
SGS63100 H7.0-IB	内六角冲击批头系列100mm	10	100	1000
SGS63100 H8.0-IB	内六角冲击批头系列100mm	10	100	1000
SGS63150 H1.5-IB	内六角冲击批头系列150mm	10	100	1000
SGS63150 H2.0-IB	内六角冲击批头系列150mm	10	100	1000
SGS63150 H2.5-IB	内六角冲击批头系列150mm	10	100	1000
SGS63150 H3.0-IB	内六角冲击批头系列150mm	10	100	1000
SGS63150 H4.0-IB	内六角冲击批头系列150mm	10	100	1000
SGS63150 H5.0-IB	内六角冲击批头系列150mm	10	100	1000
SGS63150 H6.0-IB	内六角冲击批头系列150mm	10	100	1000



**我们制造高标准批头，
种类全面，满足所有工业及手工业领域的需求。**

We make high standard bits,
A comprehensive range to meet the needs of all industrial and handicraft fields

6.35mm系列单头一字冲击批头(S2材料) 1/4" Hexagon driver series Slotted impact screw bits(S2 material)

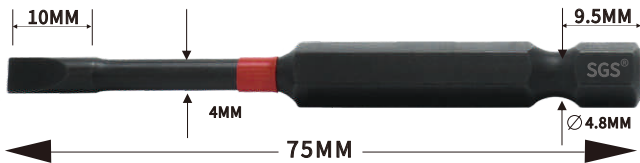

单头一字冲击批



- 高端进口S2材质
- 特殊热处理工艺, HRC61±1度
- 表面黑磷化处理+PE管
- 规格齐全
- 可定制其他颜色, 长度, 杆径, 头型及造型

- .High-end imported S2 material
- .Special heat treatment process, HRC61±1 degree
- .Surface black phosphating treatment+PE pipe
- .Complete specifications
- .Other colors,lengths,rod diameters, head shapes and shapes can be customized

订货号/Item No	品名/Product Name	支/PCS	支/PCS	支/PCS
SGS6325 SL3-IB	一字冲击批系列25mm	20	400	4000
SGS6325 SL4-IB	一字冲击批系列25mm	20	400	4000
SGS6325 SL5-IB	一字冲击批系列25mm	20	400	4000
SGS6325 SL6-IB	一字冲击批系列25mm	20	400	4000
SGS6350 SL3-IB	一字冲击批系列50mm	10	200	2000
SGS6350 SL4-IB	一字冲击批系列50mm	10	200	2000
SGS6350 SL5-IB	一字冲击批系列50mm	10	200	2000
SGS6350 SL6-IB	一字冲击批系列50mm	10	200	2000
SGS6370 SL3-IB	一字冲击批系列70mm	10	100	1000
SGS6370 SL4-IB	一字冲击批系列70mm	10	100	1000
SGS6370 SL5-IB	一字冲击批系列70mm	10	100	1000
SGS6370 SL6-IB	一字冲击批系列70mm	10	100	1000
SGS63150 SL3-IB	一字冲击批系列150mm	10	100	1000
SGS63150 SL4-IB	一字冲击批系列150mm	10	100	1000
SGS63150 SL5-IB	一字冲击批系列150mm	10	100	1000
SGS63150 SL6-IB	一字冲击批系列150mm	10	100	1000

6.35mm系列单头方形冲击批头(S2材料) 1/4" Hexagon driver series Square impact screw bits(S2 material)

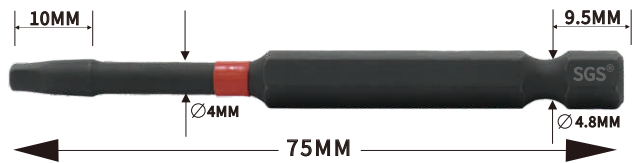

单头方形冲击批



- 高端进口S2材质
- 特殊热处理工艺, HRC61±1度
- 表面黑磷化处理+PE管
- 规格齐全
- 可定制其他颜色, 长度, 杆径, 头型及造型

- .High-end imported S2 material
- .Special heat treatment process, HRC61±1 degree
- .Surface black phosphating treatment+PE pipe
- .Complete specifications
- .Other colors,lengths,rod diameters, head shapes and shapes can be customized

订货号/Item No	品名/Product Name	支/PCS	支/PCS	支/PCS
SGS6325 SQ0-IB	方形冲击批头系列25mm	20	400	4000
SGS6325 SQ1-IB	方形冲击批头系列25mm	20	400	4000
SGS6325 SQ2-IB	方形冲击批头系列25mm	20	400	4000
SGS6325 SQ3-IB	方形冲击批头系列25mm	20	400	4000
SGS6325 SQ4-IB	方形冲击批头系列25mm	20	400	4000
SGS6350 SQ0-IB	方形冲击批头系列50mm	10	200	2000
SGS6350 SQ1-IB	方形冲击批头系列50mm	10	200	2000
SGS6350 SQ2-IB	方形冲击批头系列50mm	10	200	2000
SGS6350 SQ3-IB	方形冲击批头系列50mm	10	200	2000
SGS6350 SQ4-IB	方形冲击批头系列50mm	10	200	2000
SGS63150 SQ0-IB	方形冲击批头系列150mm	10	100	1000
SGS63150 SQ1-IB	方形冲击批头系列150mm	10	100	1000
SGS63150 SQ2-IB	方形冲击批头系列150mm	10	100	1000
SGS63150 SQ3-IB	方形冲击批头系列150mm	10	100	1000
SGS63150 SQ4-IB	方形冲击批头系列150mm	10	100	1000

防滑批头

防滑纹可以提高批头对螺丝的抓握力

Anti-slip lines can improve the grip of the screw bits on the screws



■ 6.35mm系列防滑批头(S2材料) 1/4" Hexagon driver series anti slip screw bits (S2 material)

订货号/Item No	品名/Product Name	 支/PCS	 支/PCS	 支/PCS
SGS6325 PH2防滑	单头十字防滑批头25mm	20	400	4000
SGS6325 PH3防滑	单头十字防滑批头25mm	20	400	4000
SGS6350 6.0PH2防滑	单头十字防滑批头50mm	10	200	2000
SGS6365 6.0PH2防滑	单头十字防滑批头65mm	10	200	2000
SGS6375 6.0PH2防滑	单头十字防滑批头75mm	10	100	1000
SGS63100 6.0PH2防滑	单头十字防滑批头100mm	10	100	1000
SGS6365 PH2PH2-C(6.0)(防滑)	双头十字防滑批头65mm	10	200	2000
SGS63100 PH2PH2-C(6.0)(防滑)	双头十字防滑批头100mm	10	100	1000
SGS63150 PH2PH2-C(6.0)(防滑)	双头十字防滑批头150mm	10	100	1000

Bamboo Shape Screw Bits

竹节批头

灵感来源于坚韧的竹子

Inspiration from the tough bamboo

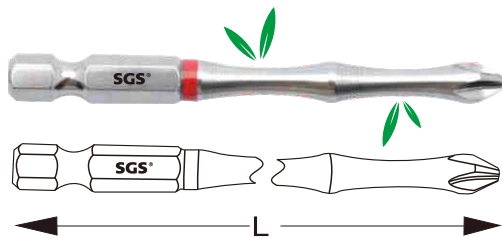

PH2

对边:6.35MM



- 高端进口S2材质
- 特殊热处理工艺, HRC61±1度
- 表面本色喷砂处理(可做其他表面处理:精抛, 黑磷化等)
- 用途: 增强磁性及定位

.High-end imported S2 material
.Special heat treatment process, HRC61±1 degree
.Sandblasted surface (Others are available: Fine polishing, black phosphating, etc.)
.Usage: Enhance the magnetism and positioning

订货号/Item No	品名/Product Name	支/PCS	支/PCS	支/PCS
SGS6350 PH2-DT	单头竹节批头50mm	10	200	2000
SGS6375 PH2-DT	单头竹节批头75mm	10	100	1000
SGS63100 PH2-DT	单头竹节批头100mm	10	100	1000
SGS63150 PH2-DT	单头竹节批头150mm	10	100	1000

电工十一字批头

处理电路和插座等电工任务时的理想选择

Ideal choice for electrical task such as Circuits and sockets



十一字电工批



- 高端进口S2材质
- 特殊热处理工艺, HRC61±1度
- 规格齐全
- 可定制其他颜色, 长度, 杆径, 头型及造型

- .High-end imported S2 material
- .Special heat treatment process, HRC61±1 degree
- .Complete specifications
- .Other colors, lengths, rod diameters, head shapes and shapes can be customized

订货号/Item No	品名/Product Name	支/PCS	支/PCS	支/PCS
SGS6365 5.0FPH1	电工专用批头65mm	10	200	2000
SGS6365 5.5FPH2	电工专用批头65mm	10	200	2000
SGS6365 7.0FPH3	电工专用批头65mm	10	200	2000
SGS63110 5.0FPH1	电工专用批头110mm	10	100	1000
SGS63110 5.5FPH2	电工专用批头110mm	10	100	1000
SGS63110 7.0FPH3	电工专用批头110mm	10	100	1000
SGS63150 5.0FPH1	电工专用批头150mm	10	100	1000
SGS63150 5.5FPH2	电工专用批头150mm	10	100	1000
SGS63150 7.0FPH3	电工专用批头150mm	10	100	1000

Single Head Phillips Screw Bits

单头十字批头

高效率、高精度、高灵活性和通用性好,使用范围广泛

High efficiency, high precision, high flexibility, strong versatility, wide range of use



货号命名规则

ITEM NUMBER NAMING RULES

SGS 6.3 50 6.0 PH2
 品牌名称 驱动杆径 批头长度 刀杆直径 头型尺寸
 BRAND NAME Drive Rod Diameter Batch head length Shank Diameter Head size

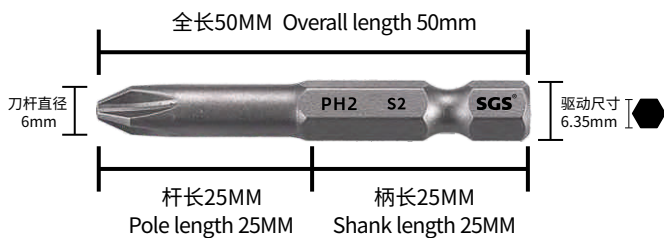

批头头型大小

Batch head size

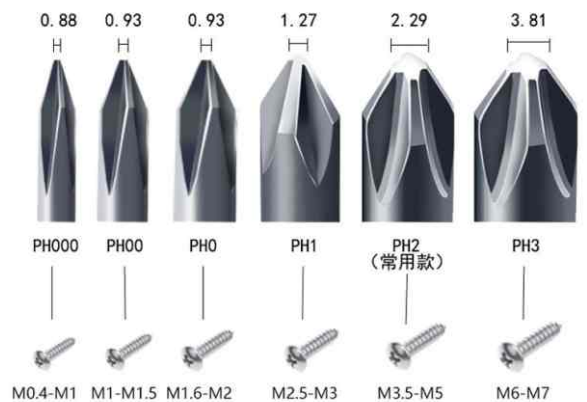

我们制造高标准批头，
种类全面，满足所有工业及手工业领域的需求。

We make high standard bits,
A comprehensive range to meet the needs of all industrial and handicraft fields



6.35mm系列十字螺丝批头 1/4" Hexagon Driver Phillips Power Bits

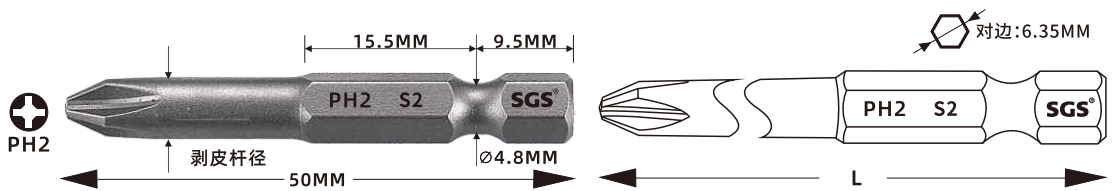

单头十字

- 高端进口S2材质 .High-end imported S2 material
- 特殊热处理工艺, HRC61±1度 .Special heat treatment process, HRC61±1 degree
- 表面本色喷砂处理(可做其他表面处理: 精抛, 黑磷化等) .Sandblasted surface (Others are available: Fine polishing, black phosphating, etc.)



订货号/Item No	品名 Product Name	Ø 杆径	📦	📦	📦	订货号/Item No	品名 Product Name	Ø 杆径	📦	📦	📦
SGS6325 PH0	单头十字批头25mm	/	20	400	4000	SGS6365 3.0PH2	单头十字批头65mm	3.0mm	10	200	2000
SGS6325 PH1	单头十字批头25mm	/	20	400	4000	SGS6365 3.5PH1	单头十字批头65mm	3.5mm	10	200	2000
SGS6325 PH2	单头十字批头25mm	/	20	400	4000	SGS6365 3.5PH2	单头十字批头65mm	3.5mm	10	200	2000
SGS6325 PH3	单头十字批头25mm	/	20	400	4000	SGS6365 4.0PH1	单头十字批头65mm	4.0mm	10	200	2000
SGS6325 PH4	单头十字批头25mm	/	20	400	4000	SGS6365 4.0PH2	单头十字批头65mm	4.0mm	10	200	2000
SGS6350 1.2PH000	单头十字批头50mm	1.2mm	10	200	2000	SGS6365 4.5PH1	单头十字批头65mm	4.5mm	10	200	2000
SGS6350 1.6PH00	单头十字批头50mm	1.6mm	10	200	2000	SGS6365 4.5PH2	单头十字批头65mm	4.5mm	10	200	2000
SGS6350 2.0PH0	单头十字批头50mm	2.0mm	10	200	2000	SGS6365 5.0PH1	单头十字批头65mm	5.0mm	10	200	2000
SGS6350 2.0PH00	单头十字批头50mm	2.0mm	10	200	2000	SGS6365 5.0PH2	单头十字批头65mm	5.0mm	10	200	2000
SGS6350 2.0PH1	单头十字批头50mm	2.0mm	10	200	2000	SGS6365 6.0PH1	单头十字批头65mm	6.0mm	10	200	2000
SGS6350 2.5PH0	单头十字批头50mm	2.5mm	10	200	2000	SGS6365 6.0PH2	单头十字批头65mm	6.0mm	10	200	2000
SGS6350 2.5PH00	单头十字批头50mm	2.5mm	10	200	2000	SGS6365 6.0PH3	单头十字批头65mm	6.0mm	10	200	2000
SGS6350 2.5PH1	单头十字批头50mm	2.5mm	10	200	2000	SGS6370 5.0PH2	单头十字批头70mm	5.0mm	10	100	1000
SGS6350 3.0PH0	单头十字批头50mm	3.0mm	10	200	2000	SGS6370 5.0PH3	单头十字批头70mm	5.0mm	10	100	1000
SGS6350 3.0PH1	单头十字批头50mm	3.0mm	10	200	2000	SGS6370 6.0PH3	单头十字批头70mm	6.0mm	10	100	1000
SGS6350 3.0PH2	单头十字批头50mm	3.0mm	10	200	2000	SGS6375 2.0PH1	单头十字批头75mm	2.0mm	10	100	1000
SGS6350 3.5PH0	单头十字批头50mm	3.5mm	10	200	2000	SGS6375 2.5PH0	单头十字批头75mm	2.5mm	10	100	1000
SGS6350 3.5PH1	单头十字批头50mm	3.5mm	10	200	2000	SGS6375 3.0PH1	单头十字批头75mm	3.0mm	10	100	1000
SGS6350 3.5PH2	单头十字批头50mm	3.5mm	10	200	2000	SGS6375 3.5PH1	单头十字批头75mm	3.5mm	10	100	1000
SGS6350 4.0PH1	单头十字批头50mm	4.0mm	10	200	2000	SGS6375 3.5PH2	单头十字批头75mm	3.5mm	10	100	1000
SGS6350 4.0PH2	单头十字批头50mm	4.0mm	10	200	2000	SGS6375 4.0PH0	单头十字批头75mm	4.0mm	10	100	1000
SGS6350 4.5PH1	单头十字批头50mm	4.5mm	10	200	2000	SGS6375 4.0PH1	单头十字批头75mm	4.0mm	10	100	1000
SGS6350 4.5PH2	单头十字批头50mm	4.5mm	10	200	2000	SGS6375 4.0PH2	单头十字批头75mm	4.0mm	10	100	1000
SGS6350 5.0PH1	单头十字批头50mm	5.0mm	10	200	2000	SGS6375 4.5PH1	单头十字批头75mm	4.5mm	10	100	1000
SGS6350 5.0PH2	单头十字批头50mm	5.0mm	10	200	2000	SGS6375 4.5PH2	单头十字批头75mm	4.5mm	10	100	1000
SGS6350 6.0PH1	单头十字批头50mm	6.0mm	10	200	2000	SGS6375 5.0PH1	单头十字批头75mm	5.0mm	10	100	1000
SGS6350 6.0PH2	单头十字批头50mm	6.0mm	10	200	2000	SGS6375 5.0PH2	单头十字批头75mm	5.0mm	10	100	1000
SGS6350 6.0PH3	单头十字批头50mm	6.0mm	10	200	2000	SGS6375 6.0PH1	单头十字批头75mm	6.0mm	10	100	1000
SGS6350 PH2	单头十字批头50mm	/	10	200	2000	SGS6375 6.0PH2	单头十字批头75mm	6.0mm	10	100	1000
SGS6350 PH4	单头十字批头50mm	/	10	200	2000	SGS6375 6.0PH3	单头十字批头75mm	6.0mm	10	100	1000
SGS6365 2.0PH0	单头十字批头65mm	2.0mm	10	200	2000	SGS6380 2.0PH0	单头十字批头80mm	2.0mm	10	100	1000
SGS6365 2.5PH0	单头十字批头65mm	2.5mm	10	200	2000	SGS6380 2.0PH1	单头十字批头80mm	2.0mm	10	100	1000
SGS6365 2.5PH1	单头十字批头65mm	2.5mm	10	200	2000	SGS6380 2.5PH0	单头十字批头80mm	2.5mm	10	100	1000
SGS6365 3.0PH0	单头十字批头65mm	3.0mm	10	200	2000	SGS6380 2.5PH1	单头十字批头80mm	2.5mm	10	100	1000
SGS6365 3.0PH1	单头十字批头65mm	3.0mm	10	200	2000	SGS6380 3.0PH1	单头十字批头80mm	3.0mm	10	100	1000

我们制造高标准批头，
种类全面，满足所有工业及手工业领域的需求。

We make high standard bits,
A comprehensive range to meet the needs of all industrial and handicraft fields



■ 6.35mm系列十字螺丝批头 1/4"Hexagon Driver Phillips Power Bits

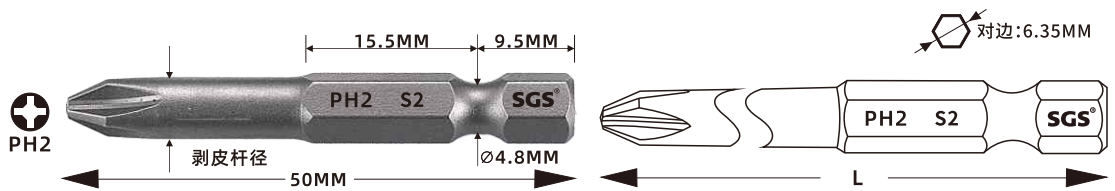

单头十字

- 高端进口S2材质 .High-end imported S2 material
- 特殊热处理工艺, HRC61±1度 .Special heat treatment process, HRC61±1 degree
- 表面本色喷砂处理(可做其他表面处理:精抛, 黑磷化等) .Sandblasted surface (Others are available: Fine polishing, black phosphating, etc.)

订货号/Item No	品名 Product Name	∅ 杆径	📦	📦	📦	订货号/Item No	品名 Product Name	∅ 杆径	📦	📦	📦
SGS6380 3.0PH2	单头十字批头80mm	3.0mm	10	100	1000	SGS63110 5.0PH2	单头十字批头110mm	5.0mm	10	100	1000
SGS6380 3.5PH1	单头十字批头80mm	3.5mm	10	100	1000	SGS63110 6.0PH2	单头十字批头110mm	6.0mm	10	100	1000
SGS6380 4.0PH1	单头十字批头80mm	4.0mm	10	100	1000	SGS63110 6.0PH3	单头十字批头110mm	6.0mm	10	100	1000
SGS6380 4.0PH2	单头十字批头80mm	4.0mm	10	100	1000	SGS63120 6.0PH2	单头十字批头120mm	6.0mm	10	100	1000
SGS6380 4.5PH2	单头十字批头80mm	4.5mm	10	100	1000	SGS63150 2.5PH0	单头十字批头150mm	2.5mm	10	100	1000
SGS6380 5.0PH1	单头十字批头80mm	5.0mm	10	100	1000	SGS63150 2.5PH1	单头十字批头150mm	2.5mm	10	100	1000
SGS6380 5.0PH2	单头十字批头80mm	5.0mm	10	100	1000	SGS63150 3.0PH1	单头十字批头150mm	3.0mm	10	100	1000
SGS6380 6.0PH2	单头十字批头80mm	6.0mm	10	100	1000	SGS63150 3.0PH2	单头十字批头150mm	3.0mm	10	100	1000
SGS63100 2.5PH0	单头十字批头100mm	2.5mm	10	100	1000	SGS63150 3.5PH1	单头十字批头150mm	3.5mm	10	100	1000
SGS63100 2.5PH1	单头十字批头100mm	2.5mm	10	100	1000	SGS63150 3.5PH2	单头十字批头150mm	3.5mm	10	100	1000
SGS63100 3.0PH1	单头十字批头100mm	3.0mm	10	100	1000	SGS63150 4.0PH1	单头十字批头150mm	4.0mm	10	100	1000
SGS63100 3.0PH2	单头十字批头100mm	3.0mm	10	100	1000	SGS63150 4.0PH2	单头十字批头150mm	4.0mm	10	100	1000
SGS63100 3.5PH1	单头十字批头100mm	3.5mm	10	100	1000	SGS63150 4.5PH1	单头十字批头150mm	4.5mm	10	100	1000
SGS63100 4.0PH1	单头十字批头100mm	4.0mm	10	100	1000	SGS63150 4.5PH2	单头十字批头150mm	4.5mm	10	100	1000
SGS63100 4.0PH2	单头十字批头100mm	4.0mm	10	100	1000	SGS63150 5.0PH1	单头十字批头150mm	5.0mm	10	100	1000
SGS63100 4.5PH1	单头十字批头100mm	4.5mm	10	100	1000	SGS63150 5.0PH2	单头十字批头150mm	5.0mm	10	100	1000
SGS63100 4.5PH2	单头十字批头100mm	4.5mm	10	100	1000	SGS63150 6.0PH1	单头十字批头150mm	6.0mm	10	100	1000
SGS63100 5.0PH1	单头十字批头100mm	5.0mm	10	100	1000	SGS63150 6.0PH2	单头十字批头150mm	6.0mm	10	100	1000
SGS63100 5.0PH2	单头十字批头100mm	5.0mm	10	100	1000	SGS63150 6.0PH3	单头十字批头150mm	6.0mm	10	100	1000
SGS63100 6.0PH1	单头十字批头100mm	6.0mm	10	100	1000	SGS63200 3.0PH1	单头十字批头200mm	3.0mm	10	100	1000
SGS63100 6.0PH2	单头十字批头100mm	6.0mm	10	100	1000	SGS63200 4.0PH1	单头十字批头200mm	4.0mm	10	100	1000
SGS63100 6.0PH3	单头十字批头100mm	6.0mm	10	100	1000	SGS63200 4.0PH2	单头十字批头200mm	4.0mm	10	100	1000
SGS63110 2.0PH1	单头十字批头110mm	2.0mm	10	100	1000	SGS63200 4.5PH1	单头十字批头200mm	4.5mm	10	100	1000
SGS63110 2.5PH0	单头十字批头110mm	2.5mm	10	100	1000	SGS63200 4.5PH2	单头十字批头200mm	4.5mm	10	100	1000
SGS63110 2.5PH1	单头十字批头110mm	2.5mm	10	100	1000	SGS63200 5.0PH2	单头十字批头200mm	5.0mm	10	100	1000
SGS63110 3.0PH0	单头十字批头110mm	3.0mm	10	100	1000	SGS63200 6.0PH1	单头十字批头200mm	6.0mm	10	100	1000
SGS63110 3.0PH1	单头十字批头110mm	3.0mm	10	100	1000	SGS63200 6.0PH2	单头十字批头200mm	6.0mm	10	100	1000
SGS63110 3.0PH2	单头十字批头110mm	3.0mm	10	100	1000	SGS63250 4.0PH2	单头十字批头250mm	4.0mm	5	50	500
SGS63110 3.5PH1	单头十字批头110mm	3.5mm	10	100	1000	SGS63250 4.5PH2	单头十字批头250mm	4.5mm	5	50	500
SGS63110 4.0PH1	单头十字批头110mm	4.0mm	10	100	1000	SGS63250 5.0PH2	单头十字批头250mm	5.0mm	5	50	500
SGS63110 4.0PH2	单头十字批头110mm	4.0mm	10	100	1000	SGS63250 6.0PH2	单头十字批头250mm	6.0mm	5	50	500
SGS63110 4.5PH1	单头十字批头110mm	4.5mm	10	100	1000	SGS63300 4.0PH2	单头十字批头300mm	4.0mm	5	50	500
SGS63110 4.5PH2	单头十字批头110mm	4.5mm	10	100	1000	SGS63300 5.0PH2	单头十字批头300mm	5.0mm	5	50	500
SGS63110 5.0PH1	单头十字批头110mm	5.0mm	10	100	1000	SGS63300 6.0PH2	单头十字批头300mm	6.0mm	5	50	500

我们制造高标准批头，
种类全面，满足所有工业及手工业领域的需求。

We make high standard bits,
A comprehensive range to meet the needs of all industrial and handicraft fields



■ 单头磁圈定位批头/Single Head magnetic ring positioning Screw bits

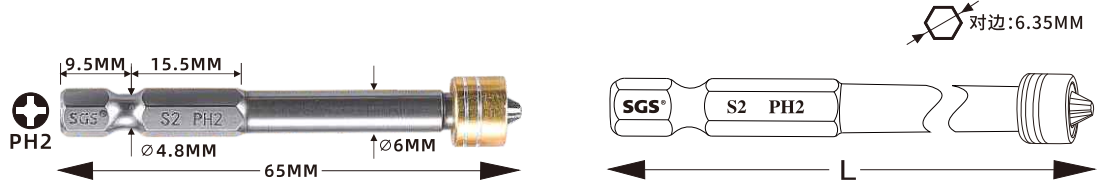

单头H款

- 高端进口S2材质 .High-end imported S2 material
- 特殊热处理工艺, HRC61±1度 .Special heat treatment process, HRC61±1 degree
- 表面本色喷砂处理(可做其他表面处理:精抛, 黑磷化等) .Sandblasted surface (Others are available: Fine polishing, black phosphating, etc.)
- 磁圈可拆卸 .The magnetic coil is detachable
- 用途:增强磁性及定位 .Usage: Enhance the magnetism and positioning

订货号/Item No	品名/Product Name	支/PCS	支/PCS	支/PCS
SGS6365 6.0PH2-HA	单头磁圈定位批头65mm	10	200	1000
SGS63100 6.0PH2-HA	单头磁圈定位批头100mm	10	100	1000
SGS6365 6.0PH2-HB	单头磁圈定位批头65mm	10	200	1000
SGS63100 6.0PH2-HB	单头磁圈定位批头100mm	10	100	1000

■ 6.35mm系列单头米字螺丝批头(S2材料) 1/4" Hexagon driver series single head Pozzi shaped screw bits (S2 material)

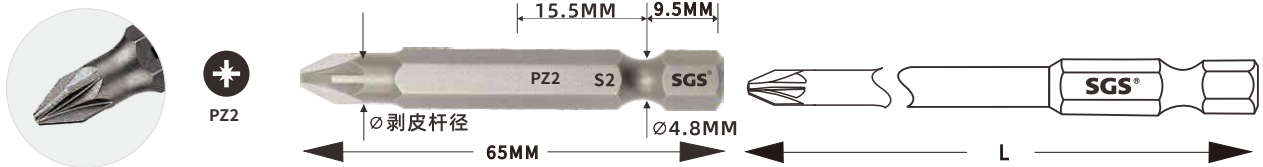

单头米字

- 高端进口S2材质 .High-end imported S2 material
- 特殊热处理工艺, HRC61±1度 .Special heat treatment process, HRC61±1 degree
- 表面本色喷砂处理(可做其他表面处理:精抛, 黑磷化等) .Sandblasted surface (Others are available: Fine polishing, black phosphating, etc.)

订货号/Item No	品名 Product Name	支/PCS	支/PCS	支/PCS	订货号/Item No	品名 Product Name	支/PCS	支/PCS	支/PCS
SGS6325 PZ1	单头米字批头25mm	20	400	4000	SGS6365 6.0PZ3	单头米字批头65mm	10	200	2000
SGS6325 PZ2	单头米字批头25mm	20	400	4000	SGS6375 6.0PZ2	单头米字批头75mm	10	100	1000
SGS6325 PZ3	单头米字批头25mm	20	400	4000	SGS6375 PZ2	单头米字批头75mm	10	100	1000
SGS6350 6.0PZ1	单头米字批头50mm	10	200	2000	SGS6375 PZ3	单头米字批头75mm	10	100	1000
SGS6350 6.0PZ2	单头米字批头50mm	10	200	2000	SGS63100 PZ2	单头米字批头100mm	10	100	1000
SGS6350 6.0PZ3	单头米字批头50mm	10	200	2000	SGS63150 6.0PZ2	单头米字批头150mm	10	100	1000
SGS6350 PZ2	单头米字批头50mm	10	200	2000	SGS63150 6.0PZ3	单头米字批头150mm	10	100	1000
SGS6350 PZ3	单头米字批头50mm	10	200	2000	SGS63150 PZ2	单头米字批头150mm	10	100	1000
SGS6365 6.0PZ2	单头米字批头65mm	10	200	2000	SGS63200 PZ2	单头米字批头200mm	10	100	1000

single head
slotted screw bits

单头一字批头

也称为平头或刀口
是家用常见的一种螺丝批头类型

It is a common household use screw bit

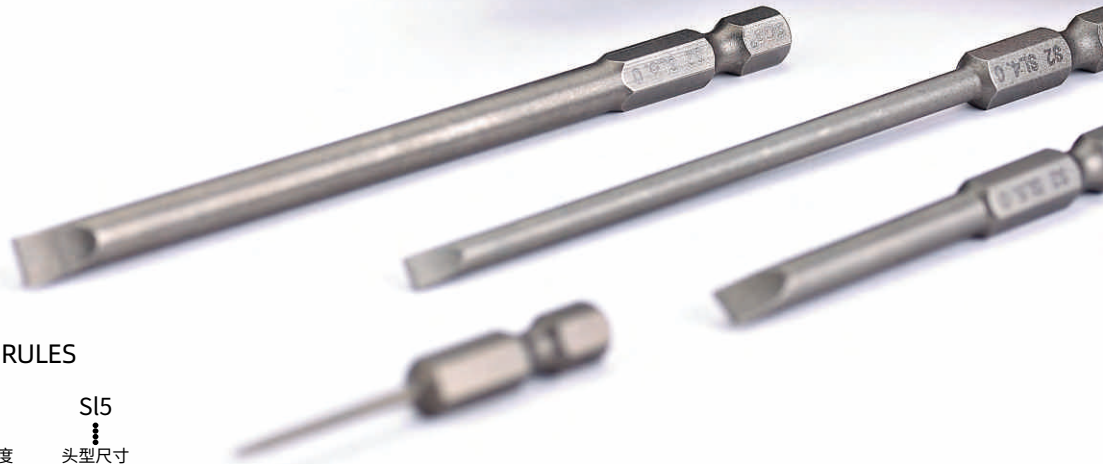

货号命名规则

ITEM NUMBER NAMING RULES

SGS	63	50	SL5
品牌名称	驱动杆径	批头长度	头型尺寸
BRAND NAME	Drive Rod Diameter	Batch head length	Head size

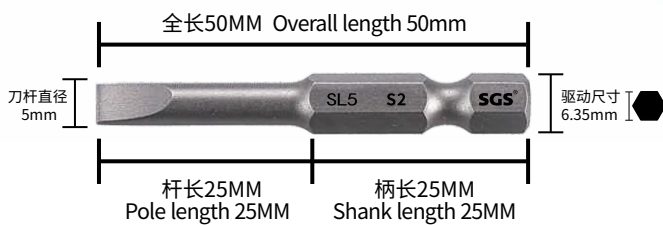

相匹配螺丝
Matching screws



**我们制造高标准批头，
种类全面，满足所有工业及手工业领域的需求。**

We make high standard bits,
A comprehensive range to meet the needs of all industrial and handicraft fields



■ 6.35mm系列单头一字螺丝批头 1/4" Hexagon Driver Slotted Power Bits



单头一字

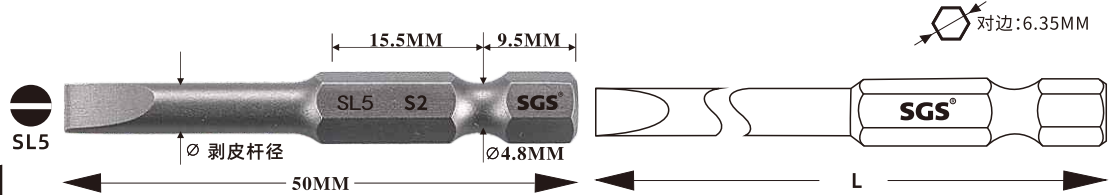

- 高端进口S2材质 .High-end imported S2 material
- 特殊热处理工艺, HRC61±1度 .Special heat treatment process, HRC61±1 degree
- 表面本色喷砂处理(可做其他表面处理: 精抛, 黑磷化等) .Sandblasted surface (Others are available: Fine polishing, black phosphating, etc.)

订货号/Item No	品名 Product Name				订货号/Item No	品名 Product Name			
SGS6325 SL3	单头一字批头25mm	20	400	4000	SGS6375 SL5.0	单头一字批头75mm	10	100	1000
SGS6325 SL4	单头一字批头25mm	20	400	4000	SGS6375 SL6.0	单头一字批头75mm	10	100	1000
SGS6325 SL5	单头一字批头25mm	20	400	4000	SGS6375 SL10.0	单头一字批头75mm	10	100	1000
SGS6325 SL6	单头一字批头25mm	20	400	4000	SGS6380 SL5.0	单头一字批头80mm	10	100	1000
SGS6350 SL2.0	单头一字批头50mm	10	200	2000	SGS63100 SL3.0	单头一字批头100mm	10	100	1000
SGS6350 SL2.5	单头一字批头50mm	10	200	2000	SGS63100 SL4.0	单头一字批头100mm	10	100	1000
SGS6350 SL3.0	单头一字批头50mm	10	200	2000	SGS63100 SL4.5	单头一字批头100mm	10	100	1000
SGS6350 SL4.0	单头一字批头50mm	10	200	2000	SGS63100 SL5.0	单头一字批头100mm	10	100	1000
SGS6350 SL5.0	单头一字批头50mm	10	200	2000	SGS63100 SL10.0	单头一字批头100mm	10	100	1000
SGS6350 SL6.0	单头一字批头50mm	10	200	2000	SGS63100 SL6.0	单头一字批头100mm	10	100	1000
SGS6350 SL8.0	单头一字批头50mm	10	200	2000	SGS63110 SL2.5	单头一字批头110mm	10	100	1000
SGS6350 SL10.0	单头一字批头50mm	10	200	2000	SGS63110 SL3.0	单头一字批头110mm	10	100	1000
SGS6365 SL3.0	单头一字批头65mm	10	200	2000	SGS63110 SL3.5	单头一字批头110mm	10	100	1000
SGS6365 SL4.0	单头一字批头65mm	10	200	2000	SGS63110 SL4.0	单头一字批头110mm	10	100	1000
SGS6365 SL5.0	单头一字批头65mm	10	200	2000	SGS63110 SL5.0	单头一字批头110mm	10	100	1000
SGS6365 SL6.0	单头一字批头65mm	10	200	2000	SGS63110 SL6.0	单头一字批头110mm	10	100	1000
SGS6375 SL2.0	单头一字批头75mm	10	100	1000	SGS63150 SL3.0	单头一字批头150mm	10	100	1000
SGS6375 SL2.5	单头一字批头75mm	10	100	1000	SGS63150 SL4.0	单头一字批头150mm	10	100	1000
SGS6375 SL3.0	单头一字批头75mm	10	100	1000	SGS63150 SL5.0	单头一字批头150mm	10	100	1000
SGS6375 SL4.0	单头一字批头75mm	10	100	1000	SGS63150 SL6.0	单头一字批头150mm	10	100	1000

Single Head Torx Screw Bits

梅花批头

在工程、机械维修等领域中非常适用

Widely used in Engineering, mechanical maintenance



货号命名规则

ITEM NUMBER NAMING RULES

SGS	63	50	TT27
品牌名称	驱动杆径	批头长度	头型尺寸
BRAND NAME	Drive Rod Diameter	Batch head length	Head size

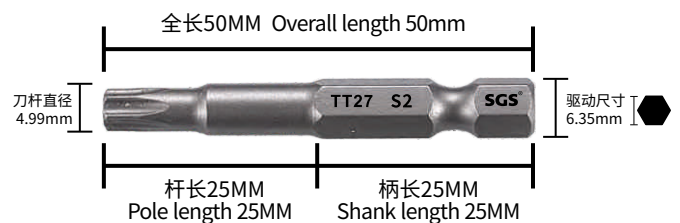

我们制造高标准批头，
种类全面，满足所有工业及手工业领域的需求。

We make high standard bits,
A comprehensive range to meet the needs of all industrial and handicraft fields



6.35mm系列梅花带孔螺丝批头 1/4" Hexagon Driver Torx Screw bits



对边:6.35MM

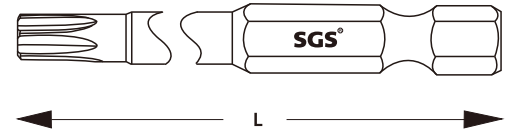

单头梅花

- 高端进口S2材质 .High-end imported S2 material
- 特殊热处理工艺, HRC61±1度 .Special heat treatment process, HRC61±1 degree
- 表面本色喷砂处理(可做其他表面处理:精抛, 黑磷化等) .Sandblasted surface (Others are available: Fine polishing, black phosphating, etc.)

订货号/Item No	品名/Product Name				订货号/Item No	品名/Product Name			
SGS6325 T7	单头梅花批头25mm	20	400	4000	SGS6365 T7	单头梅花批头65mm	10	200	2000
SGS6325 T8	单头梅花批头25mm	20	400	4000	SGS6365 T8	单头梅花批头65mm	10	200	2000
SGS6325 T9	单头梅花批头25mm	20	400	4000	SGS6365 T9	单头梅花批头65mm	10	200	2000
SGS6325 T10	单头梅花批头25mm	20	400	4000	SGS6365 T10	单头梅花批头65mm	10	200	2000
SGS6325 T15	单头梅花批头25mm	20	400	4000	SGS6365 T15	单头梅花批头65mm	10	200	2000
SGS6325 T20	单头梅花批头25mm	20	400	4000	SGS6365 T20	单头梅花批头65mm	10	200	2000
SGS6325 T25	单头梅花批头25mm	20	400	4000	SGS6365 T25	单头梅花批头65mm	10	200	2000
SGS6325 T27	单头梅花批头25mm	20	400	4000	SGS6365 T27	单头梅花批头65mm	10	200	2000
SGS6325 T30	单头梅花批头25mm	20	400	4000	SGS6365 T30	单头梅花批头65mm	10	200	2000
SGS6325 T40	单头梅花批头25mm	20	400	4000	SGS6365 T40	单头梅花批头65mm	10	200	2000
SGS6350 T5	单头梅花批头50mm	10	200	2000	SGS6365 T45	单头梅花批头65mm	10	100	1000
SGS6350 T6	单头梅花批头50mm	10	200	2000	SGS6365 T50	单头梅花批头65mm	10	100	1000
SGS6350 T7	单头梅花批头50mm	10	200	2000	SGS6375 T5	单头梅花批头75mm	10	100	1000
SGS6350 T8	单头梅花批头50mm	10	200	2000	SGS6375 T8	单头梅花批头75mm	10	100	1000
SGS6350 T9	单头梅花批头50mm	10	200	2000	SGS6375 T10	单头梅花批头75mm	10	100	1000
SGS6350 T10	单头梅花批头50mm	10	200	2000	SGS6375 T15	单头梅花批头75mm	10	100	1000
SGS6350 T15	单头梅花批头50mm	10	200	2000	SGS6375 T20	单头梅花批头75mm	10	100	1000
SGS6350 T20	单头梅花批头50mm	10	200	2000	SGS6375 T25	单头梅花批头75mm	10	100	1000
SGS6350 T25	单头梅花批头50mm	10	200	2000	SGS6375 T27	单头梅花批头75mm	10	100	1000
SGS6350 T27	单头梅花批头50mm	10	200	2000	SGS6375 T30	单头梅花批头75mm	10	100	1000
SGS6350 T30	单头梅花批头50mm	10	200	2000	SGS6375 T40	单头梅花批头75mm	10	100	1000
SGS6350 T40	单头梅花批头50mm	10	100	1000	SGS6380 T7	单头梅花批头80mm	10	100	1000
SGS6350 T45	单头梅花批头50mm	10	100	1000	SGS6380 T8	单头梅花批头80mm	10	100	1000
SGS6350 T50	单头梅花批头50mm	10	200	2000	SGS6380 T9	单头梅花批头80mm	10	100	1000
SGS6365 T5	单头梅花批头65mm	10	200	2000	SGS6380 T10	单头梅花批头80mm	10	100	1000
SGS6365 T6	单头梅花批头65mm	10	200	2000	SGS6380 T15	单头梅花批头80mm	10	100	1000

我们制造高标准批头，
种类全面，满足所有工业及手工业领域的需求。

We make high standard bits,
A comprehensive range to meet the needs of all industrial and handicraft fields



6.35mm系列梅花螺丝批头 1/4" Hexagon Driver Torx Screw bits



T27



对边:6.35MM

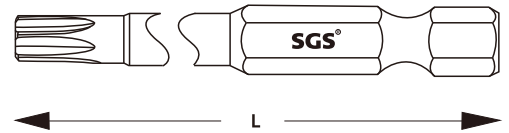

单头梅花



- 高端进口S2材质 .High-end imported S2 material
- 特殊热处理工艺, HRC61±1度 .Special heat treatment process, HRC61±1 degree
- 表面本色喷砂处理(可做其他表面处理:精抛, 黑磷化等) .Sandblasted surface (Others are available: Fine polishing, black phosphating, etc.)

订货号/Item No	品名/Product Name				订货号/Item No	品名/Product Name			
SGS6380 T20	单头梅花批头80mm	10	100	1000	SGS63110 T25	单头梅花批头110mm	10	100	1000
SGS6380 T25	单头梅花批头80mm	10	100	1000	SGS63110 T27	单头梅花批头110mm	10	100	1000
SGS6380 T27	单头梅花批头80mm	10	100	1000	SGS63110 T30	单头梅花批头110mm	10	100	1000
SGS6380 T30	单头梅花批头80mm	10	100	1000	SGS63110 T40	单头梅花批头110mm	10	100	1000
SGS6380 T40	单头梅花批头80mm	10	100	1000	SGS63110 T50	单头梅花批头110mm	10	100	1000
SGS63100 T7	单头梅花批头100mm	10	100	1000	SGS63150 T8	单头梅花批头150mm	10	100	1000
SGS63100 T8	单头梅花批头100mm	10	100	1000	SGS63150 T9	单头梅花批头150mm	10	100	1000
SGS63100 T9	单头梅花批头100mm	10	100	1000	SGS63150 T10	单头梅花批头150mm	10	100	1000
SGS63100 T10	单头梅花批头100mm	10	100	1000	SGS63150 T15	单头梅花批头150mm	10	100	1000
SGS63100 T15	单头梅花批头100mm	10	100	1000	SGS63150 T20	单头梅花批头150mm	10	100	1000
SGS63100 T20	单头梅花批头100mm	10	100	1000	SGS63150 T25	单头梅花批头150mm	10	100	1000
SGS63100 T25	单头梅花批头100mm	10	100	1000	SGS63150 T27	单头梅花批头150mm	10	100	1000
SGS63100 T27	单头梅花批头100mm	10	100	1000	SGS63150 T30	单头梅花批头150mm	10	100	1000
SGS63100 T30	单头梅花批头100mm	10	100	1000	SGS63150 T40	单头梅花批头150mm	10	100	1000
SGS63100 T40	单头梅花批头100mm	10	100	1000	SGS63200 T10	单头梅花批头200mm	10	100	1000
SGS63100 T45	单头梅花批头100mm	10	100	1000	SGS63200 T20	单头梅花批头200mm	10	100	1000
SGS63100 T50	单头梅花批头100mm	10	100	1000	SGS63200 T25	单头梅花批头200mm	10	100	1000
SGS63110 T10	单头梅花批头110mm	10	100	1000	SGS63200 T27	单头梅花批头200mm	10	100	1000
SGS63110 T15	单头梅花批头110mm	10	100	1000	SGS63200 T30	单头梅花批头200mm	10	100	1000
SGS63110 T20	单头梅花批头110mm	10	100	1000	SGS63200 T40	单头梅花批头200mm	10	100	1000

我们制造高标准批头，
种类全面，满足所有工业及手工业领域的需求。

We make high standard bits,
A comprehensive range to meet the needs of all industrial and handicraft fields



6.35mm系列梅花带孔螺丝批头 (T8开始带孔) 1/4" Hexagon Driver Torx Screw bits

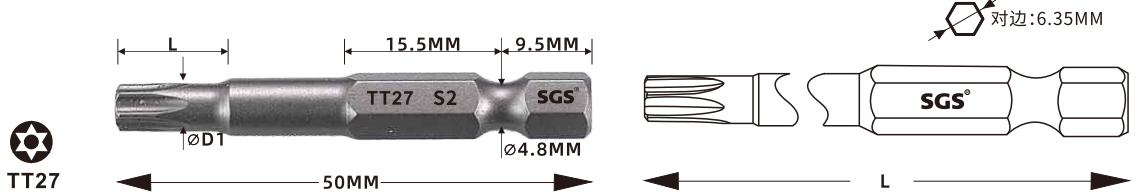

单头带孔梅花

- 高端进口S2材质 .High-end imported S2 material
- 特殊热处理工艺, HRC61±1度 .Special heat treatment process, HRC61±1 degree
- 表面本色喷砂处理(可做其他表面处理: 精抛, 黑磷化等) .Sandblasted surface (Others are available: Fine polishing, black phosphating, etc.)

订货号/Item No	品名/Product Name				订货号/Item No	品名/Product Name			
SGS6325 TT8	单头梅花带孔批头25mm	20	400	4000	SGS6365 TT9	单头梅花带孔批头65mm	10	200	2000
SGS6325 TT9	单头梅花带孔批头25mm	20	400	4000	SGS6365 TT10	单头梅花带孔批头65mm	10	200	2000
SGS6325 TT10	单头梅花带孔批头25mm	20	400	4000	SGS6365 TT15	单头梅花带孔批头65mm	10	200	2000
SGS6325 TT15	单头梅花带孔批头25mm	20	400	4000	SGS6365 TT20	单头梅花带孔批头65mm	10	200	2000
SGS6325 TT20	单头梅花带孔批头25mm	20	400	4000	SGS6365 TT25	单头梅花带孔批头65mm	10	200	2000
SGS6325 TT25	单头梅花带孔批头25mm	20	400	4000	SGS6365 TT27	单头梅花带孔批头65mm	10	200	2000
SGS6325 TT27	单头梅花带孔批头25mm	20	400	4000	SGS6365 TT30	单头梅花带孔批头65mm	10	200	2000
SGS6325 TT30	单头梅花带孔批头25mm	20	400	4000	SGS6365 TT40	单头梅花带孔批头65mm	10	200	2000
SGS6325 TT40	单头梅花带孔批头25mm	20	400	4000	SGS6365 TT45	单头梅花带孔批头65mm	10	200	2000
SGS6350 TT8	单头梅花带孔批头50mm	10	200	2000	SGS6365 TT50	单头梅花带孔批头65mm	10	200	2000
SGS6350 TT9	单头梅花带孔批头50mm	10	200	2000	SGS6375 TT8	单头梅花带孔批头75mm	10	100	1000
SGS6350 TT10	单头梅花带孔批头50mm	10	200	2000	SGS6375 TT10	单头梅花带孔批头75mm	10	100	1000
SGS6350 TT15	单头梅花带孔批头50mm	10	200	2000	SGS6375 TT15	单头梅花带孔批头75mm	10	100	1000
SGS6350 TT20	单头梅花带孔批头50mm	10	200	2000	SGS6375 TT20	单头梅花带孔批头75mm	10	100	1000
SGS6350 TT25	单头梅花带孔批头50mm	10	200	2000	SGS6375 TT25	单头梅花带孔批头75mm	10	100	1000
SGS6350 TT27	单头梅花带孔批头50mm	10	200	2000	SGS6375 TT27	单头梅花带孔批头75mm	10	100	1000
SGS6350 TT30	单头梅花带孔批头50mm	10	200	2000	SGS6375 TT30	单头梅花带孔批头75mm	10	100	1000
SGS6350 TT40	单头梅花带孔批头50mm	10	200	2000	SGS6375 TT40	单头梅花带孔批头75mm	10	100	1000
SGS6350 TT45	单头梅花带孔批头50mm	10	200	2000	SGS6380 TT8	单头梅花带孔批头80mm	10	100	1000
SGS6350 TT50	单头梅花带孔批头50mm	10	200	2000	SGS6380 TT9	单头梅花带孔批头80mm	10	100	1000
SGS6365 TT8	单头梅花带孔批头65mm	10	200	2000	SGS6380 TT10	单头梅花带孔批头80mm	10	100	1000

我们制造高标准批头，
种类全面，满足所有工业及手工业领域的需求。

We make high standard bits,
A comprehensive range to meet the needs of all industrial and handicraft fields



■ 6.35mm系列梅花带孔螺丝批头 (T8开始带孔) 1/4" Hexagon Driver Torx Screw bits

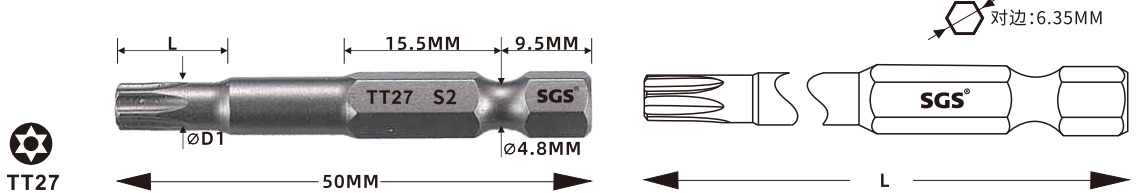

单头带孔梅花



- 高端进口S2材质 .High-end imported S2 material
- 特殊热处理工艺, HRC61±1度 .Special heat treatment process, HRC61±1 degree
- 表面本色喷砂处理(可做其他表面处理: 精抛, 黑磷化等) .Sandblasted surface (Others are available: Fine polishing, black phosphating, etc.)

订货号/Item No	品名/Product Name				订货号/Item No	品名/Product Name			
SGS6380 TT15	单头梅花带孔批头80mm	10	100	1000	SGS63110 TT25	单头梅花带孔批头110mm	10	100	1000
SGS6380 TT20	单头梅花带孔批头80mm	10	100	1000	SGS63110 TT27	单头梅花带孔批头110mm	10	100	1000
SGS6380 TT25	单头梅花带孔批头80mm	10	100	1000	SGS63110 TT30	单头梅花带孔批头110mm	10	100	1000
SGS6380 TT27	单头梅花带孔批头80mm	10	100	1000	SGS63110 TT40	单头梅花带孔批头110mm	10	100	1000
SGS6380 TT30	单头梅花带孔批头80mm	10	100	1000	SGS63110 TT50	单头梅花带孔批头110mm	8	80	800
SGS6380 TT40	单头梅花带孔批头80mm	10	100	1000	SGS63150 TT8	单头梅花带孔批头150mm	10	100	1000
SGS63100 TT8	单头梅花带孔批头100mm	10	100	1000	SGS63150 TT9	单头梅花带孔批头150mm	10	100	1000
SGS63100 TT9	单头梅花带孔批头100mm	10	100	1000	SGS63150 TT10	单头梅花带孔批头150mm	10	100	1000
SGS63100 TT10	单头梅花带孔批头100mm	10	100	1000	SGS63150 TT15	单头梅花带孔批头150mm	10	100	1000
SGS63100 TT15	单头梅花带孔批头100mm	10	100	1000	SGS63150 TT20	单头梅花带孔批头150mm	10	100	1000
SGS63100 TT20	单头梅花带孔批头100mm	10	100	1000	SGS63150 TT25	单头梅花带孔批头150mm	10	100	1000
SGS63100 TT25	单头梅花带孔批头100mm	10	100	1000	SGS63150 TT27	单头梅花带孔批头150mm	10	100	1000
SGS63100 TT27	单头梅花带孔批头100mm	10	100	1000	SGS63150 TT30	单头梅花带孔批头150mm	10	100	1000
SGS63100 TT30	单头梅花带孔批头100mm	10	100	1000	SGS63150 TT40	单头梅花带孔批头150mm	10	100	1000
SGS63100 TT40	单头梅花带孔批头100mm	10	100	1000	SGS63200 TT10	单头梅花带孔批头200mm	10	100	1000
SGS63100 TT45	单头梅花带孔批头100mm	8	80	800	SGS63200 TT20	单头梅花带孔批头200mm	10	100	1000
SGS63100 TT50	单头梅花带孔批头100mm	8	80	800	SGS63200 TT25	单头梅花带孔批头200mm	10	100	1000
SGS63110 TT10	单头梅花带孔批头110mm	10	100	1000	SGS63200 TT27	单头梅花带孔批头200mm	10	100	1000
SGS63110 TT15	单头梅花带孔批头110mm	10	100	1000	SGS63200 TT30	单头梅花带孔批头200mm	10	100	1000
SGS63110 TT20	单头梅花带孔批头110mm	10	100	1000	SGS63200 TT40	单头梅花带孔批头200mm	10	100	1000

单头内六角



受力面积更大，能够更好地分散力量
适用于受力较大的场合

The force area is larger, the force can be better dispersed
and it is suitable for occasions with large forces



货号命名规则

ITEM NUMBER NAMING RULES

SGS	63	50	H3.0
↓	↓	↓	↓
品牌名称	驱动杆径	批头长度	头型尺寸
BRAND NAME	Drive Rod Diameter	Batch head length	Head size

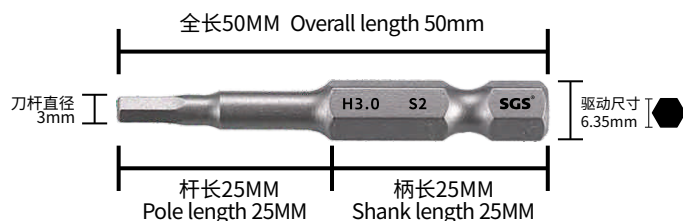

**我们制造高标准批头，
种类全面，满足所有工业及手工业领域的需求。**

We make high standard bits,
A comprehensive range to meet the needs of all industrial and handicraft fields



■ 6.35mm系列内六角螺丝批头 1/4" Hexagon Driver Hex Screw bits

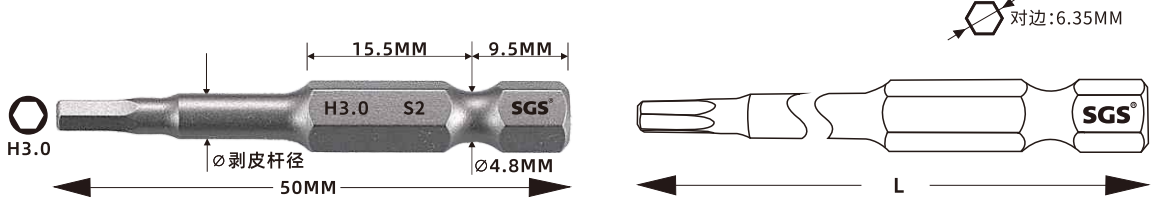

单头内六角



- 高端进口S2材质 .High-end imported S2 material
- 特殊热处理工艺, HRC61±1度 .Special heat treatment process, HRC61±1 degree
- 表面本色喷砂处理(可做其他表面处理:精抛, 黑磷化等) .Sandblasted surface (Others are available: Fine polishing, black phosphating, etc.)

订货号/Item No	品名/Product Name				订货号/Item No	品名/Product Name			
SGS6325 H1.5	单头内六角批头25mm	20	400	4000	SGS6365 H7.0	单头内六角批头65mm	10	200	2000
SGS6325 H2.0	单头内六角批头25mm	20	400	4000	SGS6365 H8.0	单头内六角批头65mm	10	100	1000
SGS6325 H2.5	单头内六角批头25mm	20	400	4000	SGS6365 H10.0	单头内六角批头65mm	10	100	1000
SGS6325 H3.0	单头内六角批头25mm	20	400	4000	SGS6365 H12.0	单头内六角批头65mm	10	80	800
SGS6325 H4.0	单头内六角批头25mm	20	400	4000	SGS6375 H1.5	单头内六角批头75mm	10	100	1000
SGS6325 H5.0	单头内六角批头25mm	20	400	4000	SGS6375 H2.0	单头内六角批头75mm	10	100	1000
SGS6325 H6.0	单头内六角批头25mm	20	400	4000	SGS6375 H2.5	单头内六角批头75mm	10	100	1000
SGS6350 H1.5	单头内六角批头50mm	10	200	2000	SGS6375 H3.0	单头内六角批头75mm	10	100	1000
SGS6350 H2.0	单头内六角批头50mm	10	200	2000	SGS6375 H3.5	单头内六角批头75mm	10	100	1000
SGS6350 H2.5	单头内六角批头50mm	10	200	2000	SGS6375 H4.0	单头内六角批头75mm	10	100	1000
SGS6350 H3.0	单头内六角批头50mm	10	200	2000	SGS6375 H5.0	单头内六角批头75mm	10	100	1000
SGS6350 H3.5	单头内六角批头50mm	10	200	2000	SGS6375 H6.0	单头内六角批头75mm	10	100	1000
SGS6350 H4.0	单头内六角批头50mm	10	200	2000	SGS6375 H8.0	单头内六角批头75mm	5	50	500
SGS6350 H5.0	单头内六角批头50mm	10	200	2000	SGS6375 H10.0	单头内六角批头75mm	10	100	1000
SGS6350 H6.0	单头内六角批头50mm	10	200	2000	SGS6375 H12.0	单头内六角批头75mm	4	40	400
SGS6350 H8.0	单头内六角批头50mm	10	100	1000	SGS6380 H1.5	单头内六角批头80mm	10	100	1000
SGS6350 H10.0	单头内六角批头50mm	10	100	1000	SGS6380 H2.0	单头内六角批头80mm	10	100	1000
SGS6350 H12.0	单头内六角批头50mm	10	80	800	SGS6380 H2.5	单头内六角批头80mm	10	100	1000
SGS6365 H1.5	单头内六角批头65mm	10	200	2000	SGS6380 H3.0	单头内六角批头80mm	10	100	1000
SGS6365 H2.0	单头内六角批头65mm	10	200	2000	SGS6380 H4.0	单头内六角批头80mm	10	100	1000
SGS6365 H2.5	单头内六角批头65mm	10	200	2000	SGS6380 H5.0	单头内六角批头80mm	10	100	1000
SGS6365 H3.0	单头内六角批头65mm	10	200	2000	SGS6380 H6.0	单头内六角批头80mm	10	100	1000
SGS6365 H4.0	单头内六角批头65mm	10	200	2000	SGS6380 H8.0	单头内六角批头80mm	10	100	1000
SGS6365 H5.0	单头内六角批头65mm	10	200	2000	SGS6380 H10.0	单头内六角批头80mm	6	54	540
SGS6365 H6.0	单头内六角批头65mm	10	200	2000	SGS6380 H12.0	单头内六角批头80mm	4	40	400

我们制造高标准批头，
种类全面，满足所有工业及手工业领域的需求。

We make high standard bits,
A comprehensive range to meet the needs of all industrial and handicraft fields



6.35mm系列内六角螺丝批头 1/4" Hexagon Driver Hex Screw bits

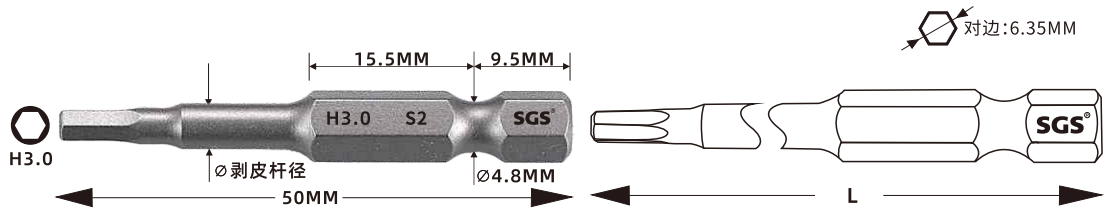

单头内六角

- 高端进口S2材质 .High-end imported S2 material
- 特殊热处理工艺, HRC61±1度 .Special heat treatment process, HRC61±1 degree
- 表面本色喷砂处理(可做其他表面处理: 精抛, 黑磷化等) .Sandblasted surface (Others are available: Fine polishing, black phosphating, etc.)

订货号/Item No	品名/Product Name				订货号/Item No	品名/Product Name			
SGS63100 H1.5	单头内六角批头100mm	10	100	1000	SGS63150 H2.0	单头内六角批头150mm	10	100	1000
SGS63100 H2.0	单头内六角批头100mm	10	100	1000	SGS63150 H2.5	单头内六角批头150mm	10	100	1000
SGS63100 H2.5	单头内六角批头100mm	10	100	1000	SGS63150 H3.0	单头内六角批头150mm	10	100	1000
SGS63100 H3.0	单头内六角批头100mm	10	100	1000	SGS63150 H4.0	单头内六角批头150mm	10	100	1000
SGS63100 H3.5	单头内六角批头100mm	10	100	1000	SGS63150 H5.0	单头内六角批头150mm	10	100	1000
SGS63100 H4.0	单头内六角批头100mm	10	100	1000	SGS63150 H6.0	单头内六角批头150mm	10	100	1000
SGS63100 H4.5	单头内六角批头100mm	10	100	1000	SGS63150 H8.0	单头内六角批头150mm	8	80	800
SGS63100 H5.0	单头内六角批头100mm	10	100	1000	SGS63150 H10.0	单头内六角批头150mm	6	54	540
SGS63100 H5.5	单头内六角批头100mm	10	100	1000	SGS63150 H12.0	单头内六角批头150mm	5	40	400
SGS63100 H6.0	单头内六角批头100mm	10	100	1000	SGS63200 H1.5	单头内六角批头200mm	10	100	1000
SGS63100 H8.0	单头内六角批头100mm	8	80	800	SGS63200 H2.0	单头内六角批头200mm	10	100	1000
SGS63100 H10.0	单头内六角批头100mm	6	60	600	SGS63200 H2.5	单头内六角批头200mm	10	100	1000
SGS63100 H12.0	单头内六角批头100mm	4	40	400	SGS63200 H3.0	单头内六角批头200mm	10	100	1000
SGS63110 H1.5	单头内六角批头110mm	10	100	1000	SGS63200 H4.0	单头内六角批头200mm	10	100	1000
SGS63110 H2.0	单头内六角批头110mm	10	100	1000	SGS63200 H5.0	单头内六角批头200mm	10	100	1000
SGS63110 H2.5	单头内六角批头110mm	10	100	1000	SGS63200 H6.0	单头内六角批头200mm	10	100	1000
SGS63110 H3.0	单头内六角批头110mm	10	100	1000	SGS63200 H8.0	单头内六角批头200mm	8	80	800
SGS63110 H4.0	单头内六角批头110mm	10	100	1000	SGS63200 H10.0	单头内六角批头200mm	6	54	540
SGS63110 H5.0	单头内六角批头110mm	10	100	1000	SGS63200 H12.0	单头内六角批头200mm	5	40	400
SGS63110 H6.0	单头内六角批头110mm	10	100	1000	SGS63250 H12.0	单头内六角批头250mm	4	40	400
SGS63110 H8.0	单头内六角批头110mm	8	80	800	SGS63300 H3.0	单头内六角批头300mm	5	50	500
SGS63110 H10.0	单头内六角批头110mm	6	60	600	SGS63300 H4.0	单头内六角批头300mm	5	50	500
SGS63110 H12.0	单头内六角批头110mm	5	40	400	SGS63300 H5.0	单头内六角批头300mm	5	50	500
SGS63150 H1.5	单头内六角批头150mm	10	100	1000	SGS63300 H6.0	单头内六角批头300mm	5	50	500

Ball Head Screw Bits

球头批头

可倾斜26°的球头设计
适合用于空间限制的作业

The design can be tilted to
26 degrees, which is suitable for work with
space constraints



货号命名规则

ITEM NUMBER NAMING RULES

SGS	63	65	QT4.0
⋮	⋮	⋮	⋮
品牌名称	驱动杆径	批头长度	头型尺寸
BRAND NAME	Drive Rod Diameter	Batch head length	Head size

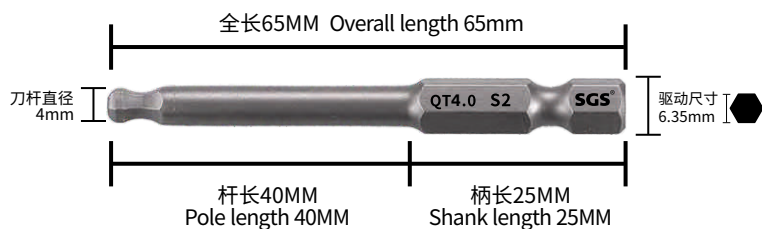



**我们制造高标准批头，
种类全面，满足所有工业及手工业领域的需求。**

We make high standard bits,
A comprehensive range to meet the needs of all industrial and handicraft fields

■ 6.35mm系列球头批头 1/4" Hexagon Driver Ball Head Screw bits

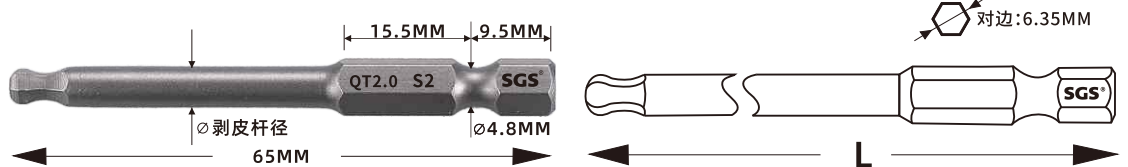

单头球头



- 高端进口S2材质
- 特殊热处理工艺, HRC61±1度
- 表面本色喷砂处理(可做其他表面处理: 精抛, 黑磷化等)

- High-end imported S2 material
- Special heat treatment process, HRC61±1 degree
- Sandblasted surface (Others are available: Fine polishing, black phosphating, etc.)

订货号/Item No	品名 Product Name	∅ 杆径				订货号/Item No	品名 Product Name	∅ 杆径			
SGS6365 QT2.0	单头球形批头65mm	3mm	10	200	2000	SGS63100 QT2.0	单头球形批头100mm	3mm	10	100	1000
SGS6365 QT2.5	单头球形批头65mm	3.5mm	10	200	2000	SGS63100 QT2.5	单头球形批头100mm	3.5mm	10	100	1000
SGS6365 QT3.0	单头球形批头65mm	4mm	10	200	2000	SGS63100 QT3.0	单头球形批头100mm	4mm	10	100	1000
SGS6365 QT4.0	单头球形批头65mm	5mm	10	200	2000	SGS63100 QT4.0	单头球形批头100mm	5mm	10	100	1000
SGS6365 QT5.0	单头球形批头65mm	6mm	10	200	2000	SGS63100 QT5.0	单头球形批头100mm	6mm	10	100	1000
SGS6365 QT6.0	单头球形批头65mm	6.35mm	10	200	2000	SGS63100 QT6.0	单头球形批头100mm	6.35mm	10	100	1000
SGS6365 QT8.0	单头球形批头65mm	8mm	10	200	2000	SGS63100 QT8.0	单头球形批头100mm	8mm	8	80	800
SGS6365 QT10.0	单头球形批头65mm	10mm	10	200	2000	SGS63100 QT10.0	单头球形批头100mm	10mm	6	60	600
SGS6365 QT12.0	单头球形批头65mm	12mm	10	80	800	SGS63100 QT12.0	单头球形批头100mm	12mm	4	40	400
SGS6375 QT2.0	单头球形批头75mm	3mm	10	100	1000	SGS63150 QT2.0	单头球形批头150mm	3mm	10	100	1000
SGS6375 QT2.5	单头球形批头75mm	3.5mm	10	100	1000	SGS63150 QT2.5	单头球形批头150mm	3.5mm	10	100	1000
SGS6375 QT3.0	单头球形批头75mm	4mm	10	100	1000	SGS63150 QT3.0	单头球形批头150mm	4mm	10	100	1000
SGS6375 QT4.0	单头球形批头75mm	5mm	10	100	1000	SGS63150 QT4.0	单头球形批头150mm	5mm	10	100	1000
SGS6375 QT5.0	单头球形批头75mm	6mm	10	100	1000	SGS63150 QT5.0	单头球形批头150mm	6mm	10	100	1000
SGS6375 QT6.0	单头球形批头75mm	6.35mm	10	100	1000	SGS63150 QT6.0	单头球形批头150mm	6.35mm	10	100	1000
SGS6375 QT8.0	单头球形批头75mm	8mm	5	50	500	SGS63150 QT8.0	单头球形批头150mm	8mm	8	80	800
SGS6375 QT10.0	单头球形批头75mm	10mm	10	100	1000	SGS63150 QT10.0	单头球形批头150mm	10mm	6	54	540
SGS6375 QT12.0	单头球形批头75mm	12mm	4	40	400	SGS63150 QT12.0	单头球形批头150mm	12mm	5	40	400

Single Square Screw Bits

单头方形批头

通用性、实用性、适应性和强劲的性能成为许多用户首选的工具之一

Versatility, practicality, adaptability and strong performance have become one of the preferred tools for many users



货号命名规则

ITEM NUMBER NAMING RULES

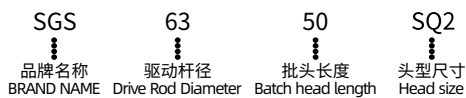

方形批头头部尺寸

SQUARE LOT HEAD SIZE

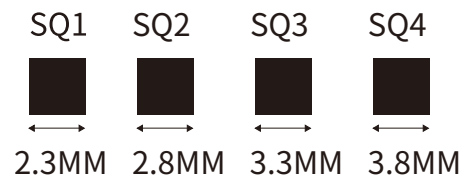
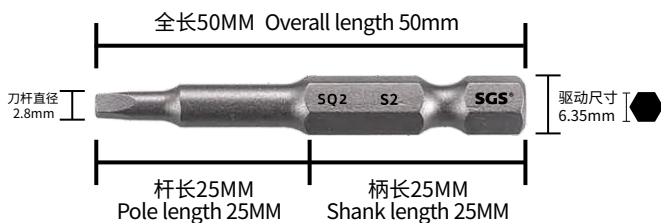

我们制造高标准批头，
种类全面，满足所有工业及手工业领域的需求。

We make high standard bits,
A comprehensive range to meet the needs of all industrial and handicraft fields



■ 6.35mm系列方形批头 1/4" Hexagon Driver Squarer Screw bits

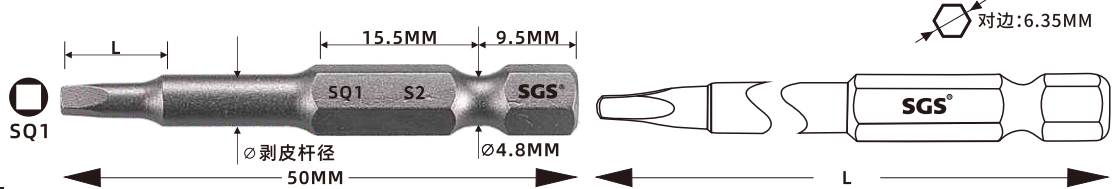

单头方形



- 高端进口S2材质 .High-end imported S2 material
- 特殊热处理工艺, HRC61±1度 .Special heat treatment process, HRC61±1 degree
- 表面本色喷砂处理(可做其他表面处理: 精抛, 黑磷化等) .Sandblasted surface (Others are available: Fine polishing, black phosphating, etc.)

订货号/Item No	品名/Product Name	剥皮杆径/Rod Diameter	支/PCS	支/PCS	支/PCS
SGS6325 SQ0	单头方型批头25mm	/	20	400	4000
SGS6325 SQ1	单头方型批头25mm	/	20	400	4000
SGS6325 SQ2	单头方型批头25mm	/	20	400	4000
SGS6325 SQ3	单头方型批头25mm	/	20	400	4000
SGS6325 SQ4	单头方型批头25mm	/	20	400	4000
SGS6350 SQ1	单头方形批头50mm	5.0mm	10	200	2000
SGS6350 SQ2	单头方形批头50mm	5.5mm	10	200	2000
SGS6350 SQ3	单头方形批头50mm	6.0mm	10	200	2000
SGS6350 SQ4	单头方形批头50mm	6.35mm	10	200	2000
SGS6375 SQ1	单头方形批头75mm	5.0mm	10	100	1000
SGS6375 SQ2	单头方形批头75mm	5.5mm	10	100	1000
SGS6375 SQ3	单头方形批头75mm	6.0mm	10	100	1000
SGS6375 SQ4	单头方形批头75mm	6.35mm	10	100	1000
SGS63100 SQ1	单头方形批头100mm	5.0mm	10	100	1000
SGS63100 SQ2	单头方形批头100mm	5.5mm	10	100	1000
SGS63100 SQ3	单头方形批头100mm	6.0mm	10	100	1000
SGS63100 SQ4	单头方形批头100mm	6.35mm	10	100	1000
SGS63150 SQ1	单头方形批头150mm	5.0mm	10	100	1000
SGS63150 SQ2	单头方形批头150mm	5.5mm	10	100	1000
SGS63150 SQ3	单头方形批头150mm	6.0mm	10	100	1000
SGS63150 SQ4	单头方形批头150mm	6.35mm	10	100	1000

SINGLE HEAD
U,Y,TA BITS

单头Y,U,TA批头

告别空转同心度高
No idling, high concentricity



宽: 1.7mm U1.7
宽: 2.0mm U2.0
宽: 2.3mm U2.3
宽: 2.6mm U2.6



外径: 3.0mm Y3
外径: 4.0mm Y4
外径: 5.0mm Y5
外径: 6.0mm Y6



高: 1.8mm TA18
高: 2.0mm TA20
高: 2.3mm TA23
高: 2.6mm TA26
高: 3.0mm TA30

相匹配螺丝
MATCHING SCREWS



我们制造高标准批头，
种类全面，满足所有工业及手工业领域的需求。

We make high standard bits,
A comprehensive range to meet the needs of all industrial and handicraft fields



■ 6.35mm系列U型批头 1/4" Hexagon Driver Ushape Screw bits



单头U型

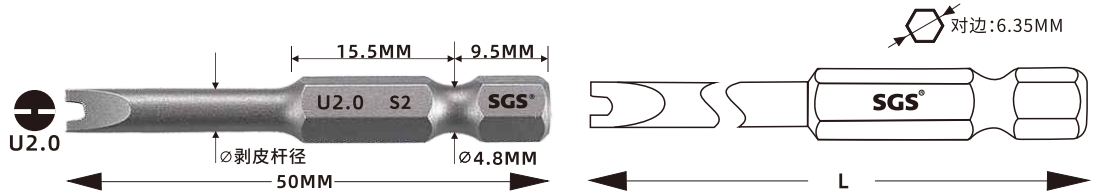

订货号/Item No	品名/Product Name	剥皮杆径/Rod Diameter	支/PCS	支/PCS	支/PCS
SGS6325 U1.7	单头U型批头25mm	/	20	400	4000
SGS6325 U2.0	单头U型批头25mm	/	20	400	4000
SGS6325 U2.3	单头U型批头25mm	/	20	400	4000
SGS6325 U2.6	单头U型批头25mm	/	20	400	4000
SGS6350 U1.7	单头U型批头50mm	4.0mm	10	200	2000
SGS6350 U2.0	单头U型批头50mm	4.5mm	10	200	2000
SGS6350 U2.3	单头U型批头50mm	4.0mm	10	200	2000
SGS6350 U2.6	单头U型批头50mm	4.0mm	10	200	2000
SGS6375 U1.7	单头U型批头75mm	4.0mm	10	200	2000
SGS6375 U2.0	单头U型批头75mm	4.5mm	10	200	2000
SGS6375 U2.3	单头U型批头75mm	4.0mm	10	200	2000
SGS6375 U2.6	单头U型批头75mm	4.0mm	10	200	2000

■ 6.35mm系列三角型螺丝批头 1/4" Hexagon Driver Triangle Screw bits



单头三角

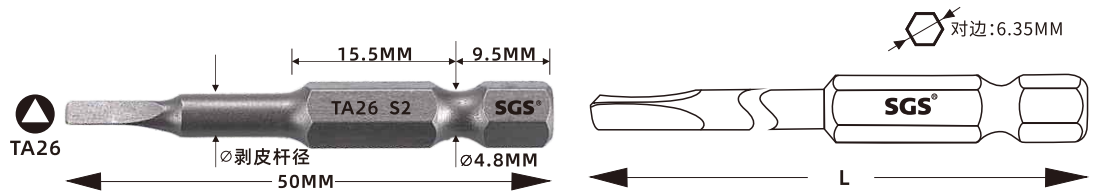

订货号/Item No	品名/Product Name	剥皮杆径/Rod Diameter	支/PCS	支/PCS	支/PCS
SGS6325 TA18	单头三角批头25mm	/	20	400	4000
SGS6325 TA20	单头三角批头25mm	/	20	400	4000
SGS6325 TA23	单头三角批头25mm	/	20	400	4000
SGS6325 TA26	单头三角批头25mm	/	20	400	4000
SGS6325 TA30	单头三角批头25mm	/	20	400	4000
SGS6350 TA18	单头三角批头50mm	3.5mm	10	200	2000
SGS6350 TA20	单头三角批头50mm	4.0mm	10	200	2000
SGS6350 TA23	单头三角批头50mm	4.5mm	10	200	2000
SGS6350 TA26	单头三角批头50mm	5.0mm	10	200	2000
SGS6350 TA30	单头三角批头50mm	6.0mm	10	200	2000
SGS6375 TA18	单头三角批头75mm	3.5mm	10	200	2000
SGS6375 TA20	单头三角批头75mm	4.0mm	10	200	2000
SGS6375 TA23	单头三角批头75mm	4.5mm	10	200	2000
SGS6375 TA26	单头三角批头75mm	5.0mm	10	200	2000
SGS6375 TA30	单头三角批头75mm	6.0mm	10	200	2000

■ 6.35mm系列Y型螺丝批头 1/4" Hexagon Driver Y Shape Screw bits



单头Y型

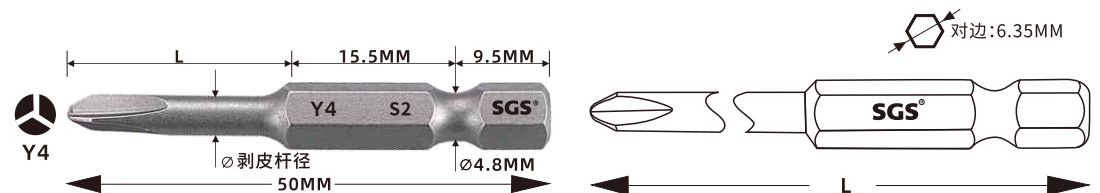

订货号/Item No	品名/Product Name	剥皮杆径/Rod Diameter	支/PCS	支/PCS	支/PCS
SGS6325 Y3	单头Y型批头25mm	/	20	400	4000
SGS6325 Y4	单头Y型批头25mm	/	20	400	4000
SGS6325 Y5	单头Y型批头25mm	/	20	400	4000
SGS6325 Y6	单头Y型批头25mm	/	20	400	4000
SGS6350 Y3	单头Y型批头50mm	4.0mm	10	200	2000
SGS6350 Y4	单头Y型批头50mm	4.5mm	10	200	2000
SGS6350 Y5	单头Y型批头50mm	5.5mm	10	200	2000
SGS6350 Y6	单头Y型批头50mm	6.0mm	10	200	2000
SGS6375 Y3	单头Y型批头50mm	4.0mm	10	100	1000
SGS6375 Y4	单头Y型批头50mm	4.5mm	10	100	1000
SGS6375 Y5	单头Y型批头50mm	5.5mm	10	100	1000
SGS6375 Y6	单头Y型批头50mm	6.0mm	10	100	1000

Torq Bits

万字批头

精确的头部设计，
多用于航空行业

Accurate head design specially for
the aviation industry



我们制造高标准批头，
种类全面，满足所有工业及手工业领域的需求。

We make high standard bits,
A comprehensive range to meet the needs of all industrial and handicraft fields



■ 万字头批头(S2材料) Torq Type Bits(S2 material)



万字头型



TS8

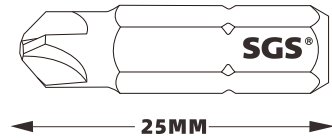
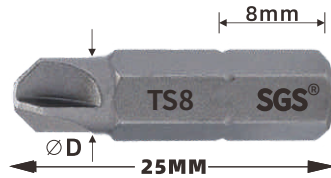

订货号/Item No	品名/Product Name	支/PCS	支/PCS	支/PCS
SGS6325 TS0	万字批头25mm	20	400	4000
SGS6325 TS1	万字批头25mm	20	400	4000
SGS6325 TS2	万字批头25mm	20	400	4000
SGS6325 TS3	万字批头25mm	20	400	4000
SGS6325 TS4	万字批头25mm	20	400	4000
SGS6325 TS5	万字批头25mm	20	400	4000
SGS6325 TS6	万字批头25mm	20	400	4000
SGS6325 TS8	万字批头25mm	20	400	4000
SGS6325 TS9	万字批头25mm	20	400	4000
SGS6325 TS10	万字批头25mm	20	400	4000
SGS6332 TS2	万字批头32mm	10	200	2000
SGS6332 TS4	万字批头32mm	10	200	2000
SGS6332 TS6	万字批头32mm	10	200	2000
SGS6332 TS8	万字批头32mm	10	200	2000
SGS6332 TS10	万字批头32mm	10	200	2000
SGS6332 TS1/4	万字批头32mm	10	200	2000
SGS6332 TS3/8	万字批头32mm	10	200	2000
SGS6332 TS5/16	万字批头32mm	10	200	2000

我们制造高标准批头，
种类全面，满足所有工业及手工业领域的需求。

We make high standard bits,
A comprehensive range to meet the needs of all industrial and handicraft fields



8mm系列十字冲击批 (S2材料) 8mm Series Phillips Impact Power Bits

8mm十字冲击批

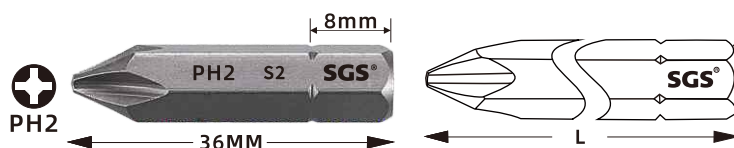

订货号/Item No	品名/Product Name	支/PCS	支/PCS	支/PCS
SGS8036 PH2	8mm十字冲击批	20	200	2000
SGS8036 PH3	8mm十字冲击批	20	200	2000
SGS8080 PH2	8mm十字冲击批	10	100	1000
SGS8080 PH3	8mm十字冲击批	10	100	1000
SGS8080 PH4	8mm十字冲击批	10	100	1000

8mm系列一字冲击批 (S2材料) 8mm Series Slotted Impact Power Bits

8mm一字冲击批

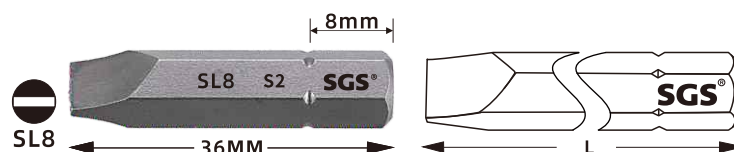

订货号/Item No	品名/Product Name	支/PCS	支/PCS	支/PCS
SGS8036 SL8.0	8mm一字冲击批	20	200	2000
SGS8080 SL8.0	8mm一字冲击批	10	100	1000

8mm系列梅花冲击批 (S2材料) 8mm Series Torx Impact Power Bits

8mm梅花冲击批

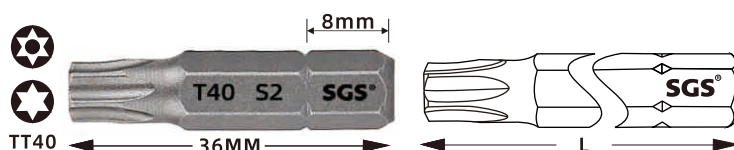

订货号/Item No	品名/Product Name	支/PCS	支/PCS	支/PCS
SGS8036 T30	8mm梅花冲击批	20	200	2000
SGS8036 T40	8mm梅花冲击批	20	200	2000
SGS8036 T50	8mm梅花冲击批	20	200	2000
SGS8080 T30	8mm梅花冲击批	10	100	1000
SGS8080 T40	8mm梅花冲击批	10	100	1000
SGS8080 T50	8mm梅花冲击批	10	100	1000

8mm系列内六角冲击批 (S2材料) 8mm Series Hexagon Impact Power Bit

8mm内六角冲击批

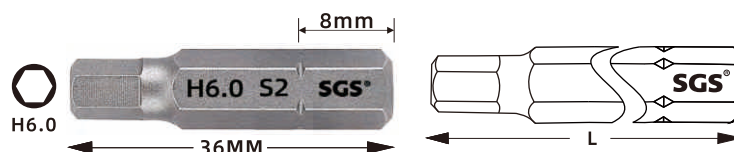

订货号/Item No	品名/Product Name	支/PCS	支/PCS	支/PCS
SGS8036 H5.0	8mm内六角冲击批	20	200	2000
SGS8036 H6.0	8mm内六角冲击批	20	200	2000
SGS8036 H8.0	8mm内六角冲击批	20	200	2000
SGS8080 H5.0	8mm内六角冲击批	10	100	1000
SGS8080 H6.0	8mm内六角冲击批	10	100	1000
SGS8080 H8.0	8mm内六角冲击批	10	100	1000

Electric Bits

电动批头

强磁处理 / 轻松吸附 / 便于拆卸更高效

STRONG MAGNETIC TREATMENT/EASY ADSORPTION/
EASY DISASSEMBLY MORE EFFICIENT/

高频淬火处理 / 韧性好硬度高

HIGH FREQUENCY QUENCHING TREATMENT/
GOOD TOUGHNESS AND HIGH HARDNESS



电批货号命名规则

Rules for naming electrical lot numbers

SGS

品牌名称
brand name

6

驱动杆径
Drive Rod Diameter

60

批头长度
Batch head length

5.0

剥皮杆径
peeling bar diameter

PH2

头型尺寸
Head size

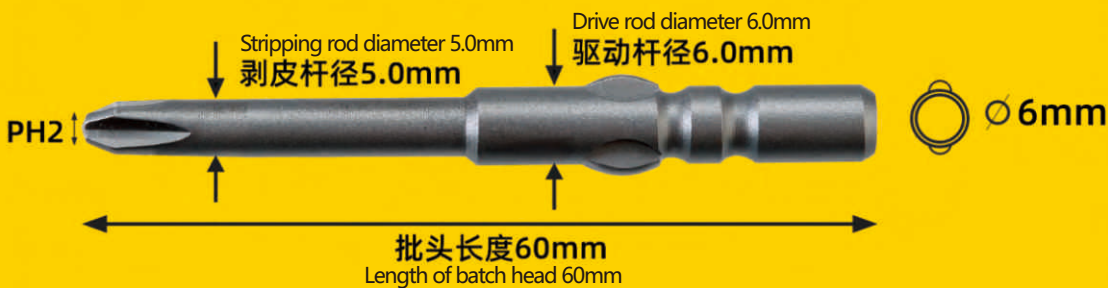

我们制造高标准批头，
种类全面，满足所有工业及手工业领域的需求。

We make high standard bits,
A comprehensive range to meet the needs of all industrial and handicraft fields



6mm系列十字型电动螺丝批头 6mm Series Phillips Electric Bits

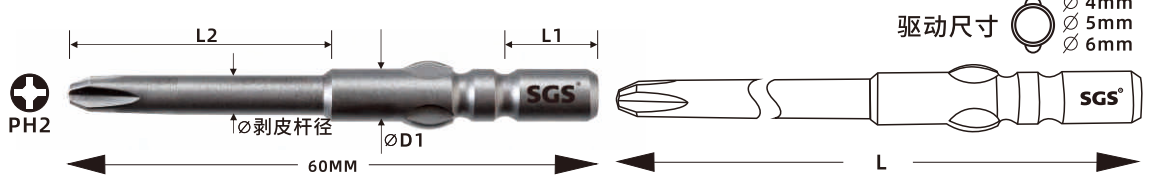
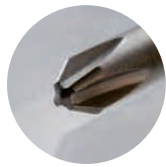

十字电批



- 高端进口S2材质 .High-end imported S2 material
- 特殊热处理工艺, HRC61±1度 .Special heat treatment process, HRC61±1 degree
- 表面本色喷砂处理 .Surface natural sandblasting
- 规格齐全 .Complete specifications
- 可定制其他颜色, 长度, 杆径, 头型及造型 .Other colors, lengths, rod diameters, head shapes and shapes can be customized

订货号/Item No	品名/Product Name	剥皮杆径/Rod Diameter	支/PCS	支/PCS	支/PCS
SGS660 1.6PH0	十字电批 60mm	1.6mm	10	200	2000
SGS660 1.8PH00	十字电批 60mm	1.8mm	10	200	2000
SGS660 2.0PH0	十字电批 60mm	2.0mm	10	200	2000
SGS660 2.5PH1	十字电批 60mm	2.5mm	10	200	2000
SGS660 3.0PH1	十字电批 60mm	3.0mm	10	200	2000
SGS660 3.5PH1	十字电批 60mm	3.5mm	10	200	2000
SGS660 4.0PH2	十字电批 60mm	4.0mm	10	200	2000
SGS660 4.5PH1	十字电批 60mm	4.5mm	10	200	2000
SGS660 5.0PH2	十字电批 60mm	5.0mm	10	200	2000
SGS660 6.0PH2	十字电批 60mm	6.0mm	10	200	2000
SGS680 3.0PH1	十字电批 80mm	3.0mm	10	100	1000
SGS680 3.5PH1	十字电批 80mm	3.5mm	10	100	1000
SGS680 4.0PH2	十字电批 80mm	4.0mm	10	100	1000
SGS680 5.0PH2	十字电批 80mm	5.0mm	10	100	1000
SGS680 6.0PH2	十字电批 80mm	6.0mm	10	100	1000
SGS6110 2.0PH1	十字电批 110mm	2.0mm	10	100	1000
SGS6110 2.5PH1	十字电批 110mm	2.5mm	10	100	1000
SGS6110 3.0PH1	十字电批 110mm	3.0mm	10	100	1000
SGS6110 3.5PH1	十字电批 110mm	3.5mm	10	100	1000
SGS6110 4.0PH2	十字电批 110mm	4.0mm	10	100	1000
SGS6110 4.5PH2	十字电批 110mm	4.5mm	10	100	1000
SGS6110 5.0PH2	十字电批 110mm	5.0mm	10	100	1000
SGS6110 6.0PH2	十字电批 110mm	6.0mm	10	100	1000
SGS6120 6.0PH2	十字电批 120mm	6.0mm	10	100	1000
SGS6150 2.0PH1	十字电批 150mm	2.0mm	10	100	1000
SGS6150 2.5PH1	十字电批 150mm	2.5mm	10	100	1000
SGS6150 3.0PH1	十字电批 150mm	3.0mm	10	100	1000
SGS6150 3.5PH1	十字电批 150mm	3.5mm	10	100	1000
SGS6150 4.0PH2	十字电批 150mm	4.0mm	10	100	1000
SGS6150 4.5PH2	十字电批 150mm	4.5mm	10	100	1000
SGS6150 5.0PH2	十字电批 150mm	5.0mm	10	100	1000
SGS6150 6.0PH2	十字电批 150mm	6.0mm	10	100	1000

我们制造高标准批头，
种类全面，满足所有工业及手工业领域的需求。

We make high standard bits,
A comprehensive range to meet the needs of all industrial and handicraft fields



■ 6mm系列一字电动螺丝批头 6mm Series Slotted Electric Bits(6mm)



一字电批

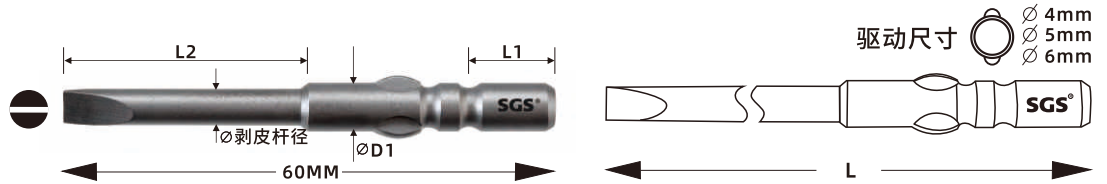

订货号/Item No	品名/Product Name	剥皮杆径/Rod Diameter	支/PCS	支/PCS	支/PCS
SGS660 SL1.5	一字电批 60mm	1.5mm	10	200	2000
SGS660 SL2.5	一字电批 60mm	2.5mm	10	200	2000
SGS660 SL3.0	一字电批 60mm	3.0mm	10	200	2000
SGS660 SL4.0	一字电批 60mm	4.0mm	10	200	2000
SGS660 SL5.0	一字电批 60mm	5.0mm	10	200	2000
SGS660 SL6.0	一字电批 60mm	6.0mm	10	200	2000

■ 6mm系列梅花带孔电动螺 丝批头6mm Series Torx With Holes Electric Bits (tamper-proof)



梅花电批

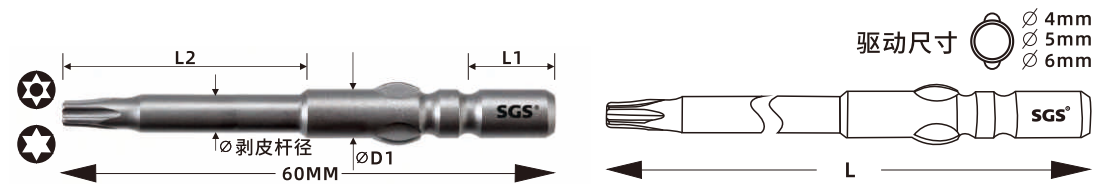

订货号/Item No	品名/Product Name	剥皮杆径/Rod Diameter	支/PCS	支/PCS	支/PCS
SGS660 T5	梅花电批 60mm	3.0mm	10	200	2000
SGS660 T6	梅花电批 60mm	3.0mm	10	200	2000
SGS660 T7	梅花电批 60mm	3.0mm	10	200	2000
SGS660 T8	梅花电批 60mm	3.5mm	10	200	2000
SGS660 T9	梅花电批 60mm	3.5mm	10	200	2000
SGS660 T10	梅花电批 60mm	4.0mm	10	200	2000
SGS660 T15	梅花电批 60mm	4.0mm	10	200	2000
SGS660 T20	梅花电批 60mm	4.5mm	10	200	2000
SGS660 T25	梅花电批 60mm	5.0mm	10	200	2000
SGS660 T30	梅花电批 60mm	6.0mm	10	200	2000

■ 6mm系列内六角电动螺丝批头 6mm Series Hex Electric Bits



内六角电批

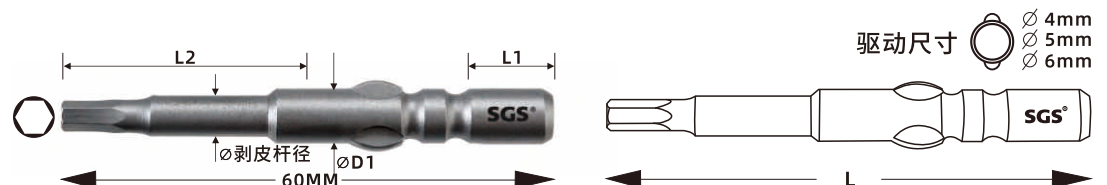

订货号/Item No	品名/Product Name	剥皮杆径/Rod Diameter	支/PCS	支/PCS	支/PCS
SGS660 H1.5	内六角电批 60mm	3.0mm	10	200	2000
SGS660 H2.0	内六角电批 60mm	3.5mm	10	200	2000
SGS660 H2.5	内六角电批 60mm	4.0mm	10	200	2000
SGS660 H3.0	内六角电批 60mm	4.5mm	10	200	2000
SGS660 H4.0	内六角电批 60mm	5.5mm	10	200	2000
SGS660 H5.0	内六角电批 60mm	6.0mm	10	200	2000
SGS660 H6.0	内六角电批 60mm	6.0mm	10	200	2000
SGS6110 H2.0	内六角电批 60mm	3.5mm	10	200	2000
SGS6110 H2.5	内六角电批 60mm	4.0mm	10	100	1000

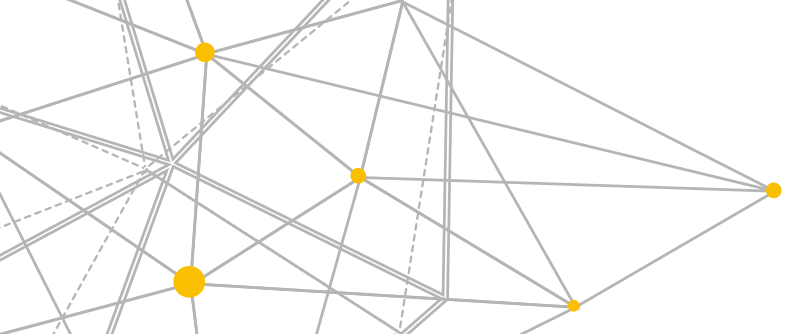

NUT SETTER

风批套筒 批头接杆

持久耐磨带强磁

Long-lasting wear-resistant with
strong magnetism



我们制造高标准批头，
种类全面，满足所有工业及手工业领域的需求。

We make high standard bits,
A comprehensive range to meet the needs of all industrial and handicraft fields



■ 6.35mm系列强磁风批套筒 1/4" Hexagon Driver Nut Setter With Strong Magnetic

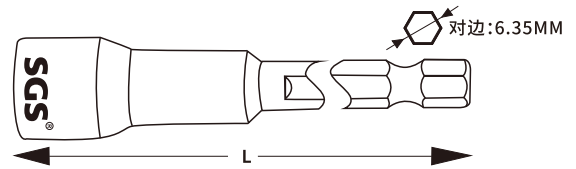

强磁风批套筒



- CRV材质
- 特殊热处理工艺, HRC54±1度
- 表面本色喷砂处理
- 规格齐全
- 可定制其他颜色, 长度, 杆径, 头型及造型

- .CRV material
- .Special heat treatment process, HRC54±1 degree
- .Surface natural sandblasting
- .Complete specifications
- .Other colors, lengths, rod diameters, head shapes and shapes can be customized

订货号/Item No	品名/Product Name	支/PCS	支/PCS	支/PCS
SGS6342 H8M	强磁风批套筒 42mm	10	100	1000
SGS6342 H10M	强磁风批套筒 42mm	10	100	1000
SGS6348 H6M	强磁风批套筒 48mm	10	100	1000
SGS6348 H8M	强磁风批套筒 48mm	10	100	1000
SGS6348 H10M	强磁风批套筒 48mm	10	100	1000
SGS6348 H12M	强磁风批套筒 48mm	10	100	1000
SGS6348 H13M	强磁风批套筒 48mm	10	100	1000
SGS6365 H6M	强磁风批套筒 65mm	10	100	1000
SGS6365 H7M	强磁风批套筒 65mm	10	100	1000
SGS6365 H8M	强磁风批套筒 65mm	10	100	1000
SGS6365 H9M	强磁风批套筒 65mm	8	80	800
SGS6365 H10M	强磁风批套筒 65mm	8	80	800
SGS6365 H11M	强磁风批套筒 65mm	8	80	800
SGS6365 H12M	强磁风批套筒 65mm	5	50	500
SGS6365 H13M	强磁风批套筒 65mm	5	50	500
SGS6365 H14M	强磁风批套筒 65mm	4	40	400
SGS6365 H15M	强磁风批套筒 65mm	3	30	300
SGS6365 H16M	强磁风批套筒 65mm	3	30	300
SGS6365 H17M	强磁风批套筒 65mm	3	30	300
SGS6365 H18M	强磁风批套筒 65mm	2	20	200
SGS6365 H19M	强磁风批套筒 65mm	2	20	200
SGS63100 H6M	强磁风批套筒 100mm	5	60	600
SGS63100 H7M	强磁风批套筒 100mm	5	50	500
SGS63100 H8M	强磁风批套筒 100mm	5	50	500
SGS63100 H9M	强磁风批套筒 100mm	5	40	400
SGS63100 H10M	强磁风批套筒 100mm	5	40	400
SGS63100 H11M	强磁风批套筒 100mm	5	35	350
SGS63100 H12M	强磁风批套筒 100mm	5	35	350
SGS63100 H13M	强磁风批套筒 100mm	5	30	300
SGS63100 H14M	强磁风批套筒 100mm	4	28	280
SGS63100 H15M	强磁风批套筒 100mm	4	24	240
SGS63100 H16M	强磁风批套筒 100mm	4	20	200
SGS63100 H17M	强磁风批套筒 100mm	4	20	200
SGS63100 H18M	强磁风批套筒 100mm	3	15	150
SGS63100 H19M	强磁风批套筒 100mm	3	15	150
SGS63150 H6M	强磁风批套筒 150mm	5	60	600
SGS63150 H7M	强磁风批套筒 150mm	5	50	500
SGS63150 H8M	强磁风批套筒 150mm	5	50	500
SGS63150 H9M	强磁风批套筒 150mm	5	40	400
SGS63150 H10M	强磁风批套筒 150mm	5	40	400
SGS63150 H11M	强磁风批套筒 150mm	5	50	500
SGS63150 H12M	强磁风批套筒 150mm	5	30	300
SGS63150 H13M	强磁风批套筒 150mm	5	30	300
SGS63150 H14M	强磁风批套筒 150mm	5	30	300
SGS63150 H15M	强磁风批套筒 150mm	4	20	200
SGS63150 H16M	强磁风批套筒 150mm	4	20	200
SGS63150 H17M	强磁风批套筒 150mm	4	20	200
SGS63150 H18M	强磁风批套筒 150mm	4	20	200
SGS63150 H19M	强磁风批套筒 150mm	4	16	160

我们制造高标准批头，
种类全面，满足所有工业及手工业领域的需求。

We make high standard bits,
A comprehensive range to meet the needs of all industrial and handicraft fields



■ 6.35mm系列加深风批套筒 1/4" Hexagon Driver Deepening Nut Setter With Magnetic



加深风批套筒

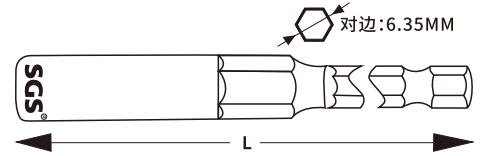

订货号/Item No	品名/Name	支/PCS	支/PCS	支/PCS
SGS6380 H6M	加深风批套筒 80mm	6	60	600
SGS6380 H7M	加深风批套筒 80mm	15	120	1200
SGS6380 H8M	加深风批套筒 80mm	15	120	1200
SGS6380 H9M	加深风批套筒 80mm	12	96	960
SGS6380 H10M	加深风批套筒 80mm	12	96	960
SGS6380 H11M	加深风批套筒 80mm	9	54	540
SGS6380 H12M	加深风批套筒 80mm	9	54	450
SGS6380 H13M	加深风批套筒 80mm	9	54	300
SGS6380 H14M	加深风批套筒 80mm	9	45	240
SGS6380 H15M	加深风批套筒 80mm	6	36	360
SGS6380 H16M	加深风批套筒 80mm	6	36	360
SGS6380 H17M	加深风批套筒 80mm	6	30	500
SGS6380 H18M	加深风批套筒 80mm	6	24	240
SGS6380 H19M	加深风批套筒 80mm	6	24	240

■ 一体套筒批头/ One-piece nut setter bit

梅花一体套筒批头



订货号/Item No	订货号/Item No
SGST25-MO	SGST50-MO
SGST27-MO	SGST52-MO
SGST30-MO	SGST60-MO
SGST40-MO	SGST70-MO
SGST45-MO	SGST80-MO

梅花12角一体套筒批头



订货号/Item No	订货号/Item No
SGSM5-MO	SGSM10-MO
SGSM6-MO	SGSM12-MO
SGSM7-MO	SGSM14-MO
SGSM8-MO	SGSM16-MO
SGSM9-MO	SGSM18-MO

内六角一体套筒批头





订货号/Item No	订货号/Item No
SGSH5-MO	SGSH12-MO
SGSH6-MO	SGSH14-MO
SGSH7-MO	SGSH16-MO
SGSH8-MO	SGSH17-MO
SGSH10-MO	SGSH19-MO





我们制造高标准批头，
种类全面，满足所有工业及手工业领域的需求。

We make high standard bits,
A comprehensive range to meet the needs of all industrial and handicraft fields

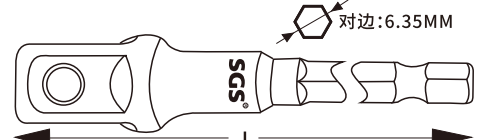

■ 6.35mm系列带珠接杆 1/4" Hexagon Driver Nut Setter With Bead

带珠接杆 		9.5mm		
	65MM		对边:6.35MM	
订货号/Item No	品名/Name	支/PCS	支/PCS	支/PCS
SGS6365 Q1/4	带珠接杆 65mm	10	100	1000
SGS6365 Q3/8	带珠接杆 65mm	10	100	1000
SGS6373 Q1/2	带珠接杆 73mm	10	80	800

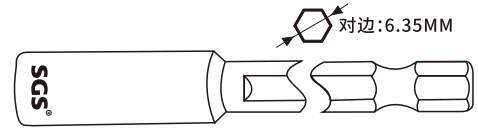

■ 6.35mm系列一体接杆 1/4" Hexagon Driver One-Piece Nut Setter

一体接杆 		9.5mm		
	60MM		对边:6.35MM	
订货号/Item No	品名/Product Name	支/PCS	支/PCS	支/PCS
SGS6360 H1/4(YT)	一体接杆 60mm	10	100	1000

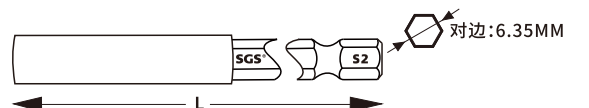
■ 6.35mm系列分体接杆 1/4" Hexagon Driver Split Nut Setter

不锈钢分体接杆 		9.5mm		
	60MM		对边:6.35MM	
订货号/Item No	品名/Name	支/PCS	支/PCS	支/PCS
SGS6360 H1/4(FT)	分体接杆 60mm	10	100	1000
SGS6375 H1/4(FT)	分体接杆 75mm	5	50	500
SGS63100 H1/4(FT)	分体接杆 100mm	5	50	500
SGS63150 H1/4(FT)	分体接杆 150mm	5	50	500

■ 6.35mm系列分体接杆黑磷化 1/4" Hexagon Driver Split Nut Setter (IB)

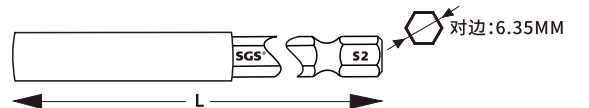
黑磷化分体接杆 		9.5mm		
	60MM		对边:6.35MM	
订货号/Item No	品名/Name	支/PCS	支/PCS	支/PCS
SGS6360 H1/4(FT)	分体接杆 60mm	10	100	1000
SGS6375 H1/4(FT)-IB	分体接杆 75mm	5	50	500
SGS63100 H1/4(FT)-IB	分体接杆 100mm	5	50	500
SGS63150 H1/4(FT)-IB	分体接杆 150mm	5	50	500

通用磁圈 SGS63005

磁圈均可定制不同颜色及不同款式

Universal magnetic ring SGS63005

Magnetic ring can be customized in different colors and styles

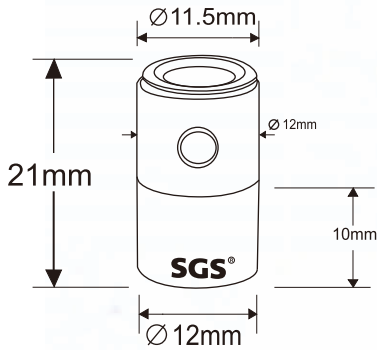

Straight concentricity

Effectively reduce slip and deviation

笔直同心度

有效减小打滑打偏现象



Universal magnetic ring SGS63001

Magnetic ring can be customized in different colors and styles

通用磁圈 SGS63001

磁圈均可定制不同颜色及不同款式





安装方法

Installation method



设计原理

Design principle

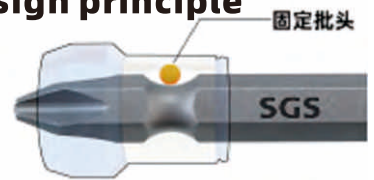

磁圈&批头链接稳固

不易掉落, 提高工作效率
可单手紧固螺丝, 适合高空作业

The link between magnetic ring and bits is stable

The link between magnetic ring and bits is stable

SGS63001包装

10支/盒;

SGS63005包装

20支/盒;



环保标识

产品严格遵循限制使用Pb(铅)、Cd(镉)、Hg(水银)、六价铬、PBB(多溴联苯)、PBDE(二溴联苯醚)的相关法律法规。

订货号/Item No	品名/Product Name	支/PCS	支/PCS	支/PCS
SGS63001	通用磁圈/Magnetic ring	10	100	1000
SGS63005	通用磁圈/Magnetic ring	20	200	2000

我们制造高标准批头，
种类全面，满足所有工业及手工业领域的需求。

We make high standard bits,
A comprehensive range to meet the needs of all industrial and handicraft fields

■ 快脱/ Quick-release

快脱KS-10060
Quick-release KS-10060



快脱KS-10072
Quick-release KS-10072



■ 棘轮扳手/ Ratchet wrench



包装展示 Packaging Display



加磁挂盒
Magnetic hanging box



常规透明盒
Conventional transparent box



PVC袋装
Opp bag



塑料挂盒
Plastic hanging box



宝得塑料盒
Baode Plasticbox



电批盒
Electric screwdriverbox



吸卡
Blister card



插卡
Insert card



插卡
Insert card



插卡
Insert card



收纳条+插卡
Storage strip+Blister card



吸卡
Blister card



双泡壳
Blister card



opp袋散装
opp bag in bulk



PVC袋
Pvc bag



罗马柱盒子
Roman column box

批头定制服务——精准满足您的每一个需求

Batch header customization service - precisely meet your every need



定制步骤与流程

Customization Steps and Processes



定制批头时的确认事项

提供螺丝样本
螺丝紧固状态: 树脂、薄板(T=mm) 攻丝、
机械螺丝Moxomm、木螺丝 ommxomm 有无螺丝胶等
螺丝紧固工具的厂商名称、型号、输出扭矩、结构
定制要求的事项: 螺丝匹配、刀头强度改善(磨损、
折损)、卡死改善.....



制作测试时的定制批头

交付期: 目标实际25个工作日出厂



测试品完成

使用螺丝或者三维测量仪器检查咬合情况

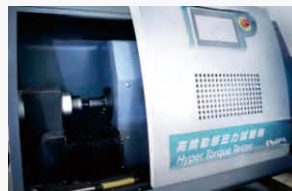

检测评估

运行成本
耐久度
其他(螺丝孔破损、产品变形情况)

表面处理展示

Surface treatment display

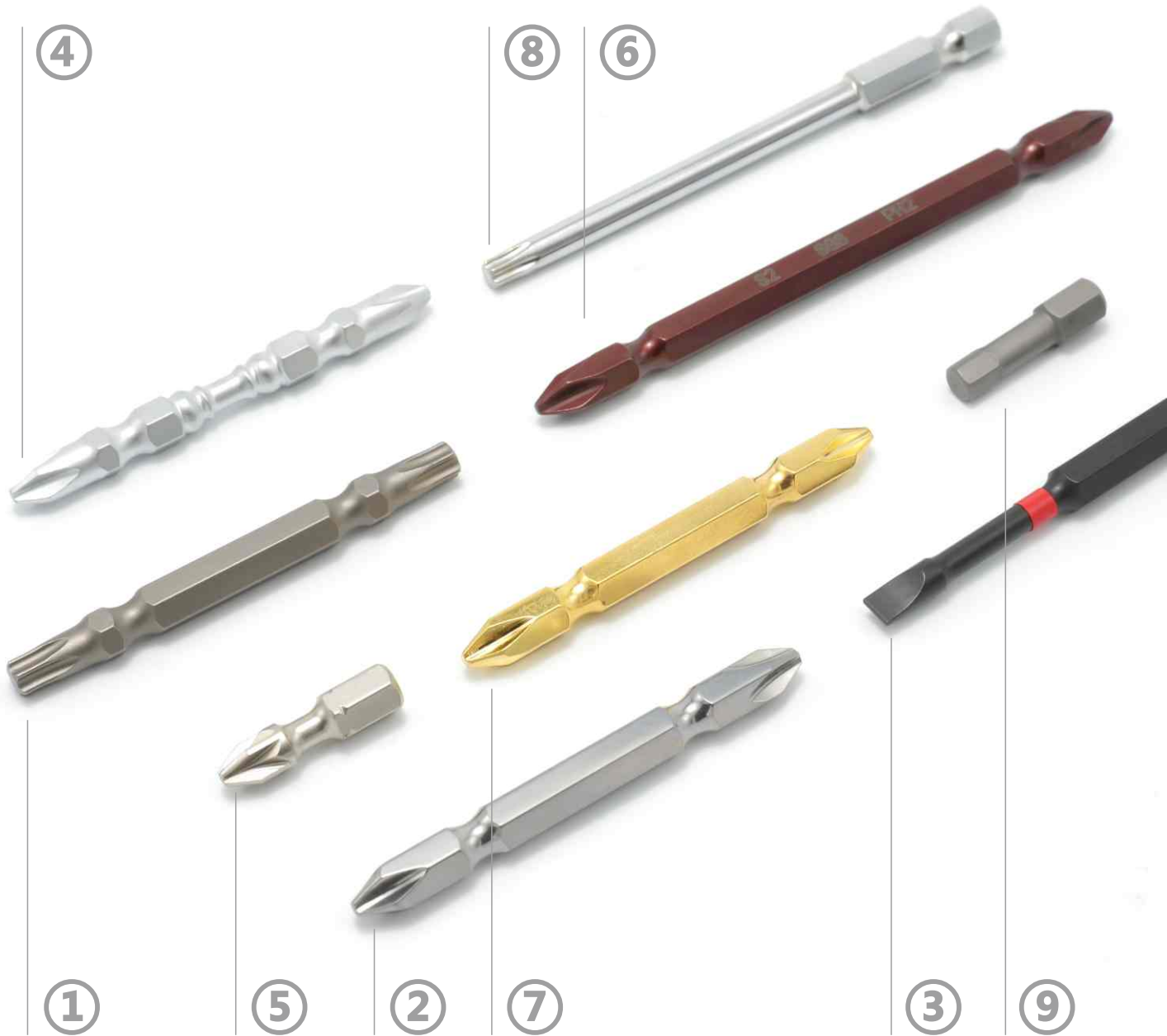

① 喷砂 Sand blasting

② 精抛 Fine polishing

③ 发黑 Black phosphating

④ 珍珠镍 Pearl nickel

⑤ 镀亮镍 Bright nickel plating

⑥ 发红 Red

⑦ 镀钛 Titanizing

⑧ 镀铬 Chromeplating

⑨ 灰磷化 Grey phosphating