

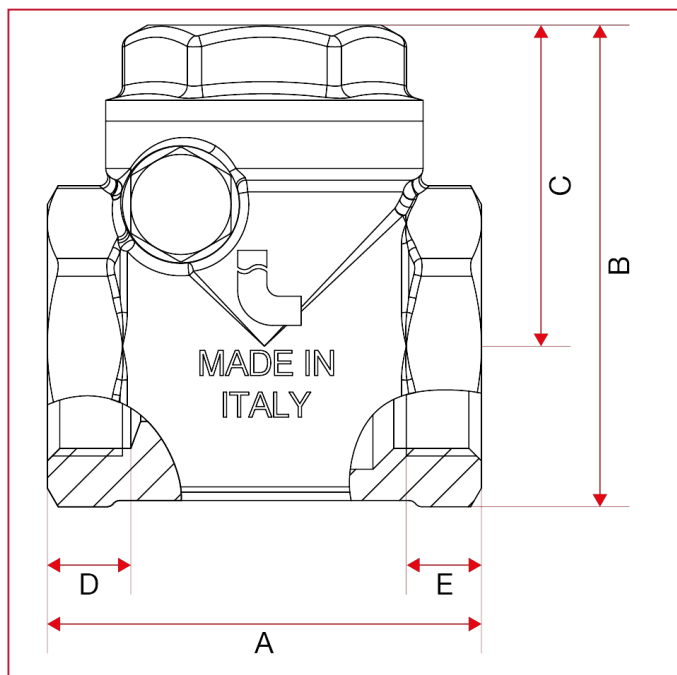

ГОРИЗОНТАЛЬНЫЙ ОБРАТНЫЙ КЛАПАН

130 Горизонтальный обратный клапан

ГАБАРИТНЫЕ РАЗМЕРЫ



130M

	3/8"	1/2"	3/4"	1"	1"1/4	1"1/2	2"	2"1/2	3"	4"
DN	10	15	20	25	32	40	50	65	80	100
A	43	43	52	62	72	81	94	119	134	169
B	50	50	58	66	76	86	100,2	126,7	146,5	183,5
C	35	35	38,5	42	47	54	61	78	90	111
D	12	9,5	10	13	13	13	13,5	20,5	22,5	30,5
E	8	8	9	11,5	11,5	14,5	13	18	20	24
Kg/cm ² bar	16	16	16	12	10	10	10	8	8	8
LBS - psi	232	232	232	174	145	145	145	116	116	116

130G

	3/8"	1/2"	3/4"	1"	1"1/4	1"1/2	2"
DN	10	15	20	25	32	40	50
A	43	43	52	62	72	81	94
B	50	50	58	66	76	86	100,2
C	35	35	38,5	42	47	54	61
D	12	9,5	10	13	13	13	13,5
E	8	8	9	11,5	11,5	14,5	13
Kg/cm ² bar	16	16	16	12	10	10	10
LBS - psi	232	232	232	174	145	145	145