

DE	Gebrauchsanleitung / Montageanleitung	2
FR	Mode d'emploi / Instructions de montage	3
EN	Instructions for use / assembly instructions	4
IT	Istruzioni per l'uso / Istruzioni per Installazione	5
ES	Modo de empleo / Instrucciones de montaje	6
NL	Gebruiksaanwijzing / Handleiding	7
DK	Brugsanvisning / Monteringsvejledning	8
PT	Instruções para uso / Manual de Instalação	9
PL	Instrukcja obsługi / Instrukcja montażu	10
CS	Návod k použití / Montážní návod	11
SK	Návod na použitie / Montážny návod	12
ZH	用户手册 / 组装说明	13
RU	Руководство пользователя / Инструкция по монтажу	14
FI	Käyttöohje / Asennusohje	15
SV	Bruksanvisning / Monteringsanvisning	16
LT	Vartotojo instrukcija / Montavimo instrukcijos	17
HR	Upute za uporabu / Uputstva za instalaciju	18
TR	Kullanım kılavuzu / Montaj kılavuzu	19
RO	Manual de utilizare / Instrucțiuni de montare	20
EL	Οδηγίες χρήσης / Οδηγία συναρμολόγησης	21
SI	Navodilo za uporabo / Navodila za montažo	22
ET	Kasutusjuhend / Paigaldusjuhend	23
LV	Lietošanas pamācība / Montāžas instrukcija	24
SR	Uputstvo za upotrebu / Uputstvo za montažu	25
NO	Bruksanvisning / Montasjeveiledning	26
BG	Инструкция за употреба / Ръководство за монтаж	27
SQ	Udhëzuesi i përdorimit / Udhëzime rreth montimit	28
AR	دليل الاستخدام / تعليمات التجميع	29
HU	Használati útmutató / Szerelési útmutató	30
JP	取扱説明書 / 施工説明書	31

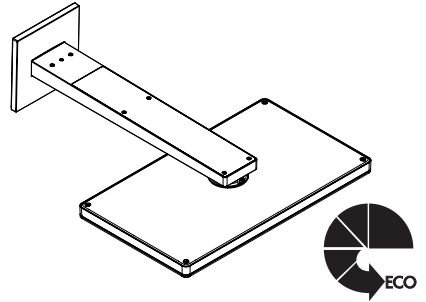

Rainmaker Select 460 2jet

2401540X

Rainmaker Select 460 3jet

2401740X



Sicherheitshinweise

- ⚠ Bei der Montage müssen zur Vermeidung von Quetsch- und Schnittverletzungen Handschuhe getragen werden.
- ⚠ Der Kopfbrausearm ist nur für das Halten der Kopfbrause ausgelegt, er darf nicht mit weiteren Gegenständen belastet werden!
- ⚠ Die Brause darf nur zur Bade-, Hygiene- und Körperreinigungszwecke eingesetzt werden.

Montagehinweise

- Vor der Montage muss das Produkt auf Transportschäden untersucht werden. Nach dem Einbau werden keine Transport- oder Oberflächenschäden anerkannt.
- Die Leitungen und die Armatur müssen nach den gültigen Normen montiert, gespült und geprüft werden.
- Die in den Ländern jeweils gültigen Installationsrichtlinien sind einzuhalten.
- Das Produkt ist nicht für die Verwendung in Verbindung mit einem Dampfbad vorgesehen!

Technische Daten

Betriebsdruck:	max. 0,6 MPa
Empfohlener Betriebsdruck:	0,3 - 0,4 MPa (1 MPa = 10 bar = 147 PSI)
Heißwassertemperatur:	max. 60 °C
Thermische Desinfektion:	max. 70 °C / 4 min

Dieses Produkt kann nicht in Verbindung mit hydraulisch und thermisch gesteuerten Durchlauferhitzern eingesetzt werden.

Das Produkt ist ausschließlich für Trinkwasser konzipiert!

Symbolerklärung



Kaltwasserseite



Warmwasser



In diesem Bereich ist eine Wandverstärkung notwendig.



Der nicht benötigte Abgang muss mit einem Blindstopfen abgedichtet werden.



Ablauf

Kein essigsäurehaltiges Silikon verwenden!



Maße (siehe Seite 37)



Durchflussdiagramm (siehe Seite 32)



Serviceteile (siehe Seite 42)

Sonderzubehör

nicht im Lieferumfang enthalten



Verlängerung 25 mm (siehe Seite 42)



Ausgleichsset 1° (siehe Seite 42)



Reinigung (siehe Seite 38)



Montagebeispiele (siehe Seite 32)

Störung

Kopfbrause stark undicht

Ursache

- Kopfbrause verschmutzt / verkalkt

Abhilfe

- Kopfbrause reinigen / entkalken
siehe Seite 38



Consignes de sécurité

- ⚠ Lors du montage, porter des gants de protection pour éviter toute blessure par écrasement ou coupure.
- ⚠ Le bras de la douche n'est conçu que pour tenir la douche et ne doit pas servir à la suspension d'autres objets !
- ⚠ La douche ne doit servir qu'à se doucher, à se nettoyer et à pratiquer une hygiène corporelle.

Instructions pour le montage

- Avant son montage, s'assurer que le produit n'a subi aucun dommage pendant le transport. Après le montage, tout dommage de transport ou de surface ne pourra pas être reconnu.
- Les conduites et la robinetterie doivent être montés, rincés et contrôlés selon les normes en vigueur.
- Les directives d'installation en vigueur dans le pays concerné doivent être respectées.
- Le produit n'est pas prévu pour une utilisation en liaison avec un bain à vapeur.







Informations techniques

Pression de service autorisée: max. 0,6 MPa
 Pression de service conseillée: 0,3 - 0,4 MPa
 (1 MPa = 10 bar = 147 PSI)
 Température d'eau chaude: max. 60 °C
 Désinfection thermique: max. 70 °C / 4 min

Les mitigeurs Hansgrohe ne doivent pas être utilisés avec des chauffe-eau instantanés à commande hydraulique ou thermique.

Le produit est exclusivement conçu pour de l'eau potable!

Description du symbole

-  eau froide
-  Eau chaude
-  Le mur n'a pas besoin d'être renforcé à cet endroit
-  La sortie non utilisée doit être condamnée avec un bouchon laiton.
-  Vidage
-  Ne pas utiliser de silicone contenant de l'acide acétique!

Dimensions (voir pages 37)

Diagramme du débit (voir pages 32)

Pièces détachées (voir pages 42)

Accessoires en option

ne fait pas partie de la fourniture

jeu de rallonge 25 mm (voir pages 42)

Set d'égalisation 1° (voir pages 42)

Nettoyage (voir pages 38)



Exemples de montage (voir pages 32)

Dysfonctionnement

Manque d'étanchéité important de la douche

Origine

- Douche encrassée / entartrée

Solution

- Nettoyer / détartrer la douche voir pages 38



Safety Notes

- △ Gloves should be worn during installation to prevent crushing and cutting injuries.
- △ The arm of the shower head is intended only to hold the shower head. Do not load it down with other objects!
- △ The shower may only be used for bathing, hygiene and body cleaning purposes.

Installation Instructions

- Prior to installation, inspect the product for transport damages. After it has been installed, no transport or surface damage will be honoured.
- The pipes and the fixture must be installed, flushed and tested as per the applicable standards.
- The plumbing codes applicable in the respective countries must be observed.
- The product is not designed to be used with steam baths!

Technical Data

Operating pressure: max. 0,6 MPa
 Recommended operating pressure: 0,3 - 0,4 MPa
 (1 MPa = 10 bar = 147 PSI)
 Hot water temperature: max. 60 °C
 Thermal disinfection: max. 70 °C / 4 min
 This mixer cannot be used in conjunction with hydraulically, electronically or thermally controlled instantaneous heaters.
 The product is exclusively designed for drinking water!

Symbol description

- for cold water
- Warm water
- The wall must be reinforced in this area.
- Plug the unused outlet.
- Waste
- Do not use silicone containing acetic acid!

Dimensions (see page 37)

Flow diagram (see page 32)

Spare parts (see page 42)

Special accessories

- order as an extra
- extension 25 mm (see page 42)
- levelling set 1 ° (see page 42)

Cleaning (see page 38)

Installation example (see page 32)



Fault

Cause

Remedy

Head shower extremely leaky

- Head shower soiled / scaled

- Clean / descale head shower see page 38



Indicazioni sulla sicurezza

- ⚠ Durante il montaggio, per evitare ferite da schiacciamento e da taglio bisogna indossare guanti protettivi.
- ⚠ Il braccio del soffione della doccia è progettato per sostenere solo quest'ultimo, non va sovraccaricato con altri oggetti!
- ⚠ La doccia deve essere impiegata solo per il bagno e utilizzo igienico e pulizia del corpo.

Istruzioni per il montaggio

- Prima del montaggio è necessario controllare che non ci siano stati danni durante il trasporto. Una volta eseguito il montaggio, non verranno riconosciuti eventuali danni di trasporto o delle superfici.
- Montare, lavare e controllare tubature e rubinetteria rispettando le norme correnti.
- Vanno rispettate le direttive di installazione nazionali vigenti nel rispettivo paese.
- Il prodotto non è predisposto per l'impiego in combinazione con un bagno a vapore.

Dati tecnici







Pressione d'uso: max. 0,6 MPa
 Pressione d'uso consigliata: 0,3 - 0,4 MPa
 (1 MPa = 10 bar = 147 PSI)

Temperatura dell'acqua calda: max. 60 °C
 Disinfezione termica: max. 70 °C / 4 min

I miscelatori non sono compatibili con le caldaie istantanee.

Il prodotto è concepito esclusivamente per acqua potabile!

Descrizione simbolo

-  acqua fredda
-  Acqua calda
-  In questa zona è necessario un rinforzo della parete.
-  Chiudere con un tappo l'uscita non utilizzata.
-  Scarico
-  Non utilizzare silicone contenente acido acetico!

Ingombri (vedi pagg. 37)

Diagramma flusso (vedi pagg. 32)

Parti di ricambio (vedi pagg. 42)

Accessori speciali

non contenuto nel volume di fornitura

 Prolunga 25 mm (vedi pagg. 42)

 Elemento per la regolazione in altezza 1° (vedi pagg. 42)

 **Pulitura** (vedi pagg. 38)

 **Esempio di installazione** (vedi pagg. 32)

Problema

Possibile causa

Rimedio

Doccia di testa non ermetica

- Doccia di testa sporca / calcificata

- Pulire / decalcificare la doccia di testa vedi pagg. 38



Indicaciones de seguridad

- ⚠ Durante el montaje deben utilizarse guantes para evitar heridas por aplastamiento o corte.
- ⚠ El brazo del pulverizador de ducha solo está previsto para soportar el pulverizador de ducha y no debe cargarse con otros objetos!
- ⚠ La roseta de ducha solo debe utilizarse para fines de baño, higiene y limpieza corporal.

Indicaciones para el montaje

- Antes del montaje se debe examinarse el producto contra daños de transporte. Después de la instalación no se reconoce ningún daño de transporte o de superficie.
- Los conductos y la grifería deben montarse, lavarse y comprobarse según las normas vigentes.
- Es obligatorio el cumplimiento de las directrices de instalación vigentes en el país respectivo.
- ¡El producto no ha sido diseñado para uso en conexión con un baño de vapor!

Datos técnicos

Presión en servicio: max. 0,6 MPa
 Presión recomendada en servicio: 0,3 - 0,4 MPa
 (1 MPa = 10 bar = 147 PSI)
 Temperatura del agua caliente: max. 60°C
 Desinfección térmica: max. 70°C / 4 min
 Los mezcladores no pueden usarse con calentadores instantáneos mandados hidráulicamente o térmicamente.

El producto ha sido concebido exclusivamente para agua potable.

Descripción de símbolos

- agua caliente
- Agua caliente
- En este sector es necesario un refuerzo del muro.
- La salida que no se utiliza debe ser tapada.
- Desagüe
- No utilizar silicona que contiene ácido acético!

Dimensiones (ver página 37)

Diagrama de circulación (ver página 32)

Repuestos (ver página 42)

Opcional

- no incluido en el suministro
- Prolongación 25 mm (ver página 42)
- set de nivelación 1° (ver página 42)

Limpiar (ver página 38)

Ejemplos de montaje (ver página 32)

Problema

Causa

Solución

Ducha con muchas fugas

- Ducha sucia / calcificada

- Limpiar / descalcificar la ducha ver página 38





Veiligheidsinstructies

- ⚠ Bij de montage moeten ter voorkoming van knel- en snijwonden handschoenen worden gedragen.
- ⚠ De arm van de hoofddouche is uitsluitend voor het vasthouden van de hoofddouche bedoeld en mag niet met verdere voorwerpen worden belast!
- ⚠ De douche uitsluitend toepassen in badkamers ten behoeve van lichaamsreiniging.

Montage-instructies

- Vóór de montage moet het product gecontroleerd worden op transportschade. Na de inbouw wordt geen transport- of oppervlakteschade meer aanvaard.
- De leidingen en armaturen moeten gemonteerd, gespoeld en gecontroleerd worden volgens de geldige normen.
- De in de overeenkomstige landen geldende installatierichtlijnen moeten nageleefd worden.
- Het product is niet voorzien voor gebruik in combinatie met een stoombad!

Technische gegevens

Werkdruk: max. max. 0,6 MPa
 Aanbevolen werkdruk: 0,3 - 0,4 MPa
 (1 MPa = 10 bar = 147 PSI)

Temperatuur warm water: max. 60 °C
 Thermische desinfectie: max. 70 °C / 4 min

Hansgrohe kranen mogen niet in verbinding met hydraulische en thermisch gestuurde geisers geplaatst worden.

Het product is uitsluitend ontworpen voor drinkwater!

Symboolbeschrijving

-  warm
-  Warm water
-  In dit bereik is een wandversterking noodzakelijk.
-  De niet benodigde uitgang moet met een blindstop worden afgedicht.
-  Afvoer
-  Gebruik geen zuurhoudende silicone!
-  **Maten** (zie blz. 37)
-  **Doorstroombiagram** (zie blz. 32)
-  **Service onderdelen** (zie blz. 42)
-  **Toebehoren**
- behoort niet tot het leveringspakket
-  Verlengstuk 25 mm (zie blz. 42)
-  nivelleerset 1° (zie blz. 42)
-  **Reinigen** (zie blz. 38)
-  **Montagevoorbeelden** (zie blz. 32)

Storing

Hoofdsproeier lekt sterk

Oorzaak

- Hoofdsproeier vuil / verkalkt

Oplossing

- Hoofdsproeier reinigen / ontkalken zie blz. 38



Sikkerhedsanvisninger

- △ Ved monteringen skal der bruges handsker for at undgå kvæstelser og snitsår.
- △ Stangen til hovedbruseren er kun beregnet til at holde hovedbruseren. Den må ikke belastes med andre genstande!
- △ Bruseren må kun bruges til at bruse, til hygiejne og rengøring af kroppen.

Monteringsanvisninger

- Før monteringen skal produktet kontrolleres for transportskader. Efter monteringen godkendes transportskader eller skader på overfladen ikke længere.
- Ledningerne og armaturerne skal monteres, skylles og kontrolleres iht. de gældende standarder.
- Installationsbestemmelserne, der gælder i det enkelte land, skal overholdes.
- Dette produkt er ikke beregnet til anvendelse i forbindelse med et dampbad!

Tekniske data

Driftstryk: max. 0,6 MPa
 Anbefalet driftstryk: 0,3 - 0,4 MPa
 (1 MPa = 10 bar = 147 PSI)

Varmtvandstemperatur: max. 60°C
 Termisk desinfektion: max. 70°C / 4 min

Hansgrohe armaturer kan ikke anvendes i forbindelse med hydraulisk og termisk styrede vandvarmere.
 Produktet er udelukkende beregnet til drikkevand!

Symbolbeskrivelse



varmtvandside



Varmt vand



I dette område er en forstærkning af væggen nødvendigt.



Afgangen, der ikke benyttes, skal afproppes.



Afløb



Der må ikke benyttes eddikesyreholdig silikone!



Målene (se s. 37)



Gennemstrømningsdiagram
(se s. 32)



Reservedele (se s. 42)

Specialtilbehør

ikke med i leveringsomfang



Forlængersæt 25 mm (se s. 42)



Nivelleringsæt 1° (se s. 42)



Rengøring (se s. 38)



Monteringsseksempler (se s. 32)

Fejl

Bruser meget utæt

Årsag

- Bruser tilsmudset / kalket til

Hjælp

- Rengør / afkalk bruser se s. 38





Avisos de segurança

- ⚠ Durante a montagem devem ser utilizadas luvas de protecção, de modo a evitar ferimentos resultantes de entalamentos e de cortes.
- ⚠ O braço do chuveiro foi concebido apenas para servir de apoio à cabeça do chuveiro, pelo que não pode ser sujeito a cargas de objectos adicionais!
- ⚠ O chuveiro só pode ser utilizado para fins de higiene pessoal.

Avisos de montagem

- Antes da montagem deve-se controlar o produto relativamente a danos de transporte. Após a montagem não são aceites quaisquer danos de transporte ou de superfície.
- As tubagens e a torneira têm que ser montadas, enxaguadas e verificadas de acordo com as normas em vigor.
- A prescrições de instalação válidas nos respetivos países devem ser respeitadas.
- O produto não foi concebido para utilização em combinação com um banho de vapor!







Dados Técnicos

Pressão de funcionamento: max. 0,6 MPa
 Pressão de func. recomendada: 0,3 - 0,4 MPa
 (1 MPa = 10 bar = 147 PSI)
 Temperatura da água quente: max. 60°C
 Desinfecção térmica: max. 70°C / 4 min

As misturadoras não são compatíveis com o uso de esquentadores instantâneos hidráulicos, electrónicos ou térmicos.

Este produto foi única e exclusivamente concebido para água potável!

Descrição do símbolo

-  de água quente
-  Água quente
-  Nesta zona é necessário um reforço na parede.
-  Tamponar a saída não utilizada.
-  Escoamento
-  Não utilizar silicone que contenha ácido acético!



Medidas (ver página 37)

Fluxograma (ver página 32)

Peças de substituição (ver página 42)

Acessórios especiais

não incluído no volume de fornecimento

-  Crescente 25 mm (ver página 42)
-  conjunto de nivelamento 1° (ver página 42)

Limpeza (ver página 38)

Exemplos de montagem (ver página 32)

Falha

Cabeça do chuveiro com fuga acentuada

Causa

- Cabeça do chuveiro suja / calcificada

Solução

- Limpar / descalcificar a cabeça do chuveiro ver página 38



Wskazówki bezpieczeństwa

- △ Aby uniknąć zranień na skutek zgniecenia lub przecięcia, podczas montażu należy nosić rękawice ochronne.
- △ Ramię prysznica jest przystosowane do trzymania głowicy prysznica i nie może być obciążane innymi przedmiotami!
- △ Prysznic może być używany tylko do kąpieli, higieny i czyszczenia ciała.

Wskazówki montażowe

- Przed montażem należy skontrolować produkt pod kątem szkód transportowych. Po montażu nie widać żadnych szkód transportowych ani szkód na powierzchni.
- Przewody i armatura muszą być montowane, płukane i kontrolowane według obowiązujących norm.
- Należy przestrzegać wytycznych instalacyjnych obowiązujących w danym kraju.
- Produkt nie jest przewidziany do zastosowania w łaźni parowej!

Dane techniczne

Ciśnienie robocze:	maks. 0,6 MPa
Zalecane ciśnienie robocze:	0,3 - 0,4 MPa (1 MPa = 10 bary = 147 PSI)
Temperatura wody gorącej:	maks. 60°C
Dezynfekcja termiczna:	maks. 70°C / 4 min

Armatura Hansgrohe może być wykorzystywana w połączeniu z hydraulicznie, elektronicznie i termicznie sterowanym ogrzewaczem przepływowym.

Produkt przeznaczony wyłącznie do wody pitnej!

Opis symbolu



po stronie cieplej wody



Ciepła woda



W tym obszarze konieczne jest wzmocnienie ściany.



Niewykorzystany wylot należy zakorkować dołożonym w dostawie korkiem.



Odptyw

Nie stosować silikonów zawierających kwas octowy!



Wymiary (patrz strona 37)



Schemat przepływu
(patrz strona 32)



Części serwisowe (patrz strona 42)

Wyposażenie specjalne

Nie jest częścią dostawy



Przedłużka 25 mm (patrz strona 42)



zespół poziomujący 1° (patrz strona 42)



Czyszczenie (patrz strona 38)



Przykłady montażowe
(patrz strona 32)

Usterka

Bardzo nieszczelny prysznic

Przyczyna

- Prysznic zanieczyszczony / pokryty kamieniem

Pomoc

- Oczyszczyć prysznic / usunąć z niego kamień patrz strona 38





Bezpečnostní pokyny

- △ Pro zabránění řezným zraněním a pohmožděninám je nutné při montáži nosit rukavice.
- △ Držák sprchové hlavice je dimenzován pouze pro držení sprchové hlavice a nesmí se zatěžovat dalšími předměty!
- △ Sprcha smí být používána pouze za účelem koupání a tělesné hygieny.

Pokyny k montáži

- Před montáží je třeba produkt zkontrolovat, zda nebyl při transportu poškozen. Po zabudování nebudou uznány žádné škody způsobené transportem nebo poškození povrchu.
- Vedení a armatura musí být namontovány, propláchnuty a otestovány podle platných norem.
- Je třeba dodržovat montážní pravidla platné v dané zemi.
- Výrobek není určen k použití ve spojení s parní lázní!







Technické údaje

Provozní tlak: max. 0,6 MPa
 Doporučený provozní tlak: 0,3 - 0,4 MPa
 (1 MPa = 10 bar = 147 PSI)

Teplota horké vody: max. 60 °C
 Tepelná desinfekce: max. 70 °C / 4 min

Tento produkt nemůže být používán ve spojení s hydraulicky a teplotně řízenými průtokovými ohříváči. Výrobky Hansgrohe jsou vhodné pro přímý kontakt s pitnou vodou.

Popis symbolů

-  Strana studené vody
-  Teplá voda
-  V této oblasti je potřebné zesílení stěny.
-  Nepoužitý vývod musí být utěsněn zaslepovací zátkou.
-  Odtok
-  Nepoužívat silikon s obsahem kyseliny octové!

Rozměry (viz strana 37)

Diagram průtoku (viz strana 32)

Servisní díly (viz strana 42)

Zvláštní příslušenství

není součástí dodávky

prodloužení 25 mm (viz strana 42)

vyrovnávací sada 1° (viz strana 42)

Čištění (viz strana 38)

Příklady montáže (viz strana 32)

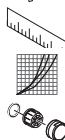

Porucha

Větší netěsnosti u hlavové sprchy

Příčina

- Znečištění / usazeniny vodního kamena na hlavové sprše

Odstranění

- Vyčistěte hlavovou sprchu / odstraňte vodní kámen viz strana 38



Bezpečnostné pokyny

- △ Pri montáži musíte nosiť rukavice, aby ste predišli pomliaždeninám a rezným poraneniam.
- △ Rameno držiaka hlavice sprchy je určené len na uchytienie hlavice sprchy a nesmie sa zaťažovať inými predmetmi!
- △ Sprcha sa smie používať len na účely kúpania a telesnej hygieny.

Pokyny pre montáž

- Pred montážou musíte produkt skontrolovať, či nebol počas transportu poškodený. Po zabudovaní nebudú uznané žiadne škody spôsobené transportom alebo poškodenia povrchu.
- Potrubia a vybavenie musia byť namontované, prepláchnuté a vybavené v platnom normami.
- Je potrebné dodržiavať smernice o inštalácii, ktoré sú práve teraz platné v krajinách.
- Výrobok nie je vhodný na použitie v spojení s parným kúpeľom!

Technické údaje

Prevádzkový tlak: max. 0,6 MPa
 Doporučený prevádzkový tlak: 0,3 - 0,4 MPa
 (1 MPa = 10 bar = 147 PSI)

Teplota teplej vody: max. 60°C
 Termická dezinfekcia: max. 70°C / 4 min

Tento produkt sa nesmie používať v spojení s hydrauliky a teplotne riadenými prietokovými ohrievačmi.
 Výrobok je koncipovaný výhradne pre pitnú vodu!

Popis symbolov



Strana studenej vody



Teplá voda



V tejto oblasti je potrebné zosilnenie steny.



Nepoužitý vývod musí byť zaslepený zátkou.



Odtok



Nepoužívať silikón s obsahom kyseliny octovej!

Rozmery (viď strana 37)

Diagram prietoku (viď strana 32)

Servisné diely (viď strana 42)

Zvláštné príslušenstvo

nie je súčasťou dodávky



Predĺženie 25 mm (viď strana 42)



zarovnávacia sada 1° (viď strana 42)



Čistenie (viď strana 38)



Príklady montáže (viď strana 32)

Porucha

Vrchná sprcha veľmi netečná

Príčina

- Vrchná sprcha znečistená /
zavápnená

Pomoc

- Vyčistíte / odvápnite vrchnú sprchu
viď strana 38





安全技巧

- △ 装配时为避免挤压和切割受伤，必须戴上手套。
- △ 头顶花洒夹持杆只为夹持头顶花洒而设计，不得让其承载其它物品！
- △ 该莲蓬头仅允许作淋浴、卫生保健和身体清洁目的使用。

安装提示

- 安装前必须检查产品是否受到运输损害。安装后将不认可运输损害或表面损伤。
- 管道和阀门必须根据通用标准进行安装、冲洗和检查。
- 请遵守当地国家现行的安装规定。
- 本产品并非设计来与蒸气浴连接使用！

技术参数

工作压强: 最大 0,6 MPa

推荐工作压强: 0,3 - 0,4 MPa
(1 MPa = 10 bar = 147 PSI)















热水温度: 最大 60°C

热力消毒: 最大 70°C / 4 分钟

该产品不可与液控和热控即热式热水器连接使用。

该产品专为饮用水设计！

符号说明

-  冷水端
-  热水
-  该区域需要一个加固边壁。
-  插入不使用的插座。
-  排水口
-  请勿使用含有乙酸的硅胶！
-  大小 (参见第页 37)
-  流量示意图 (参见第页 32)
-  备用零件 (参见第页 42)
- ### 选装附件
-  不在供货范围内
-  加长 25 mm (参见第页 42)
-  调平装置 1° (参见第页 42)
-  清洗 (参见第页 38)
-  安装示意 (参见第页 32)

问题	原因	补救
花洒头严重泄露	- 花洒头脏污/产生钙质垢	- 清洁花洒头/去除钙质垢 参见第页 38



Указания по технике безопасности

- △ Во время монтажа следует надеть перчатки во избежание прищемления и порезов.
- △ Кронштейн верхнего душа предназначен только для подсоединения верхнего душа. Запрещается подвешивать на него другие предметы!
- △ Источник разбрызгивания разрешается использовать только в гигиенических целях для принятия ванны и личной гигиены.

Указания по монтажу

- Перед монтажом следует проверить изделие на предмет повреждений при перевозке. После монтажа претензии о возмещении ущерба за повреждения при перевозке или повреждения поверхностей не принимаются.
- Трубы и арматура должны быть установлены, промыты и проверены в соответствии с действующими нормами.
- Необходимо соблюдать требования по монтажу, действующие в соответствующих странах.
- Изделие не предназначено для использования в паровой бане!

Технические данные

Рабочее давление: не более. 0,6 МПа
 Рекомендуемое рабочее давление: 0,3 - 0,4 МПа
 (1 МПа = 10 bar = 147 PSI)

Температура горячей воды: не более. 60 °C

Термическая дезинфекция: не более. 70 °C / 4 мин

Применение этой продукции при наличии гидравлических и проточных нагревателей с тепловой регулировкой не допускается.

Изделие предназначено исключительно для питьевой воды!

Описание символов



Страна холодной воды



Теплая вода



В этой области требуется укрепление стены.



Ненужный выход необходимо уплотнить с помощью заглушки.



Слив



Не применяйте силикон, содержащий уксусную кислоту.



Размеры (см. стр. 37)



Схема потока (см. стр. 32)



Комплект (см. стр. 42)

Специальные принадлежности

не включено в объем поставки!



Удлинение 25 мм (см. стр. 42)



комплект для выравнивания 1° (см. стр. 42)



Очистка (см. стр. 38)



варианты установки (см. стр. 32)

Неисправность

Сильная течь в душевой головке

Причина

- Душевая головка засорилась / покрылась известковым налетом

Устранение неисправности

- Почистить душевую головку / удалить известковый налет см. стр. 38





Turvallisuusohjeet

- △ Asennuksessa on käytettävä käsiineitä puristumien ja viiltojen aiheuttamien tapaturmien estämiseksi.
- △ Pääsuihkun varsi on tarkoitettu vain kannattamaan pääsuihkua. Sitä ei saa kuormittaa muilla esineillä!
- △ Suihkua saa käyttää vain kylpy-, hygienia ja kehonpuhdistustarkoituksiin.

Asennusohjeet

- Ennen asennusta on tarkastettava tuotteen mahdolliset kuljetusvahingot. Asennuksen jälkeen kuljetus- ja pintavaurioita ei hyväksytä.
- Putket ja hana on asennettava, huuhdeltava ja tarkastettava voimassa olevien standardien mukaisesti.
- Jokaisessa maassa on noudatettava siellä päteviä asennusohjeita.
- Tuotetta ei ole tarkoitettu käytettäväksi yhdessä höyrykylvyn kanssa!

Tekniset tiedot





Käyttöpaine: maks. 0,6 MPa
 Suositeltu käyttöpaine: 0,3 - 0,4 MPa
 (1 MPa = 10 bar = 147 PSI)

Kuuman veden lämpötila: maks. 60 °C
 Lämpödesinfektio: maks. 70 °C / 4 min

Tätä tuotetta ei voi käyttää hydraulisesti tai termisesti ohjattujen läpivirtauskuumentimien yhteydessä.

Tuote on suunniteltu käytettäväksi ainoastaan juomaveden kanssa!

Merkin kuvaus

-  Kylmävesipuoli
-  Lämmin vesi
-  Tässä kohdassa seinää on vahvistettava
-  Käyttömätön lähtöliitin on suljettava sulikutulppalla.



-  Veden poisvirtaus
- Älä käytä etikahappopitoista silikoniala!

 **Mitat** (katso sivu 37)

 **Virtausdiagrammi** (katso sivu 32)

 **Varaosat** (katso sivu 42)

Eriyisvaruste

- ei kuulu toimitukseen
-  Pidennys 25 mm (katso sivu 42)
-  suihkusäädin 1° (katso sivu 42)

 **Puhdistus** (katso sivu 38)

 **Asennusesimerkkejä** (katso sivu 32)

Häiriö

Pääsuihku erittäin epätiivis

Syy

- Pääsuihku likaantunut / kalkkeutunut

Toimenpide

- Pääsuihkun puhdistus / kalkinpoisto katso sivu 38



Säkerhetsanvisningar

- △ Handskar ska bäras under monteringsarbetet så att man kan undvika kläm- och skärskador.
- △ Armen som håller huvudduschen är bara konstruerad för detta; den får inte belastas med andra föremål!
- △ Duschen får bar användas till dusch-, bad- och personlig hygien.

Monteringsanvisningar

- Det måste undersökas om produkten har transportskador innan den monteras. Efter monteringen accepteras inga transport- eller ytskiktsskador.
- Ledningarna och blandaren måste monteras, spolas igenom och kontrolleras enligt de gällande normerna.
- De installationsriktlinjer som gäller i länderna ska följas.
- Produkten är inte avsedd att användas tillsammans med ett ångbad!

Tekniska data

Driftstryck: max. 0,6 MPa
 Rek. driftstryck: 0,3 - 0,4 MPa
 (1 MPa = 10 bar = 147 PSI)

Varmvattentemperatur: max. 60 °C
 Termisk desinfektion: max. 70 °C / 4 min

Denna produkt kan inte användas tillsammans med hydrauliskt och termiskt styrda varmvattenberedare.
 Produkten är enbart avsedd för dricksvatten!

Symbolförklaring

- Kallvattensida
- Varmvatten
- Šioje zonoje būtinās sienos sutvirtinimas
- Det utlopp som inte behövs måste tätas med en blindstopp.
- Avlopp
- Använd inte silikon som innehåller ättiksyra!
- Måtten** (se sidan 37)
- Flödesschema** (se sidan 32)
- Reservdelar** (se sidan 42)
- Specialtillbehör**
medföljer ej leveransen
- Förlängning 25 mm (se sidan 42)
- Utjämningsset 1° (se sidan 42)
- Rengöring** (se sidan 38)
- Monteringsexempel** (se sidan 32)

Störning

Duschkunstycket mycket otätt

Orsak

- Duschkunstycket smutsigt/
förekalkat

Åtgärd

- Rengör/avkalka duschkunstycket
se sidan 38



Saugumo technikos nurodymai

- △ Apsaugai nuo užspaudimo ir įsijovimo montavimo metu mūvėkite pirštines.
- △ Dušo laikiklis skirtas tik dušo galvutei laikyti, todėl neturi būti apkraunamas kitokiais daiktais!
- △ Dušo galva naudojama tik maudymosi, higieniniais ir kūno švarinimo tikslais.

Montavimo instrukcija

- Prieš montuojant būtina patikrinti, ar gaminyje nebuvo pažeistas transportavimo metu. Sumontavus pretenzijos dėl transportavimo ir paviršiaus pažeidimų nepriimamos.
- Vamzdžiai ir sujungimai turi būti montuojami, plaunami ir tikrinami pagal galiojančias normas.
- Laikykitės atitinkamoje šalyje galiojančių direktyvų dėl įrengimo.
- Gaminis netinkamas naudoti garo pirtyje!

Techniniai duomenys







Darbinis slėgis: ne daugiau kaip 0,6 MPa
 Rekomenduojamas slėgis: 0,3 - 0,4 MPa
 (1 MPa = 10 barų = 147 PSI)

Karšto vandens temperatūra: ne daugiau kaip 60 °C
 Terminis dezinfekavimas: ne daugiau kaip 70 °C / 4 min

Šio produkto negalima naudoti kartu su hidrauliškai ir termiškai valdomu tekančio vandens šildytuvu.

Produktas skirtas tik geriamajam vandeniui!

Simbolio aprašymas

-  Šalto vandens pusė
-  Šiltas vanduo
-  Šioje zonoje būtinas sienos sutvirtinimas
-  Nenaudojamą išėjimą užaklinti.
-  Nutekėjimas
-  Nenaudokite silikono, kurio sudėtyje yra acto rūgšties!

Išmatavimai (žr. psl. 37)

Pralaidumo diagrama (žr. psl. 32)

Atsarginės dalys (žr. psl. 42)

Specialūs priedai

nėra pridedama

Ilgiklis 25 mm (žr. psl. 42)

lygio regulatorius 1° (žr. psl. 42)

Valymas (žr. psl. 38)

Montavimo pavyzdžiai (žr. psl. 32)

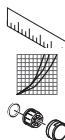

Gedimas

Labai nesandari dušo galva

Priežastis

- Užsiteršusi / užkalkėjusi dušo galva

Priemonė

- Išvalykite dušo galvą / pašalinkite iš jos kalkių nuosėdas žr. psl. 38



Sigurnosne upute

- ⚠ Prilikom montaže se radi sprječavanja prignječenja i posjekotina moraju nositi rukavice.
- ⚠ Nosač tuša iznad glave je dimenzioniran samo za držanje danog tuša i ne smije se opterećivati drugim predmetima!
- ⚠ Tuš se smije primjenjivati samo za kupanje, tuširanje i osobnu higijenu.







Upute za montažu

- Prije montaže mora se provjeriti je li proizvod oštećen prilikom transporta. Nakon ugradnje se ne priznaju nikakve reklamacije koje se odnose na površinska i transportna oštećenja.
- Cijevi i armatura moraju biti postavljeni, isprani i testirani prema važećim normama.
- Obvezno se moraju uvažiti propisi o instalacijama koji vrijede u dotičnoj zemlji.
- Proizvod nije predviđen za primjenu u parnim kupatonicama!

Tehnički podatci

Najveći dopušteni tlak: tlak 0,6 MPa
 Preporučeni tlak: 0,3 - 0,4 MPa
 (1 MPa = 10 bar = 147 PSI)
 Temperatura vruće vode: tlak 60°C
 Termička dezinfekcija: tlak 70°C / 4 min
 Ovaj proizvod se ne može rabiti uz hidraulički i termički regulirane protočne bojlere.
 Proizvod je koncipiran isključivo za pitku vodu!

Opis simbola

-  Hladna voda
-  Topla voda
-  U ovom je području potrebno ojačanje zida.
-  Potrebno je ostaviti zatvoren izlaz koji se ne koristi
-  Odvod
-  Nemojte koristiti silikon koji sadrži octenu kiselinu!



Mjere (pogledaj stranicu 37)

Dijagram protoka (pogledaj stranicu 32)

Rezervni dijelovi (pogledaj stranicu 42)

Posebni pribor

Nije sadržano u isporuci!

-  Produljenje 25 mm (pogledaj stranicu 42)
-  komplet za podešavanje 1° (pogledaj stranicu 42)

Čišćenje (pogledaj stranicu 38)

Primjeri instalacija (pogledaj stranicu 32)

Greška

Tuš iznad glave jako propušta

Uzrok

- Tuš iznad glave je onečišćen / ima naslaga kamenca

Otklanjanje

- Očistite odnosno uklonite kamenac s tuša iznad glave pogledaj stranicu 38



⚠ Güvenlik uyarıları

- ⚠ Montaj esnasında ezilme ve kesilme gibi yaralanmaları önlemek için eldiven kullanılmalıdır.
- ⚠ Başlıklı püskürtücü kolu yalnızca başlıklı püskürtücünün tutulması için tasarlanmıştır, başka nesnelere üzerine yük bindirilmemelidir!
- ⚠ Su püskürtücü yalnızca banyo, hijyen ve yıkanma amaçları için kullanılabilir.

Montaj açıklamaları

- Montaj işleminden önce ürün nakliye hasarları yönünden kontrol edilmelidir. Montaj işleminden sonra nakliye veya yüzey hasarları için sorumluluk üstlenilmemektedir.
- Boruların ve armatürün montajı, yıkanması ve kontrolü geçerli normlara göre yapılmalıdır.
- Ülkelerde geçerli kurulum yönetmeliklerine riayet edilmelidir.
- Ürün bir buhar banyosu ile bağlantılı olarak kullanım için öngörülmemiştir!











Teknik bilgiler

İşletme basıncı: azami 0,6 MPa
Tavsiye edilen işletme basıncı: 0,3 - 0,4 MPa
(1 MPa = 10 bar = 147 PSI)

Sıcak su sıcaklığı: azami 60°C
Termik dezenfeksiyon: azami 70°C / 4 dak

Bu ürün hidrolik ve termik kumandalı akış ısıtıcılarıyla bağlantılı olarak kullanılmamalıdır.
Ürün sadece şebeke suyu için tasarlanmıştır!

Simge açıklaması

-  Soğuk su tarafı
-  Sıcak su
-  Bu alanda duvarın kalınlaştırılması gereklidir.
-  Kullanılmayan çıkış bir kör tapayla izole edilmelidir.
-  Akış
Asetik asit içeren silikon kullanmayın!
-  Ölçüleri (bakınız sayfa 37)
-  Akış diyagramı (bakınız sayfa 32)
-  Yedek Parçalar (bakınız sayfa 42)
-  Özel aksesuarlar
Teslimat kapsamına dahil değildir
Uzatma 25 mm (bakınız sayfa 42)
tesfiye ayarlı 1° (bakınız sayfa 42)
-  Temizleme (bakınız sayfa 38)
-  Montaj Örneği (bakınız sayfa 32)

arıza

Yağış duş başlığı çok sızdırıyor

sebebi

- Yağış duş başlığı kirli / kireçli

yardım

- Yağış duş başlığını temizleyin / kirecini temizleyin bakınız sayfa 38



Instrucțiuni de siguranță

- ⚠ La montare utilizați mănuși pentru evitarea contuziunilor și tăierii mâinilor.
- ⚠ Brațul parei de duș este destinat doar pentru a susține para, acesta nu poate fi prevăzut cu alte obiecte.
- ⚠ Dușul poate fi utilizat doar în scopuri de spălare, igienizare și de întreținere a igienei corporale.

Instrucțiuni de montare

- Înainte de instalare verificați, dacă produsul prezintă deteriorări de transport. După instalare garanția nu acoperă deteriorările de transport și cele de suprafață.
- Conductele și bateriile trebuie montate, spălate și verificate conform normelor în vigoare.
- Respectați reglementările referitoare la instalare valabile în țara respectivă.
- Produsul nu este prevăzut pentru a fi folosit în combinație cu o baie de aburi!

Date tehnice

Presiune de funcționare: max. 0,6 MPa
 Presiune de funcționare recomandată: 0,3 - 0,4 MPa
 (1 MPa = 10 bar = 147 PSI)
 Temperatura apei calde: max. 60°C
 Dezinfecție termică: max. 70°C / 4 min

Acest produs nu poate fi utilizat în combinație cu boilere cu flux continuu hidraulice sau comandate termic.

Produsul este destinat exclusiv pentru apă potabilă.

Descrierea simbolurilor



Partea pentru apă rece



Apă caldă



În această zonă este nevoie de întărirea peretelui.



Racordurile neutilizate trebuie acoperite cu dop etanș.



Deversor



Nu utilizați silicon cu conținut de acid acetic!



Dimensiuni (vezi pag. 37)



Diagrama de debit (vezi pag. 32)



Piese de schimb (vezi pag. 42)

Accesorii opționale

nu este inclus în setul livrat



Prelungitor 25 mm (vezi pag. 42)



Set sortimente 1° (vezi pag. 42)



Curățare (vezi pag. 38)



Exemple de montare (vezi pag. 32)

Deranjament

Capul de duș prezintă scurgeri masive

Cauza

- Capul de duș este înfundat / calcifiat

Măsurile de remediere

- Curățați / decalcificați capul de duș vezi pag. 38





Υποδειξεις ασφαλείας

- ⚠ Για να αποφύγετε τραυματισμούς κατά τη συναρμολόγηση πρέπει να φοράτε γάντια.
- ⚠ Ο βραχίονας του ντους κεφαλιού έχει μελετηθεί μόνο για να κρατά το ντους κεφαλιού, δεν επιτρέπεται να φορτίζεται με άλλα αντικείμενα!
- ⚠ Το ντους επιτρέπεται να χρησιμοποιείται μόνο για το μπάνιο, τον καθαρισμό και την υγιεινή του σώματος.

Οδηγίες συναρμολόγησης

- Πριν τη συναρμολόγηση πρέπει να εξεταστεί το προϊόν για ζημιές μεταφοράς. Μετά την εγκατάσταση δεν αναγνωρίζονται ζημιές από τη μεταφορά ή επιφανειακές ζημιές.
- Οι σωλήνες και η μπαταρία πρέπει να τοποθετηθούν σύμφωνα με τα ισχύοντα πρότυπα, να τεθούν υπό πίεση και να δοκιμαστούν.
- Θα πρέπει να τηρούνται οι οδηγίες εγκατάστασης που ισχύουν σε κάθε κράτος.
- Το προϊόν δεν είναι κατάλληλο για χρήση σε ατμόλουτρο!











Τεχνικά Χαρακτηριστικά

Λειτουργία πίεσης: έως 0,6 MPa
 Συνιστώμενη λειτουργία πίεσης: 0,3 - 0,4 MPa
(1 MPa = 10 bar = 147 PSI)
 Θερμοκρασία ζεστού νερού: έως 60 °C
 Θερμική απολύμανση: έως 70 °C / 4 min





Αυτό το προϊόν δεν μπορεί να χρησιμοποιηθεί σε συνδυασμό με υδραυλικούς και θερμικά ελεγχόμενους ταχυθερμοσίφωνες.

Το προϊόν έχει σχεδιαστεί αποκλειστικά για πόσιμο νερό!

Περιγραφή συμβόλων

-  Πλευρά κρύου νερού
-  Ζεστό νερό
-  Σε αυτήν την περιοχή είναι απαραίτητη μία ενίσχυση του τοίχου.
-  Τα περιττά στόμια εξόδου πρέπει να στεγανοποιηθούν με ένα τυφλό πώμα.
-  Βαλβίδα εκροής
-  Μην χρησιμοποιείτε σιλικόνη που περιέχει οξικό οξύ!
-  **Διαστάσεις** (βλ. Σελίδα 37)
-  **Διάγραμμα ροής** (βλ. Σελίδα 32)
-  **Ανταλλακτικά** (βλ. Σελίδα 42)
-  **Ειδικά αξεσουάρ**

δεν περιλαμβάνεται στον παραδοτέο εξοπλισμό

-  Επιμήκυνση 25 mm (βλ. Σελίδα 42)
-  σετ οριζοντίωσης (αλφάδιασμα) 1° (βλ. Σελίδα 42)
-  **Καθαρισμός** (βλ. Σελίδα 38)
-  **Παραδείγματα συναρμολόγησης** (βλ. Σελίδα 32)

Βλάβη

Ντους κεφαλιού ιδιαίτερα μη στεγανό

Αιτία

- Ντους κεφαλιού ακάθαρμο / με άλατα

Διόρθωση

- Καθαρίστε το ντους κεφαλιού / αφαιρέστε τα άλατα βλ. Σελίδα 38



Varnostna opozorila

- ⚠ Pri montaži je treba nositi rokavice, da se preprečijo poškodbe zaradi zmečkanja ali urezov.
- ⚠ Nosilna roka naglavne prhe je konstruirana le za nošenje prhe in je ne smete obremeniti z drugimi predmeti!
- ⚠ Prha se sme uporabljati le z namenom vzdrževanja higiene oziroma umivanja kopalnice in telesa.

Navodila za montažo

- Pred montažo je treba izdelek preveriti glede morebitnih transportnih poškodb. Po vgradnji transportne ali površinske poškodbe ne bodo več priznane.
- Cevi in armaturo je treba montirati, izprati in preveriti po veljavnih standardih.
- Upoštevati je treba pravilnike o inštalacijah, ki veljajo v posamezni državi.
- Proizvod ni predviden za uporabo v povezavi s parno kopaljo!

Tehnični podatki

Delovni tlak: maks. 0,6 MPa
 Priporočeni delovni tlak: 0,3 - 0,4 MPa
 (1 MPa = 10 bar = 147 PSI)

Temperatura tople vode: maks. 60°C
 Termična dezinfekcija: maks. 70°C / 4 min

Tega proizvoda ni možno uporabiti v povezavi s hidravlično in termično krmiljenimi pretočnimi grelniki.
 Proizvod je zasnovan izključno za sanitarno vodo!

Opis simbola

- Stran za hladno vodo
- Topla voda
- V tem območju je potrebno ojačanje stene.
- Izhod, ki ga ne potrebujete, zatesnite s čepom.
- Odtok
- Ne smete uporabiti silikona, ki vsebuje ocetno kislino!

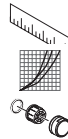

Mere (glejte stran 37)

Diagram pretoka (glejte stran 32)

Rezervni deli (glejte stran 42)

Poseben pribor

Ni vključeno



Podaljšek 25 mm (glejte stran 42)

Izravnalni komplet 1° (glejte stran 42)

Čiščenje (glejte stran 38)



Primeri montaže (glejte stran 32)

Napaka

Prha zelo netesna

Vzrok

- Prha umazana / poapnena

Pomoč

- Prho očistite / odstranite apnenec
glejte stran 38



Ohutusjuhised

- △ Kandke paigaldamisel muljumis- ja löikevigastuste vältimiseks kindaid.
- △ Dušipea hoidik on mõeldud ainult dušipea hoidmiseks ja seda ei tohi muude esemetega koormata!
- △ Dušši tohib kasutada ainult vanniskäimiseks, hügieeniks ja keha pesemiseks.

Paigaldamisjuhised

- Enne paigaldamist tuleb toodet kontrollida transpordikahjustuste osas. Pärast paigaldamist ei tunnustata enam transpordi- või pinnakahjustuste kaebuseid.
- Voolikute ja segisti paigaldamisel, loputamisel ja kontrollimisel tuleb lähtuda kehtivatest normatiividest
- Vastavas riigis kehtivaid paigalduseeskirju tuleb järgida.
- Toode ei sobi kasutamiseks aurusaunas!

Tehnilised andmed

Töörõhk maks. 0,6 MPa
 Soovitatav töörõhk: 0,3 - 0,4 MPa
 (1 MPa = 10 baari = 147 PSI)

Kuuma vee temperatuur: maks. 60°C
 Termiline desinfektsioon: maks. 70°C / 4 min

Seda toodet ei saa kasutada koos hüdrauliliselt ja termiliselt juhitava läbivoolusoojendiga.

Toode on ette nähtud eranditult joogivee jaoks!

Sümbolite kirjeldus

-  Külma vee pool
-  Soe vesi
-  Selles alas tuleb seina tugevdada.
-  Mittevajalik väljavool tuleb sulgeda korgiga.
-  Äravool
-  Ärge kasutage äädikhapet sisaldavat silikoonil!
-  **Mõõtude** (vt lk 37)
-  **Läbivooludiagramm** (vt lk 32)
-  **Varuosad** (vt lk 42)
-  **Spetsiaalne lisavarustus**
ei sisaldu komplektis
-  pikendus 25 mm (vt lk 42)
-  tasanduskomplekt 1° (vt lk 42)
-  **Puhastamine** (vt lk 38)
-  **Paigalduse näited** (vt lk 32)

Rike

Vihmadušš lekitab tugevalt

Põhjus

- Vihmadušš määrduunud/katlakivine

Lahendus

- Puhastada vihadušš/eemaldada katlakivi vt lk 38



Drošības norādes

- △ Montāžas laikā, lai izvairītos no saspiedumiem un iegriezumiem, nepieciešams nēsāt cimdus.
- △ Galvas dušas statīvs paredzēts vienīgi galvas dušas atbalstīšanai, to nedrīkst noslogot ar citiem priekšmetiem!
- △ Dušu drīkst izmantot vienīgi vannošānās, higiēnas un ķermeņa tīrīšanas nolūkiem.

Norādījumi montāžai

- Pirms montāžas nepieciešams pārbaudīt, vai produktam transportēšanas laikā nav radušies bojājumi. Pēc iebūvēšanas bojājumi, kas radušies transportēšanas laikā, vai virsmas bojājumi netiek atzīti.
- Cauruļvadi un armatūra ir jāuzstāda, jāizskalo un jāpārbauda saskaņā ar spēkā esošajiem standartiem.
- Jāievēro attiecīgās valstīs spēkā esošās montāžas prasības.
- Produkts nav paredzēts lietošanai kopā ar tvaika vannu!

Tehniskie dati

Darba spiediens: maks. 0,6 MPa
 leteicamais darba spiediens: 0,3 - 0,4 MPa
 (1 MPa = 10 bar = 147 PSI)

Karstā ūdens temperatūra: maks. 60 °C
 Termiskā dezinfekcija : maks. 70 °C / 4 min

Šo izstrādājumu nevar uzstādīt kopā ar hidrauliski un termiski vadītu caurplūdes sildītāju.
 Izstrādājums ir paredzēts tikai dzeramajam ūdenim!

Simbolu nozīme

- Aukstā ūdens puse
- Siltais ūdens
- Šajā zonā ir nepieciešams pastiprināt sienu.
- Neizmantoto izteku aizbāzt ar aizbāzni.
- Notece
- Neizmantot silikonu, kas satur etiķskābi!
- Izmērus** (skat. lpp. 37)
- Caurplūdes diagramma** (skat. lpp. 32)
- Rezerves daļas** (skat. lpp. 42)
- Speciāli aksesuāri**
komplektā netiek piegādāts
- Pagarinājums 25 mm (skat. lpp. 42)
- nolīdzināšanas komplekts 1° (skat. lpp. 42)
- Tīrīšana** (skat. lpp. 38)
- Montāžas piemēri** (skat. lpp. 32)

Traucējums

Stipra sūce dušas galvā

Iemesls

- Dušas galva nefīra / pārkaļķojusies

Bojājumu novēršana

- Noņemt netīrumus / kaļķus skat. lpp. 38





Sigurnosne napomene

- △ Prilikom montaže se radi sprečavanja prignječenja i posekotina moraju nositi rukavice.
- △ Nosač tuša iznad glave je dimenzioniran samo za držanje datog tuša i ne sme se opterećivati drugim predmetima!
- △ Tuš sme da se koristi samo za kupanje, tuširanje i ličnu higijenu.

Instrukcije za montažu

- Pre montaže se mora proveriti da li je proizvod oštećen pri transportu. Nakon ugradnje se ne priznaju nikakve reklamacije koje se odnose na površinska i transportna oštećenja.
- Vodovi i armatura moraju biti postavljeni, isprani i testirani prema važećim normama.
- Treba se pridržavati propisa koji u određenim zemljama važe za instalacije.
- Proizvod nije predviđen za upotrebu u parnim kupatilima!

Tehnički podaci







Radni pritisak: maks. 0,6 MPa
 Preporučeni radni pritisak: 0,3 - 0,4 MPa
 (1 MPa = 10 bar = 147 PSI)

Temperatura vruće vode: maks. 60°C
 Termička dezinfekcija: maks. 70°C / 4 min

Ovaj proizvod se ne može koristiti uz hidraulički i termički regulisane protočne bojlere.

Proizvod je koncipiran isključivo za pijaću vodu!

Opis simbola

-  Hladna voda
-  Topla voda
-  U ovoj oblasti je potrebno ojačanje zida.
-  Izlaz koji se ne koristi, mora se zatvoriti slepim čepom.
-  Ispust
-  Nemojte koristiti silikon koji sadrži sirćetnu kiselinu!

Mere (vidi stranu 37)

Dijagram protoka (vidi stranu 32)

Rezervni delovi (vidi stranu 42)

Poseban pribor

- Nije sadržano u isporuci
- Produžetak 25 mm (vidi stranu 42)
- set za nivelisanje 1° (vidi stranu 42)

Čišćenje (vidi stranu 38)

Primeri montaže (vidi stranu 32)

Smetnja

Tuš iznad glave jako propušta

Uzrok

- Tuš iznad glave je prljav ili obložen naslagama kamena

Pomoć

- Očistite tuš iznad glave odnosno uklonite kamenac vidi stranu 38





Sikkerhetshenvisninger

- △ Bruk hansker under montasjen for å unngå klem- og kuttskader.
- △ Armen til hodedusjen er kun laget for å holde hodedusjen. Den må ikke belastes med andre gjenstander!
- △ Dusjen skal kun brukes for bading, til hygieneformål og til kroppsrengjøring

Montagehenvisninger

- Før montasjen skal produktet sjekkes for transportskader. Etter monteringen aksepteres ikke noen transport- eller overflateskader.
- Ledningene og armaturen skal monteres, spyles og sjekkes iht. de gyldige normer.
- Gjeldende retningslinjer for rørleggerarbeid i de enkelte land skal følges.
- Produktet er ikke påtenkt for bruk sammen med et dampbad!

Tekniske data

Driftstrykk maks. 0,6 MPa
 Anbefalt driftstrykk: 0,3 - 0,4 MPa
 (1 MPa = 10 bar = 147 PSI)

Varmtvannstemperatur maks. 60°C
 Termisk desinfisering: maks. 70°C / 4 min

Dette produktet kan ikke brukes i forbindelse med hydraulisk og termisk styrte gjennomstrømningovner. Produktet er utelukkende designet for drikkevann!

Symbolbeskrivelse



Kaldtvannside



Varmtvann



I dette området skal veggen forsterkes.



Utgangen som ikke brukes kan tettes med en blindplugg.



Avløp



Ikke bruk silikon som inneholder eddiksyre!



Mål (se side 37)



Gjennomstrømningsdiagram (se side 32)



Serviceleder (se side 42)

Ekstratilbehør

ikke med i leveransen



Forlengelse 25 mm (se side 42)



Utligningssett 1° (se side 42)



Rengjøring (se side 38)



Montasje-eksempel (se side 32)

Feil

Dusjhode meget utett

Årsak

- Dusjhode tilsmusset/forkalket

Feilrettelse

- Rengjør/kalkrens dusjhodet se side 38



Указания за безопасност

- ⚠ При монтажа трябва да се носят ръкавици, за да се избегнат наранявания поради притискане или порязване.
- ⚠ Рамото на разпръскателя за главата е разработено само, за да държи разпръскателя за главата, то не бива да се натоварва с други предмети!
- ⚠ Позволено е използването на разпръскателя само за къпане, хигиена и цели на почистване на тялото.

Указания за монтаж

- Преди монтажа продуктът трябва да се провери за транспортни щети. След монтажа не се признават транспортни или повърхностни щети.
- Тръбопроводите и арматурата трябва да се монтират, промият и проверят в съответствие с валидните норми.
- Трябва да бъдат спазвани валидните в съответните страни предписания за инсталиране.
- Продуктът не е предвиден за употреба във връзка с парна баня!







Технически данни

Работно налягане: макс. 0,6 МПа
 Препоръчително работно налягане: 0,3 - 0,4 МПа
 (1 МПа = 10 bar = 147 PSI)
 Температура на горещата вода: макс. 60°C
 Термична дезинфекция: макс. 70°C / 4 мин

Този продукт не може да се използва във връзка с хидравлично и термично управляеми проточни нагреватели.

Продуктът е разработен само за питейна вода!

Описание на символите

-  Страна на студената вода
-  Топла вода
-  В тази област е необходимо подсилване на стената.
-  Излишният извод може да се уплътни с глуха пробка.
-  Отвеждане
-  Не използвайте силикон, съдържащ оцетна киселина!



Размери (вижте стр. 37)

Диаграма на потока (вижте стр. 32)

Сервизни части (вижте стр. 42)

Специални принадлежности

не се съдържа в обема на доставка

-  Удължител 25 мм (вижте стр. 42)
-  изравняваща система 1° (вижте стр. 42)

Почистване (вижте стр. 38)

Примери за монтаж (вижте стр. 32)

Неизправност

Разпръскателят за главата е силно не уплътнен

Причина

- Разпръскател за главата замърсен / покрит с варовик

Помощ

- Почистете / освободете от варовик разпръскателя за главата вижте стр. 38



Udhëzime sigurie

- △ Për të evituar lëndimet e pickimeve ose të prerjeve gjatë procesit të montimit duhet që të vishni doreza.
- △ Mbjajtësja e kokës së dushit është projektuar vetëm për mbajtjen e kokës së dushit dhe nuk duhet që të rëndohet me objekte të tjera!
- △ Dushi duhet të përdoret vetëm për qëllimet e banjave, të higjienës dhe të larjes së trupit.

Udhëzime për montimin

- Përpara montimit duhet që produkti të kontrollohet për dëmtime nga transporti. Pas instalimit nuk do të njihet asnjë dëmtim nga transporti ose dëmtim i sipërfaqes.
- Tubacionet dhe rubinetet duhet që të montohen, të shpëlahen dhe të kontrollohen sipas standardeve në fuqi
- Duhet të respektohen linjat udhëzuese të instalimit, të vlefshme për vendet respektive.
- Pajisja nuk është parashikuar për përdorim në lidhje me një banjë me avull!

Të dhëna teknike

Presioni gjatë punës maks. 0,6 MPa
 Presioni i rekomanduar: 0,3 - 0,4 MPa
 (1 MPa = 10 bar = 147 PSI)

Temperatura e ujit të ngrohtë maks. 60 °C
 Dezinfektim Termik: maks. 70 °C / 4 min

Ky produkt nuk mund të përdoren me ngrohës elektrikë të ujit të drejtuara në mënyrë hidraulike ose termike.

Produkti është projektuar ekskluzivisht për ujë të pijshëm!

Përshkrimi i simbolit



Ana e ujit të ftohtë



Uji i ngrohtë



Në këtë zonë është i nevojshëm një përforsim i murit.



Dalja që nuk nevojitet duhet izoluar me tapë qorre.



Shkarkimi

Mos përdorni silikon që në përbërje ka acid acetik.



Përmasat (shih faqen 37)



Diagrami i qarkullimit
(shih faqen 32)



Pjesët e servisit (shih faqen 42)

Pajisje të posaçme

nuk përfshihet në vëllimin e furnizimit



Zgjatësi 25 mm (shih faqen 42)



set i nivelimit 1° (shih faqen 42)



Pastrimi (shih faqen 38)



Shembuj të montimit (shih faqen 32)

Dëmtim

Koka e dushit rrjedh shumë

Shkaku

- Koka e dushit e ndotur / me kalk

Ndihme

- Pastrimi / heqja e kalkut nga koka e dushit shih faqen 38



وصف الرمز

جانب المياه الباردة



ماء دافئ



يلزم هذا في النطاق وجود تقوية للحائط.



قم بسد المنفذ غير المستخدم.



تصريف



هام! لا تستخدم السليكون الذي يحتوي على أحماض!

أبعاد (راجع صفحة 37)



رسم للصرف (راجع صفحة 32)



قطع الغيار (راجع صفحة 42)



ملحقات خاصة

غير مدرج مع المحتويات المسلمة

وصلة إطالة 25 مم (راجع صفحة 42)



عدة التسوية 1° (راجع صفحة 42)



التنظيف (راجع صفحة 38)



مثال على التركيب (راجع صفحة 32)



⚠ تنبيهات الأمان

- ⚠ يجب ارتداء قفازات لليد أثناء التركيب لتجنب حدوث أضرار الإنحشار أو الجروح.
- ⚠ وظيفة ذراع دش الرأس هي فقط الإمساك بدش الرأس، ولذلك يجب عدم التحميل عليه بأشياء أخرى.
- ⚠ يسمح باستخدام الدش فقط لأغراض الإستحمام، والأغراض الصحية، وتنظيف الجسم.

تعليمات التركيب

- قبل القيام بعملية التركيب، يجب فحص المنتج للتأكد من خلوه من أية تلفيات ناتجة عن النقل. بعد القيام بعملية التركيب، لن يتم الاعتراف بوجود أية تلفيات سطحية أو تلفيات ناتجة عن عملية النقل.
- يجب تركيب وغسيل واختبار التوصيلات وخلطات المياه طبقاً للمعايير السارية.
- يجب مراعاة القواعد الخاصة بالتركيب وأعمال السباكة وفقاً للوائح الخاصة بكل بلد.
- لا يستخدم المنتج مع حمام بخار!

المواصفات الفنية

- ضغط التشغيل: الحد الأقصى 0,6 ميجاباسكال
- ضغط التشغيل الموصى به: 0,3 - 0,4 ميجاباسكال (1 ميجاباسكال = 10 بار = 147 PSI)
- درجة حرارة الماء الساخن: الحد الأقصى 60°C
- تدفق حراري: الحد الأقصى 70°C / 4 الدقيقة
- لا يمكن استعمال هذا المنتج مع سخانات الماء الفورية الهيدروليكية أو الحرارية.
- المنتج مخصص فقط لماء الشرب!

العلاج والإصلاح

- قم بتنظيف / التخلص من الجير
برأس الدش راجع صفحة 38

السبب

- رأس الدش متسخة / بها جير

العطل

رأس الدش ينفت بشكل واضح.



Biztonsági utasítások

- △ A szerelésnél a zúzódások és vágási sérülések elkerülése érdekében kesztyűt kell viselni.
- △ A zuhanyfej karja csak a zuhanyfej tartására alkalmas, és nem szabad más tárgyakkal megterhelni!
- △ A zuhanyt csak fürdő- higiéniai- és tisztítási célra szabad használni.

Szerelési utasítások

- A szerelés előtt ellenőrizni kell, hogy a terméknek nincs-e szállítási sérülése. Beépítés után a szállítási- vagy felületi sérüléseket nem ismerik el.
- A vezetékeket és a csaptelepet az érvényes szabványoknak megfelelően kell felszerelni, öblíteni és ellenőrizni
- Az egyes országokban érvényes installációs irányelveket be kell tartani.
- A terméket nem gőzfürdővel együttes használatra tervezték!

Műszaki adatok

Üzemi nyomás: max. 0,6 MPa
 Ajánlott üzemi nyomás: 0,3 - 0,4 MPa
 (1 MPa = 10 bar = 147 PSI)

Forróvíz hőmérséklet: max. 60°C
 Termikus fertőtlenítés: max. 70°C / 4 perc

Ha a zuhany működik, akkor ennek a zuhanykarral együtt kb. 10 kg a tömege. Ezért csak a falnak megfelelő rögzítő anyagot szabad használni! A mellékelt csavarok és tiplik csak tömör falakhoz használhatók.

A terméket kizárólag ivóvízhez tervezték!

Szimbólumok leírása



Hideg víz oldal



Melegvíz



Ezen a területen a fal megerősítésére van szükség.



A főlsőleges kimenetet vakdugóval kell lezárni.



Lefolyó



Ne használjon ecetsavtartalmú szilikon!



Méretet (lásd a oldalon 37)



Átfolyási diagram

(lásd a oldalon 32)



Tartozékok (lásd a oldalon 42)

Egyéb tartozék

a szállítási egység nem tartalmazza



Hosszabbítás 25 mm (lásd a oldalon 42)



szintező készlet 1° (lásd a oldalon 42)



Tisztítás (lásd a oldalon 38)



Szerelési példák (lásd a oldalon 32)

Hiba

A fejuhany erősen szivárog

Ok

- A fejuhany szennyezett / vízköves

Megoldás

- A fejuhanyt kitisztítani / vízkőtele-
níteni lásd a oldalon 38



安全上の注意

- △ 施工の際は手を挟んだり怪我をしないように、手袋をはめてください。
- △ オーバーヘッドシャワーのアームには、オーバーヘッドシャワー以外の他の物をぶら下げたり余計な力を与えないでください。
- △ シャワーは、体を洗う等の本来の目的以外では使用しないで下さい。

施工上の注意

- 製品の施工前に輸送でのダメージがないか確認してください。施工後のキズ等のお申し出はお断りさせて頂いています。
- 配管と水栓は、関連法規に従って施工、洗浄、および試験を行ってください。
- 施工行う地域に適用される関連法規をお守りください。
- この製品は、スチーム (ミスト) バス、サウナ等の高温、多湿になる場所では使用できません!

技術資料







使用圧力: 最大 0,6 MPa
 推奨使用水圧: 0,3 - 0,4 MPa
 (1 MPa = 10 bar = 147 PSI)

給湯温度: 最大 60°C
 お湯による高温消毒: 最大 70°C / 4 分

この製品は、給湯器 (電気・ガス) で使用できません。

この製品は飲料水での使用が前提となっています (日本においては水道法に適合する飲料水)!

アイコンの説明

-  水用
-  温
-  この範囲は、壁の補強が必要です。
-  未使用の取出口は、プラグで止水してください。
-  排水
-  酢酸系シリコンをご使用にならないでください!



寸法 (次のページを参照 37)

流量曲線図 (次のページを参照 32)

スペアパーツ (次のページを参照 42)

スペシャルパーツ

別手配部品

-  25 mm延長部材 (次のページを参照 42)
-  レベル調整部材セット 1° (次のページを参照 42)

お手入れ方法 (次のページを参照 38)

施工例 (次のページを参照 32)

症状	原因	対応策
オーバーヘッドシャワーから多くの水が漏れる	- オーバーヘッドシャワーの汚れ/ カルキによる故障	- オーバーヘッドシャワーを清掃/ カルキを除去してください 次の ページを参照 38



Rainmaker Select 460 3jet

2401740X

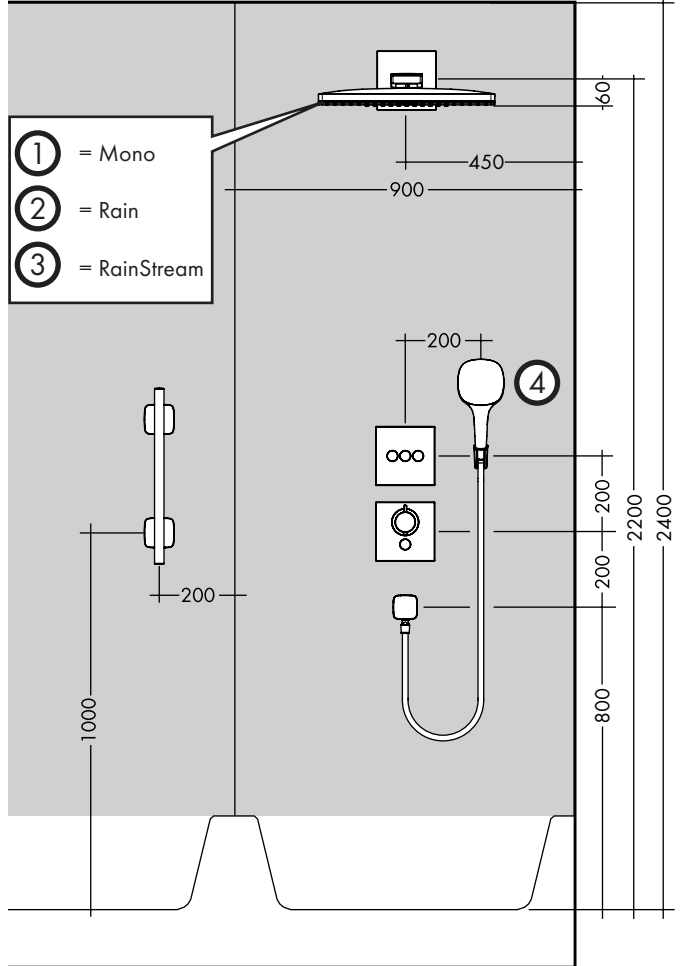
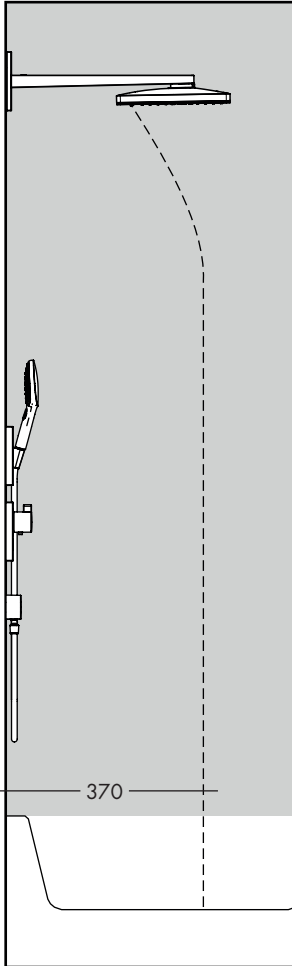
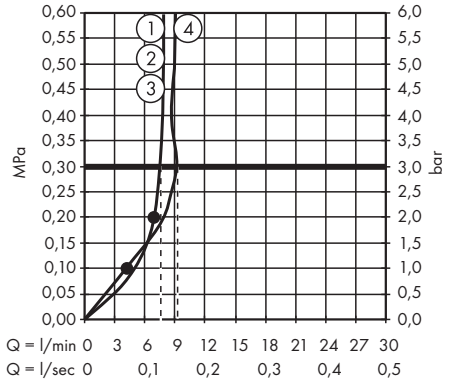

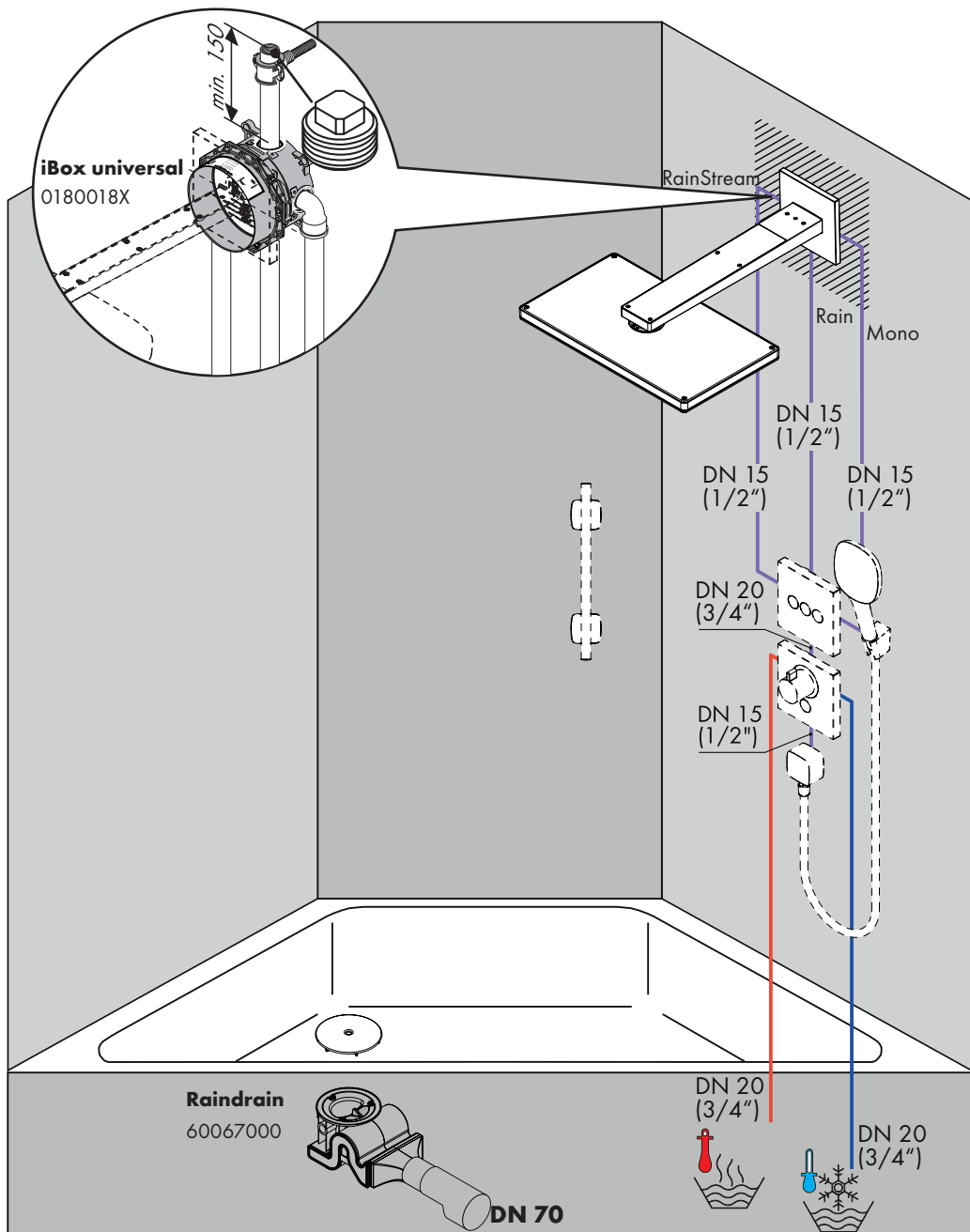



Rainmaker Select 460 2jet

2401540X

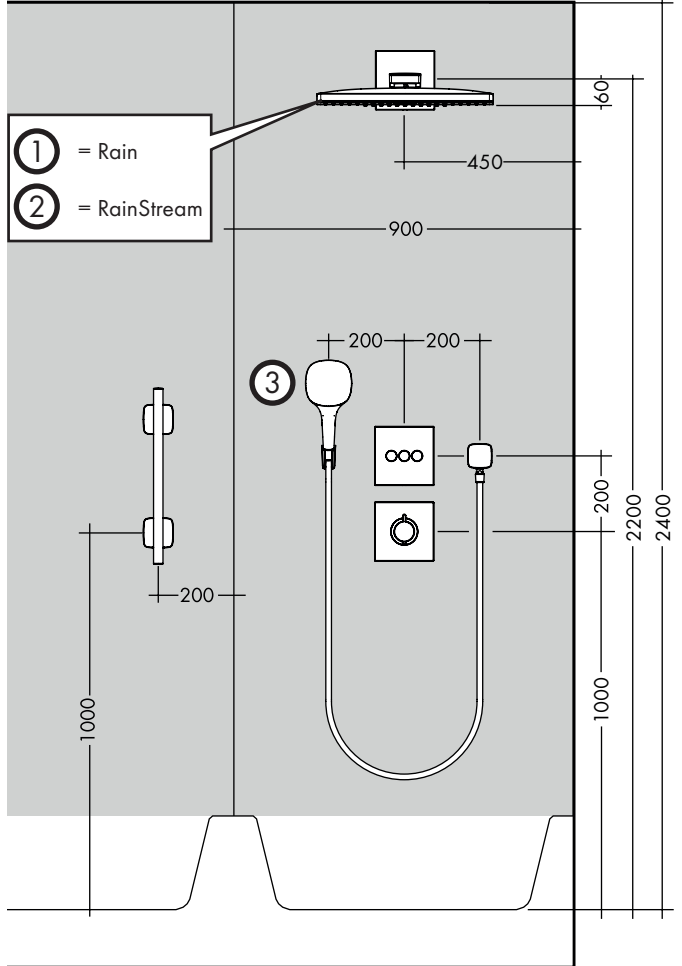
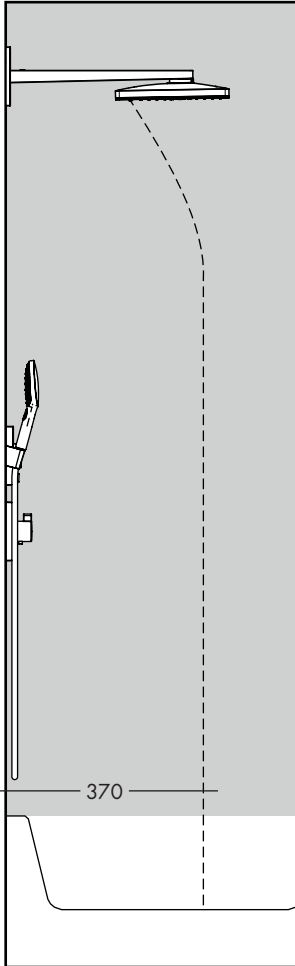
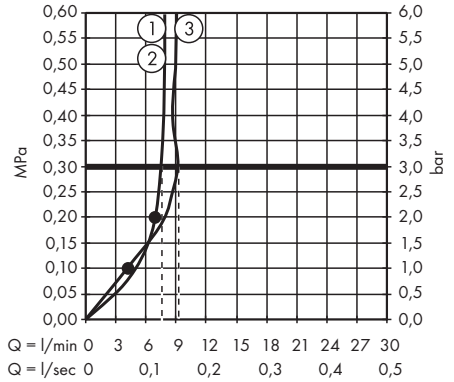

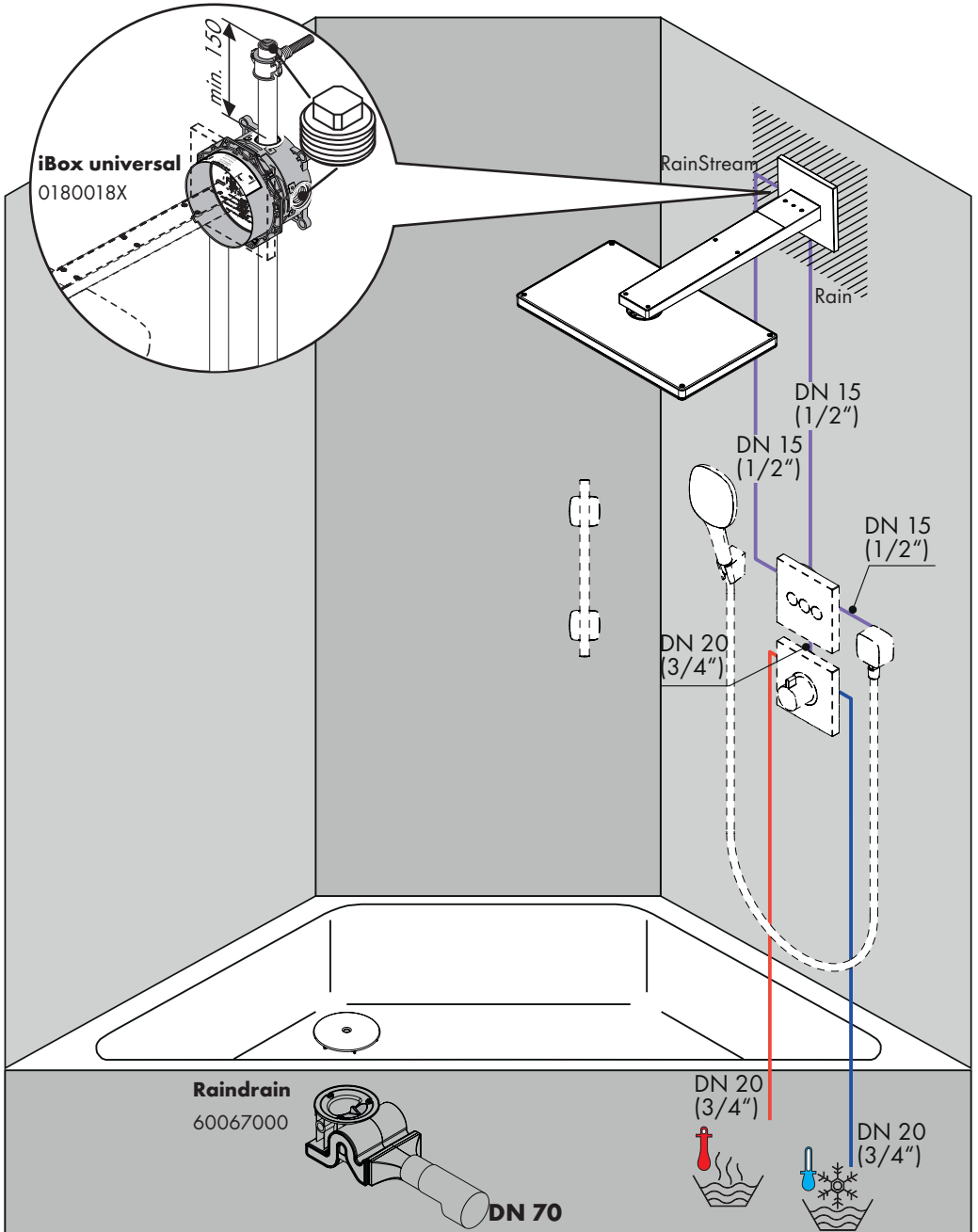

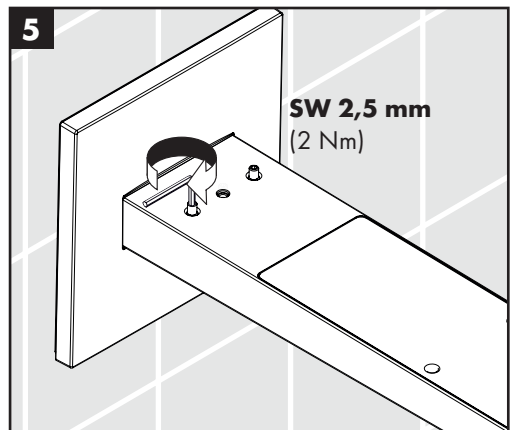
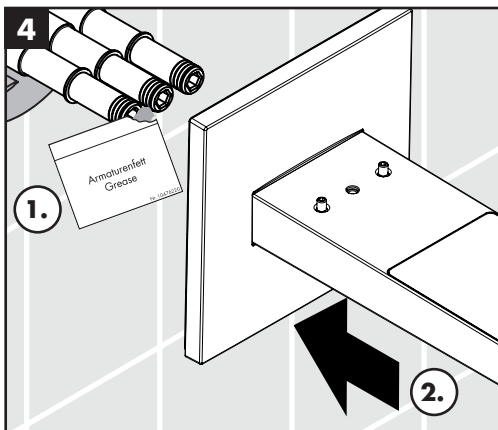
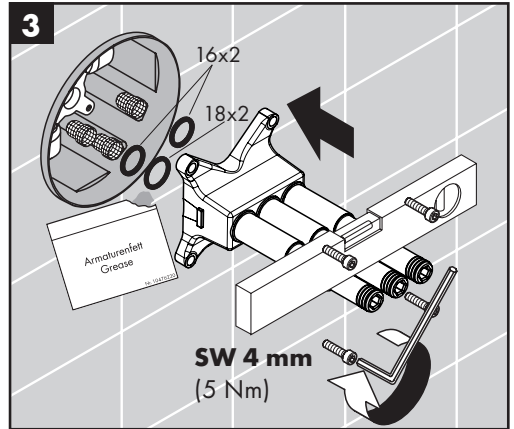
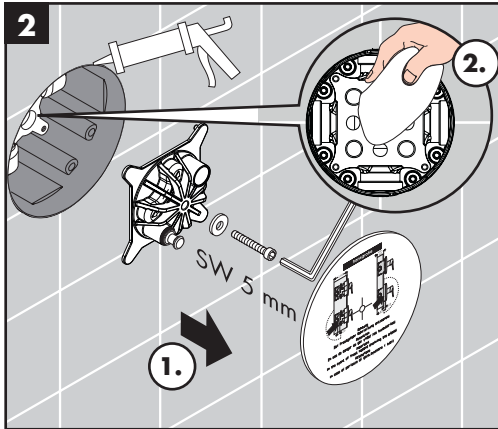
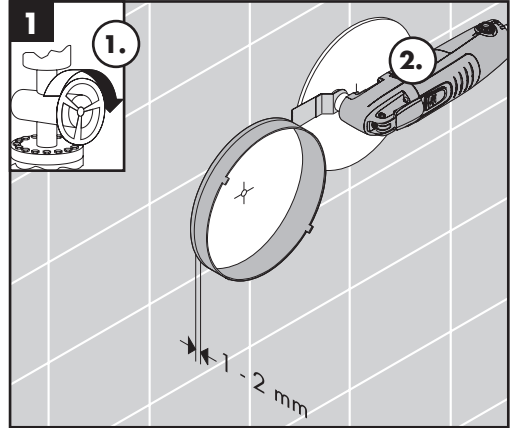
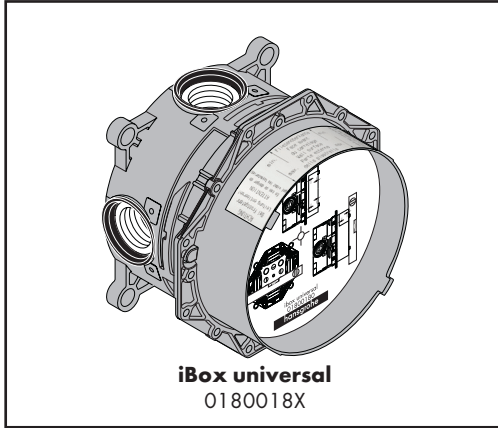

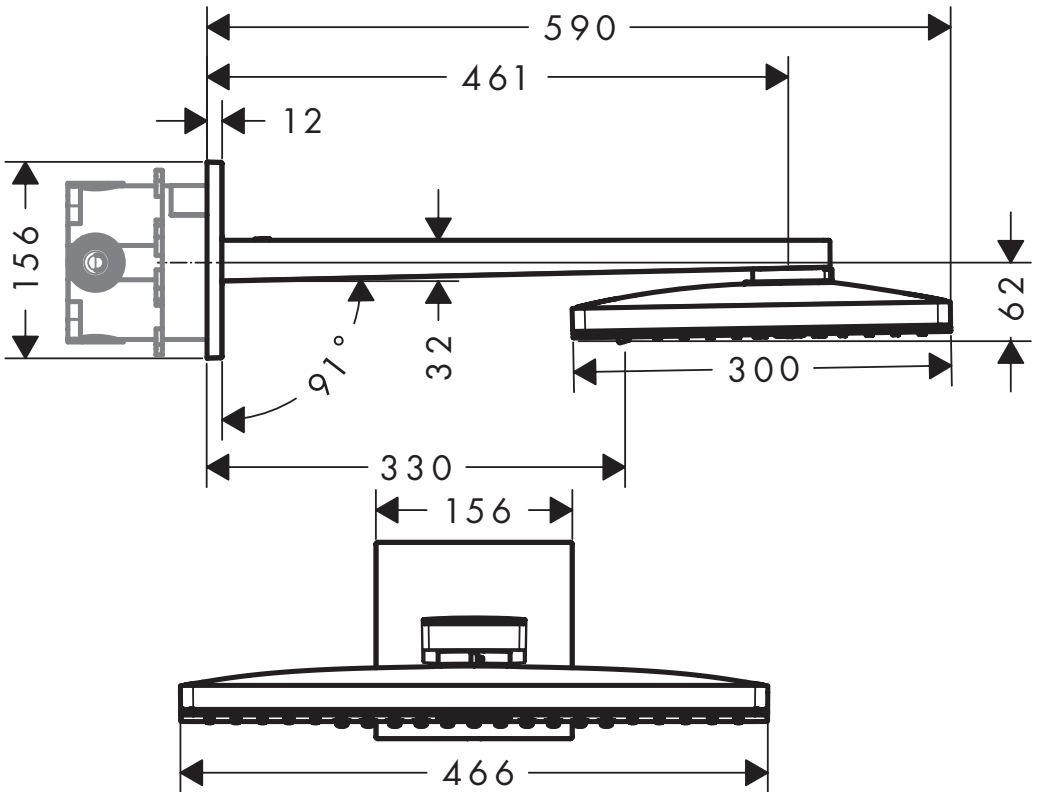
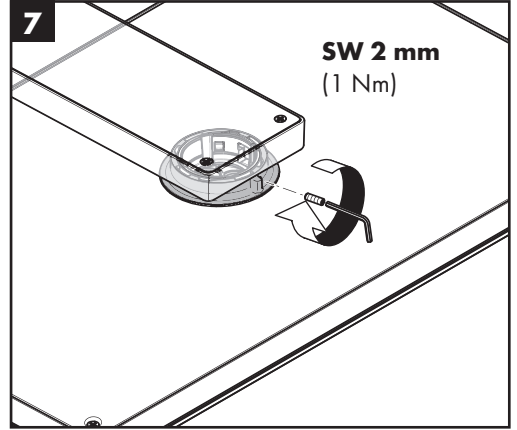
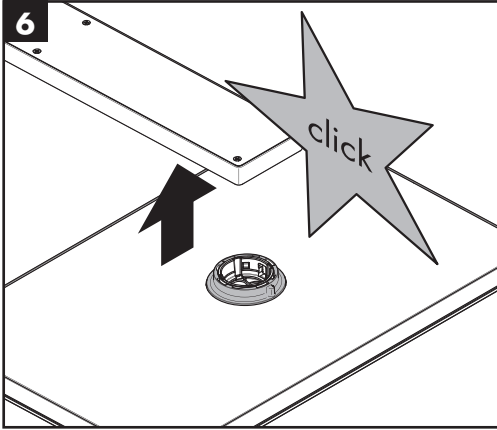



- DE** Reinigungsempfehlung / Garantie / Kontakt
- FR** Recommandation pour le nettoyage / Garanties / Contact
- EN** Cleaning recommendation / Warranty / Contact
- IT** Raccomandazione di pulizia / Garanzia / Contatto
- ES** Recomendaciones para la limpieza / Garantía / Contacto
- NL** Aanbevelingen inzake reiniging / Garantie / Contact
- DK** Rensning, anbefaling / Garanti / Kontakt
- PT** Recomendações de limpeza / Garantia / Contacto
- PL** Zalecenie dotyczące pielęgnacji / Gwarancja / Kontakt
- CS** Doporučení k čištění / Záruka / Kontakt
- SK** Odporúčania pre čistenie / Záruka / Kontakt
- ZH** 清洁指南 / 担保 / 接触
- RU** Рекомендации по очистке / Гарантия / Контакты
- FI** Puhdistussuositus / Takuu / Kosketus
- SV** Rengöringsrekommendationer / Garanti / Contacto
- LT** Valymo rekomendacijos / Garantija / Kontaktai
- HR** Preporuke za čišćenje / Garancija / Kontakt
- TR** Temizleme önerisi / Garanti / Temas
- RO** Recomandări pentru curățare / Garanție / Contact
- EL** Σύσταση καθαρισμού / Εγγύηση / επαφή
- SL** Priporočilo za čiščenje / Garancija / Kontakt
- ET** Puhastussooitused / Garantii / Kontakt
- LV** Tīrīšanas ieteikumi / Garantija / Kontakti
- SR** Preporuke za čišćenje / Garancija / Kontakt
- NO** Anbefaling for rengjøring / Garanti / Kontakt
- BG** Препоръка за почистване / Гаранция / Контакт
- SQ** Këshilla rreth pastrimit / Garancia / Kontakt
- KO** 세정시 권장사항 / 품질보증 / 접촉
- AR** توصيات التنظيف / الضمان (الولايات المتحدة الأمريكية) / اتصال
- HU** Tisztítási tanácsok / Garancia / érintkezés
- JP** お手入れの方法 / 保証について / ご連絡先



[www.hansgrohe.com/
cleaning-recommendation](http://www.hansgrohe.com/cleaning-recommendation)



[www.hansgrohe.com/
cleaning-recommendation](http://www.hansgrohe.com/cleaning-recommendation)



[www.hansgrohe.com/
cleaning-recommendation](http://www.hansgrohe.com/cleaning-recommendation)



[www.hansgrohe.com/
cleaning-recommendation](http://www.hansgrohe.com/cleaning-recommendation)

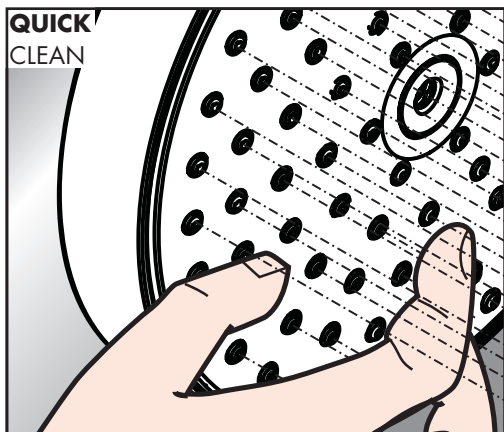

DE Einfach sauber: Kalk lässt sich von den Noppen ganz leicht abrubbeln.

FR La propreté en toute simplicité: les dépôts formés sur les buses élastiques en silicone s'éliminent par un simple passage de la main.

EN Just clean: simply rub over the spray nozzles to remove lime scale.

IT Facile da pulire: Il calcare viene eliminato semplicemente dagli ugelli elastici in silicone.

ES Fácil aseó: La cal se puede retirar sencillamente frotando con los dedos de las toberas elásticas de silicona.

NL Eenvoudig schoon: Kalk kan eenvoudig van de noppen worden gewreven.

DK Enkel rengøring: Det er let at fjerne kalkaflejringer fra stråledyserne.

PT Simplesmente limpo: o calcário pode ser simplesmente retirado das saiências através de fricção.

PL Po prostu czysto: Pęczki można całkiem łatwo oczyścić z kamienia.

CS Jednoduše čistě: Vapenné usazeniny můžete z popků snadno odstranit oříením.

SK Jednoducho čistý: Vodný kameň sa dá zo štetín celkom ľahko odstrániť.

ZH 清洁: 只需要揉搓花洒表面的出水孔即可去除水垢。

RU Простота чистки: известь очень легко стирается с утолщений.

FI Yksinkertaisesti puhdas: kalkin voi helposti hieroa irti nypystä.

SV Enkelt att göra rent: det är lätt att ta bort kalk från nopporna.

LT Paprasta švara: kalkės lengvai nugrandomos nuo kilpos.

HR Jednostavno čisto: Kamenac se sasvim lako uklanja s izbočina.

TR Sadece temiz: Kireç, düğümlemlerle kolayca ovalanabilir.

RO Pur și simplu curat: Calcarul se îndepărtează ușor de pe noduri prin frecare.

EL Απλά τέλεια καθαριότητα: Τα άλατα μπορούν να αφαιρεθούν με μεγάλη ευκολία από τα στόμια.

SL Preprosto čisto: arpenec se z lahkoto podrgne z vozličkov.

ET Lihtsalt puhas: lupja saab nuppudelgi lihtsalt maha hõõruda.

LV Vienkārša tīrīšana: kaļķis no izvirzījumiem ir viegli norubināms.

SR Jednostavno čisto: Kamenac se sasvim lako skida sa izbočina.

NO Simpelten ren: Ved å gnikke er det lett å fjerne kalk fra nuppene.

BG Просто чисто: Варовикът лесно може да се изтърси от удебеленията.

SQ Thjesht dhe pastër. Mbetjet gëlqerore mund të hiqen me fërkim të lehtë.

AR إنه سهل التنظيف، حيث يسقط الجير بسهولة شديدة من الأجزاء الناتئة

HU Egyszerűen tiszta: a vízkő egészen könnyen ledörzöslhető a csomókról.

JP 清掃が簡単: カルキは突起部から簡単にこすり落とすことができます。

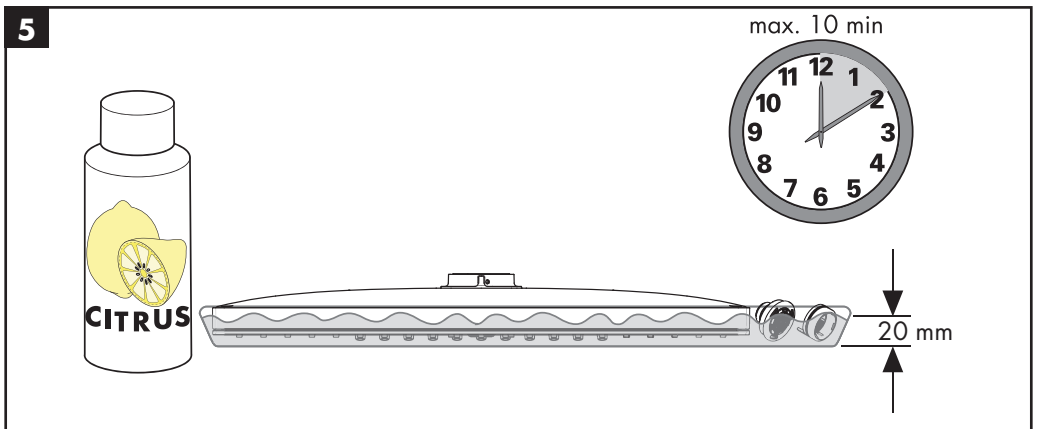
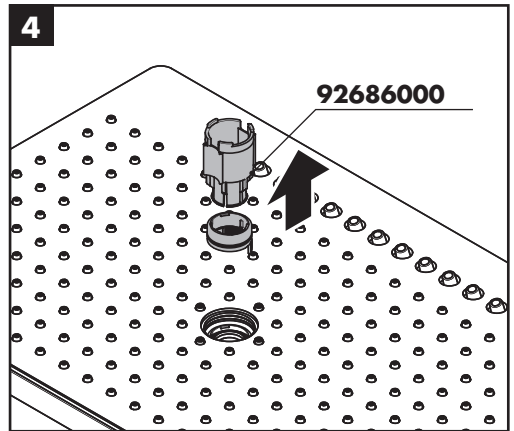
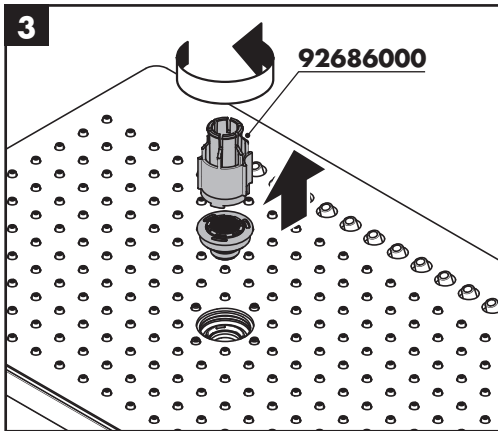
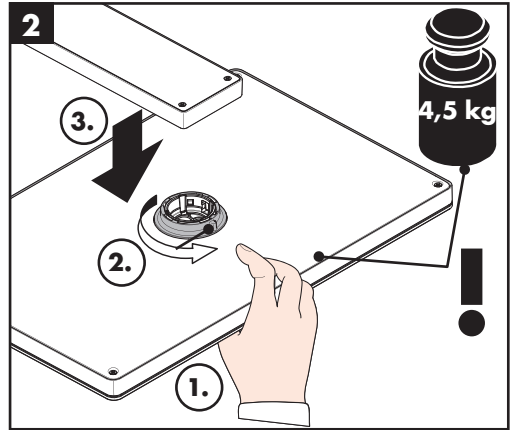
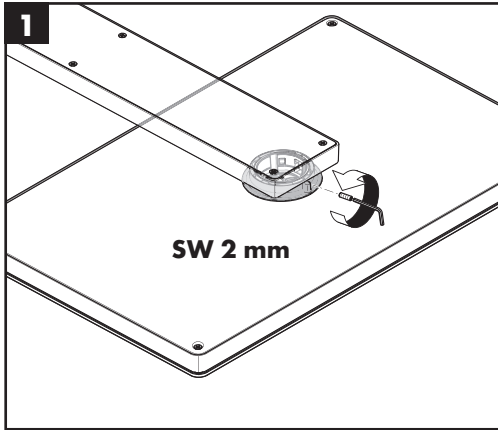

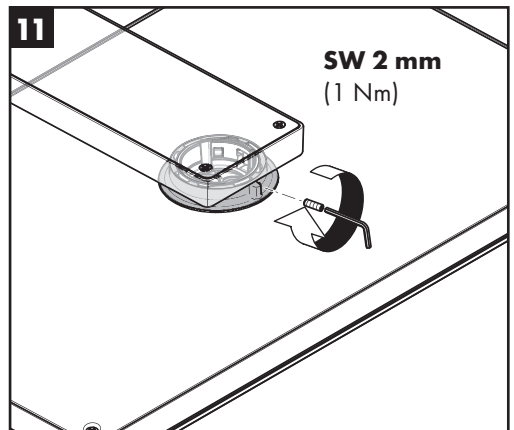
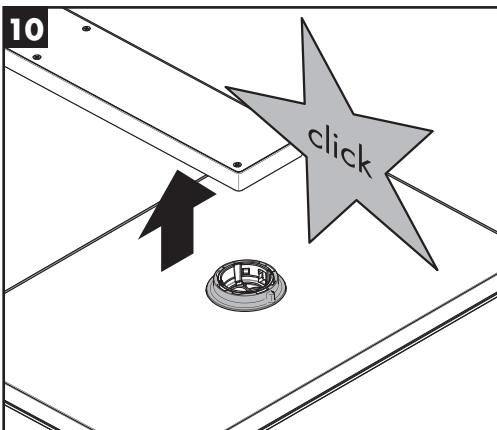
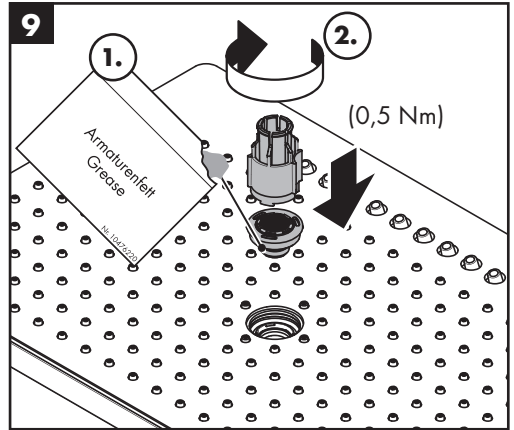
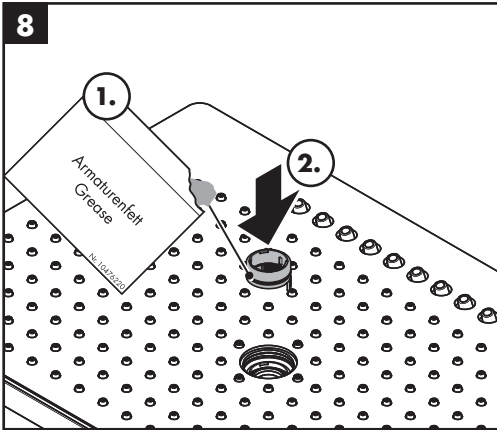
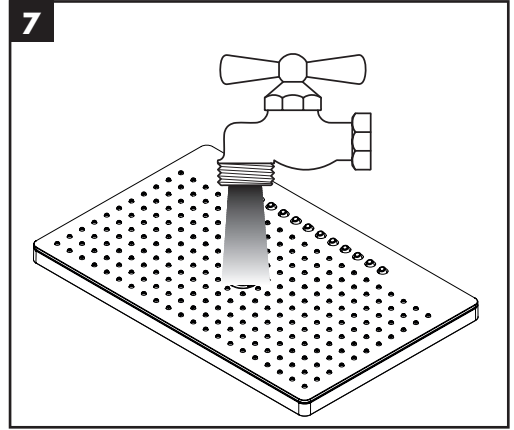
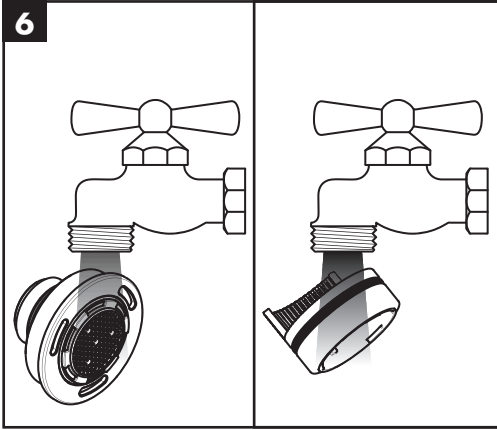



Rainmaker Select 460 2jet

2401540X

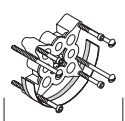
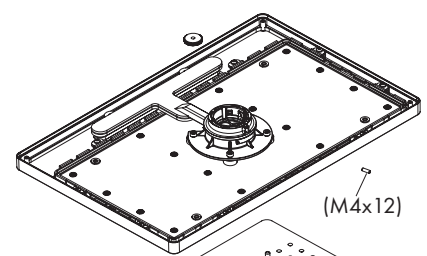
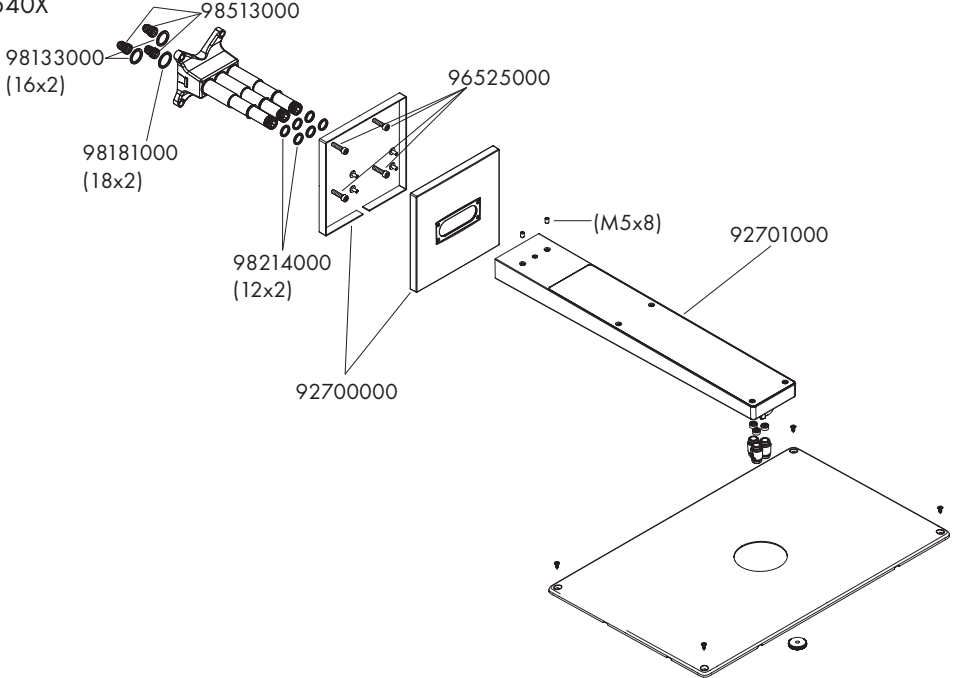

13595000
(25 mm)

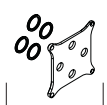

95521000
(1°)

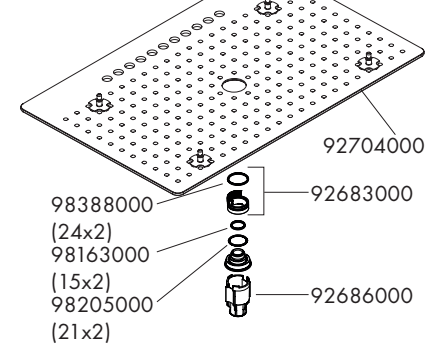



Rainmaker Select 460 3jet

2401740X

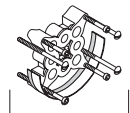
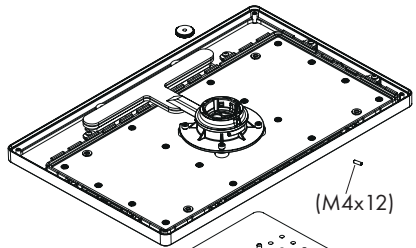
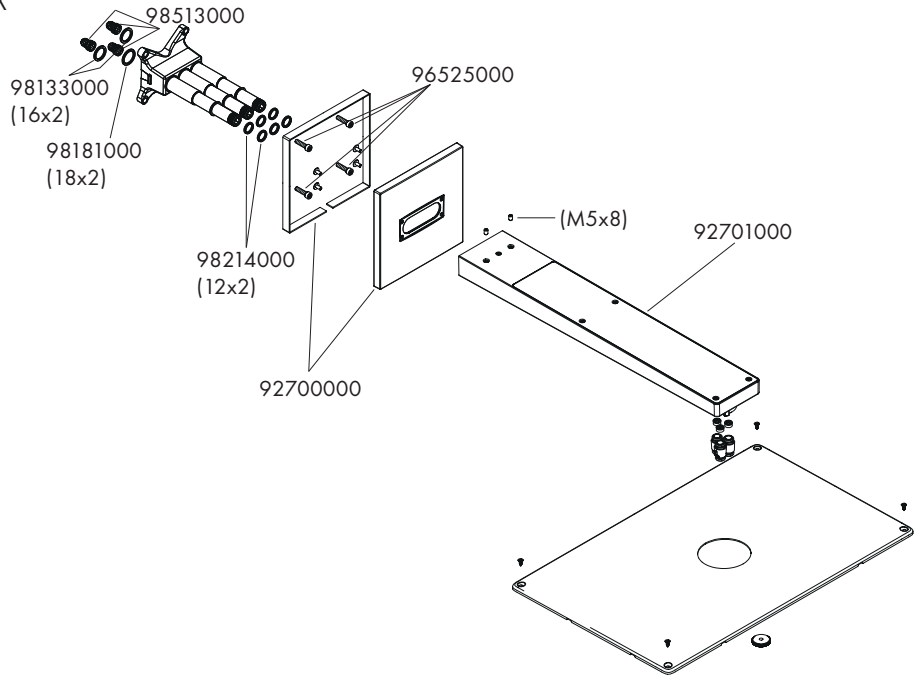

13595000
(25 mm)

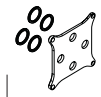

95521000
(1°)

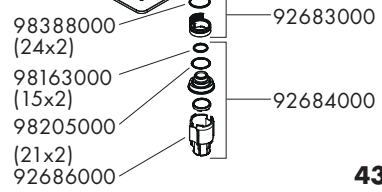
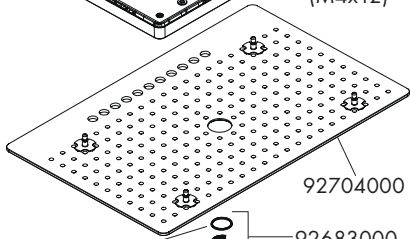

hansgrohe

Hansgrohe · Auestraße 5 · 9 · D-77761 Schiltach · Telefon +49 (0) 78 36/51-1282 · Telefax +49 (0) 7836/511440
E-Mail: info@hansgrohe.com · Internet: www.hansgrohe.com

03/2020
9.041.50.01