

hansgrohe

- DE** Montageanleitung
- FR** Instructions de montage
- EN** Assembly instructions
- IT** Istruzioni per Installazione
- ES** Instrucciones de montaje
- NL** Handleiding
- DK** Monteringsvejledning
- PT** Manual de Instalação
- PL** Instrukcja montażu
- CS** Montážní návod
- SK** Montážny návod
- ZH** 组装说明
- RU** Инструкция по монтажу
- HU** Szerelési útmutató
- FI** Asennusohje
- SV** Monteringsanvisning
- LT** Montavimo instrukcijos
- HR** Uputstva za instalaciju
- TR** Montaj kılavuzu
- RO** Instrucțiuni de montare
- EL** Οδηγία συναρμολόγησης
- SL** Navodila za montažo
- ET** Paigaldusjuhend
- LV** Montāžas instrukcija
- SR** Uputstvo za montažu
- NO** Montasjeveiledning
- BG** Инструкция за употреба
- SQ** Udhëzime rreth montimit
- AR** تعليمات التجميع
- JP** 施工説明書

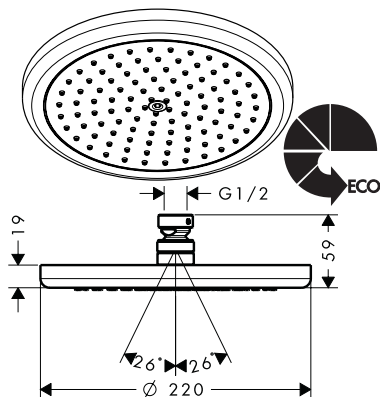

Croma 220 Air 1jet
26465XXX

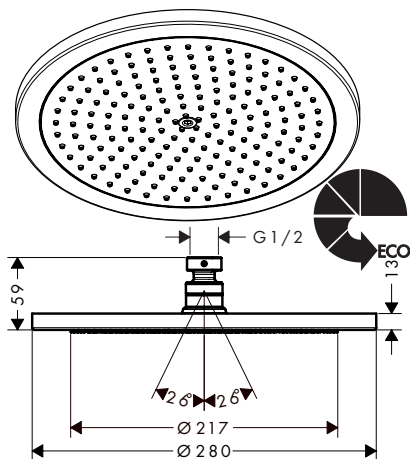

Croma 280 Air 1jet
26221XXX

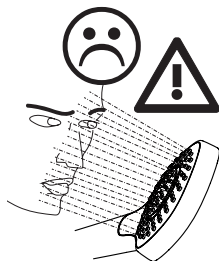
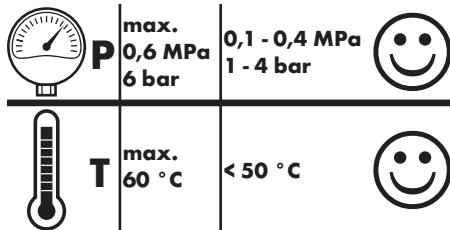

Croma 220 Air 1jet 26465XXX

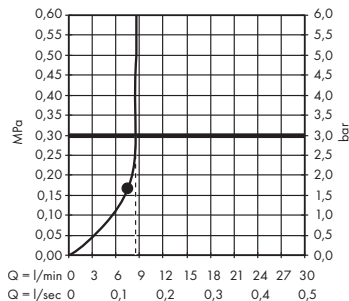

Croma 280 Air 1jet 26221XXX

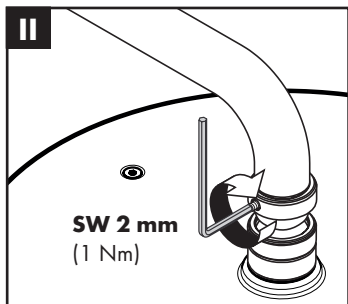
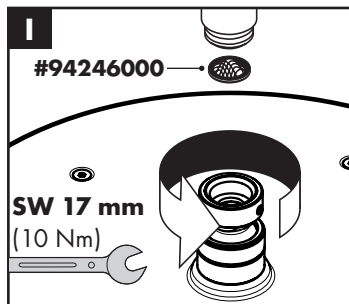
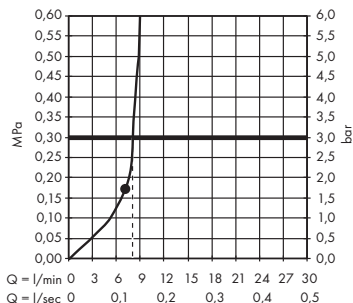

Service

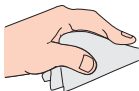

#95795000

A - D

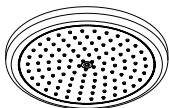

#26465XXX

#26221XXX

1 - 6

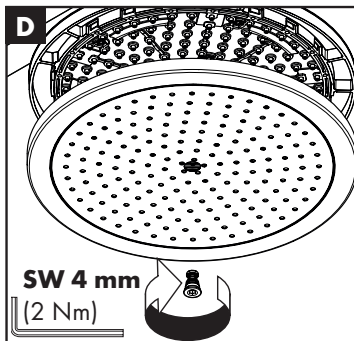
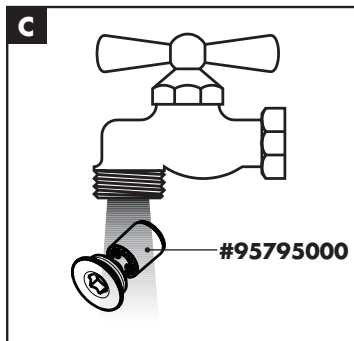
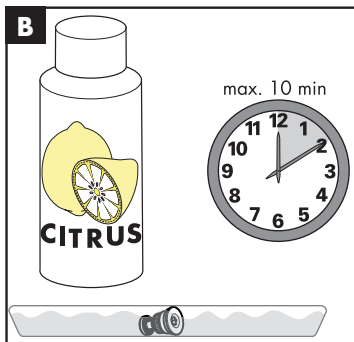
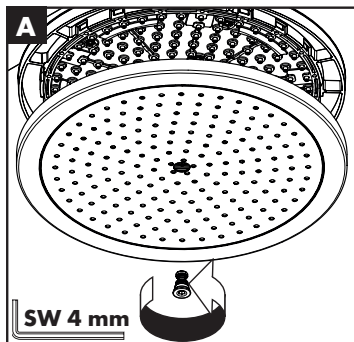

Service

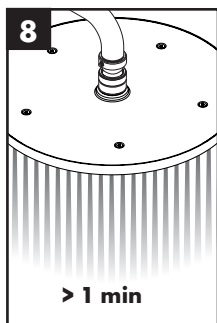
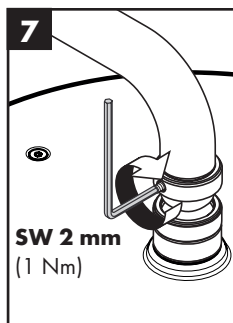
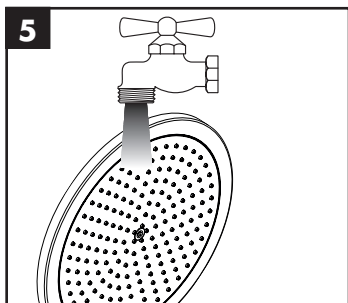
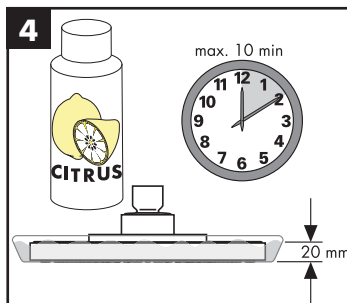
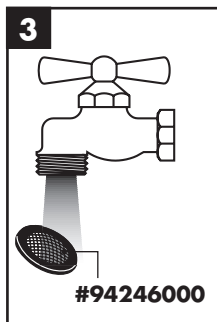
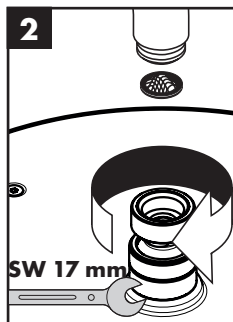
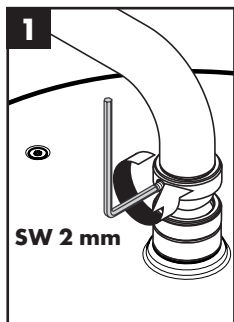

- DE** Reinigungsempfehlung / Garantie / Kontakt
FR Recommandation pour le nettoyage / Garanties / Contact
EN Cleaning recommendation / Warranty / Contact
IT Raccomandazione di pulizia / Garanzia / Contatto
ES Recomendaciones para la limpieza / Garantía / Contacto
NL Aanbevelingen inzake reiniging / Garantie / Contact
DK Rengøringsvejledning / Garanti / Kontakt
PT Recomendações de limpeza / Garantia / Contacto
PL Zalecenie dotyczące pielęgnacji / Gwarancja / Kontakt
CS Doporučení k čištění / Záruka / Kontakt
SK Odporúčania pre čistenie / Záruka / Kontakt
ZH 清洁指南 / 担保 / 接触
RU Рекомендации по очистке / Гарантия / Контакты
FI Puhdistussuositus / Takuu / Kosketus
SV Rengöringsrekommendationer / Garanti / Contacto
LT Valymo rekomendacijos / Garantija / Kontaktai
HR Preporuke za čišćenje / Garancija / Kontakt
TR Temizleme önerisi / Garanti / Temas
RO Recomandări pentru curățare / Garanție / Contact
EL Σύσταση καθαρισμού / Εγγύηση / επαφή
SL Priporočilo za čiščenje / Garancija / Kontakt
ET Puhastussuositused / Garantii / Kontakt
LV Tīrīšanas ieteikumi / Garantija / Kontakti
SR Preporuke za čišćenje / Garancija / Kontakt
NO Anbefaling for rengjøring / Garanti / Kontakt
BG Препоръка за почистване / Гаранция / Контакт
SQ Këshilla rreth pastrimit / Garancia / Kontakt
KO 세정시 권장사항 / 품질보증 / 접촉
AR توصيات التنظيف / الضمان (الولايات المتحدة الأمريكية) / اتصال
HU Tisztítási tanácsok / Garancia / érintkezés
JP お手入れの方法 / 保証について / ご連絡先



www.hansgrohe.com/cleaning-recommendation

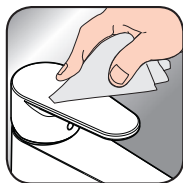

www.hansgrohe.com/cleaning-recommendation



www.hansgrohe.com/cleaning-recommendation



www.hansgrohe.com/cleaning-recommendation

- DE** Einfach sauber: Kalk lässt sich von den Noppen ganz leicht abrubbeln.
- FR** La propreté en toute simplicité: les dépôts formés sur les buses élastiques en silicone s'éliminent par un simple passage de la main.
- EN** Just clean: simply rub over the spray nozzles to remove lime scale.
- IT** Facile da pulire: Il calcare viene eliminato semplicemente dagli ugelli elastici in silicone.
- ES** Fácil asear: La cal se puede retirar sencillamente frotando con los dedos de las toberas elásticas de silicona.
- NL** Eenvoudig schoon: Kalk kan eenvoudig van de noppen worden gewreven.
- DK** Enkel rengøring: Det er let at fjerne kalkaflejring fra stråledyserne.
- PT** Simplesmente limpo: o calcário pode ser simplesmente retirado das saliências através de fricção.
- PL** Po prostu czysto: Pęczki można całkiem łatwo oczyścić z kamienia.
- CS** Jednoduše čistě: Vapenné usazeniny můžete z noplek snadno odstranit ořením.
- SK** Jednoducho čistý: Vodný kameň sa dá zo štetín celkom ľahko odstrániť.
- ZH** 清洁: 只需要揉搓花洒表面的出水孔即可去除水垢。
- RU** Простота чистки: известь очень легко стирается с утолщений.
- FI** Yksinkertaisesti puhdas: kalkin voi helposti hieroa irti nuppystä.
- SV** Enkelt att göra rent: det är lätt att ta bort kalk från nopporna.
- LT** Paprasta švara: kalkės lengvai nugarandomos nuo kilpos.
- HR** Jednostavno čisto: Kamenac se sasvim lako uklanja s izbočina.

- TR** Sadece temiz: Kireç, düğümlemlerle kolayca ovalanabilir.
- RO** Pur și simplu curat: Calcarul se îndepărtează ușor de pe noduri prin frecare.
- EL** Απλά τέλεια καθαριότητα: Τα άλάτα μπορούν να αφαιρεθούν με μεγάλη ευκολία από τα στόμια.
- SL** Preprosto čisto: arnenec se z lahkoto podrgne z vozličkov.
- ET** Lihtsalt puhas: lujja saab nuppuheld lihtsalt maha hõõruda.
- LV** Vienkārša tīrīšana: kalķis no izvirzījumiem ir viegli norubināms.
- SR** Jednostavno čisto: Kamenac se sasvim lako skida sa izbočina.
- NO** Simpelten ren: Ved å gnikke er det lett å fjerne kalk fra nuppene.
- BG** Просто чисто: Варовикът лесно може да се изтръси от удебеленията.
- SQ** Thjesht dhe pastër. Mbetjet gëlqerore mund të hiqen me fërkim të lehtë.
- AR** إنه سهل التنظيف، حيث يسقط الجير بسهولة شديدة من الأجزاء الناتئة
- HU** Egyszerűen tiszta: a vízkő egészen könnyen ledörzsölhető a csomókról.
- JP** 清掃が簡単: カルキは突起部から簡単にこすり落とすことができます。

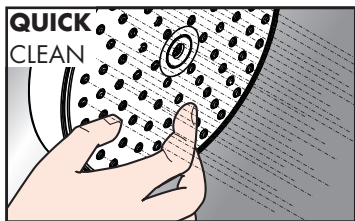

hansgrohe

Hansgrohe · Austraße 5 · 9 · D-77761 Schiltach
 Telefon +49 (0) 78 36/51-1282 · Telefax +49 (0) 7836/511440
 E-Mail: info@hansgrohe.com · Internet: www.hansgrohe.com