

# Solid Tantalum Surface Mount Chip Capacitors

## TANTAMOUNT<sup>®</sup>, Molded Case, Standard Industrial Grade

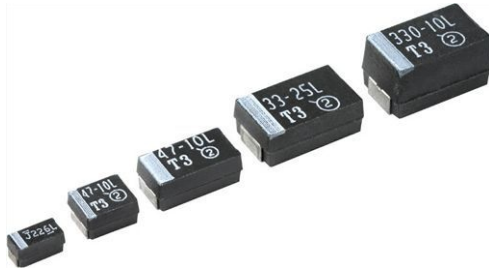

### PERFORMANCE/ELECTRICAL CHARACTERISTICS

[www.vishay.com/doc?40088](http://www.vishay.com/doc?40088)

**Operating Temperature:** -55 °C to +125 °C  
(above 85 °C, voltage derating is required)

**Capacitance Range:** 0.10 μF to 1000 μF

**Capacitance Tolerance:** ± 5 %, ± 10 %, ± 20 %

**100 % Surge Current Tested (D and E Case Codes)**

**Voltage Rating:** 4 V<sub>DC</sub> to 75 V<sub>DC</sub>

### FEATURES

- Molded case available in six case codes
- Terminations: 100 % matte tin, standard, tin/lead available
- Compatible with “High Volume” automatic pick and place equipment
- Meets EIA-535-BAAC mechanical and performance requirements
- Qualified to EIA-717
- Moisture sensitivity level 1
- Optical character recognition qualified
- Compliant terminations
- Material categorization: For definitions of compliance please see [www.vishay.com/doc?99912](http://www.vishay.com/doc?99912)



### Note

\* This datasheet provides information about parts that are RoHS-compliant and/or parts that are non-RoHS-compliant. For example, parts with lead (Pb) terminations are not RoHS-compliant. Please see the information/tables in this datasheet for details.

### APPLICATIONS

- Industrial
- Telecom infrastructure
- General purpose

ORDERING INFORMATION					
293D	107	X9	010	D	2WE3
TYPE	CAPACITANCE	CAPACITANCE TOLERANCE	DC VOLTAGE RATING AT +85 °C	CASE CODE	TERMINATION AND PACKAGING
	This is expressed in picofarads. The first two digits are the significant figures. The third is the number of zeros to follow.	X0 = ± 20 % X9 = ± 10 % X5 = ± 5 % (special order)	This is expressed in V. To complete the three-digit block, zeros precede the voltage rating. A decimal point is indicated by an “R” (6R3 = 6.3 V).	See Ratings and Case Codes table	2TE3: Matte tin, 7" (178 mm) reel 2WE3: Matte tin, 13" (330 mm) reel 8T: Tin/lead, 7" (178 mm) reel 8W: Tin/lead, 13" (330 mm) reel

### Notes

- We reserve the right to supply higher voltage ratings and tighter capacitance tolerance capacitors in the same case size. Voltage substitutions will be marked with the higher voltage rating.
- We reserve the right to supply better series with more extensive screening.
- Dry pack is available per request, contact regional marketing.

DIMENSIONS in inches [millimeters]							
CASE CODE	EIA SIZE	L	W	H	P	Tw	Th (MIN.)
A	3216-18	0.126 ± 0.008 [3.2 ± 0.20]	0.063 ± 0.008 [1.6 ± 0.20]	0.063 ± 0.008 [1.6 ± 0.20]	0.031 ± 0.012 [0.80 ± 0.30]	0.047 ± 0.004 [1.2 ± 0.10]	0.028 [0.70]
B	3528-21	0.138 ± 0.008 [3.5 ± 0.20]	0.110 ± 0.008 [2.8 ± 0.20]	0.075 ± 0.008 [1.9 ± 0.20]	0.031 ± 0.012 [0.80 ± 0.30]	0.087 ± 0.004 [2.2 ± 0.10]	0.028 [0.70]
C	6032-28	0.236 ± 0.012 [6.0 ± 0.30]	0.126 ± 0.012 [3.2 ± 0.30]	0.098 ± 0.012 [2.5 ± 0.30]	0.051 ± 0.012 [1.3 ± 0.30]	0.087 ± 0.004 [2.2 ± 0.10]	0.039 [1.0]
D	7343-31	0.287 ± 0.012 [7.3 ± 0.30]	0.169 ± 0.012 [4.3 ± 0.30]	0.110 ± 0.012 [2.8 ± 0.30]	0.051 ± 0.012 [1.3 ± 0.30]	0.094 ± 0.004 [2.4 ± 0.10]	0.039 [1.0]
E	7343-43	0.287 ± 0.012 [7.3 ± 0.30]	0.169 ± 0.012 [4.3 ± 0.30]	0.157 ± 0.012 [4.0 ± 0.30]	0.051 ± 0.012 [1.3 ± 0.30]	0.094 ± 0.004 [2.4 ± 0.10]	0.039 [1.0]
V	7343-20	0.287 ± 0.012 [7.3 ± 0.30]	0.169 ± 0.012 [4.3 ± 0.30]	0.079 max [2.0 max]	0.051 ± 0.012 [1.3 ± 0.30]	0.094 ± 0.004 [2.4 ± 0.10]	0.039 [1.0]

### Note

- Glue pad (non-conductive, part of molded case) is dedicated for glue attachment (as user option).

RATINGS AND CASE CODES										
μF	4 V	6.3 V	10 V	16 V	20 V	25 V	35 V	50 V	63 V	75 V
0.10						A	A	A		A <sup>(1)</sup>
0.15							A	A/B		B <sup>(1)</sup>
0.22							A	A/B		B <sup>(1)</sup>
0.33						A	A	A/B		B <sup>(1)</sup>
0.47			A		A	A	A/B	A/B/C		B <sup>(1)</sup>
0.68				A	A	A	A/B	B/C		C <sup>(1)</sup>
1.0			A	A	A/B	A/B	A/B	B/C		D <sup>(1)</sup>
1.5		A	A	A/B	A/B	A/B	B/C	B/C/D		D <sup>(1)</sup>
2.2	A	A	A/B	A/B	A/B	A/B/C	B/C	B/C/D		D <sup>(1)</sup>
3.3	A	A/B	A/B	A/B	A/B/C	A/B/C	B/C/D	C/D		D <sup>(1)</sup>
4.7	A/B	A/B	A/B/C	A/B/C	A/B/C	A/B/C/D	B/C/D	C/D/E	D	E
6.8	A/B	A/B	A/B/C	A/B/C	A/B/C	B/C/D	C/D	D/E		
10	A/B	A/B/C	A/B/C	A/B/C/D	B/C/D	B/C/D	C/D	D/E	E	
15	A/B/C	A/B/C	A/B/C	B/C	B/C/D	B/C/D	D/E	E		
22	A/B/C	A/B/C	A/B/C/D	B/C/D	B/C/D	C/D/E/V	D/E			
33	A/B/C	A/B/C	B/C/D	B/C/D	C/D	D/E				
47	A/B/C	A/B/C/D	B/C/D	C/D/E	D/E	D/E				
68	B/C/D	B/C/D	B/C/D/E/V	D/E	D/E	E				
100	A/B/C/D	B/C/D/E	B/C/D/E/V	D/E/V	D/E					
120	D	D	E							
150	B/C/D	C/D/E	C/D/E	D/E						
220	B/C/D/E	C/D/E	D/E/V	E						
330	D/E	D/E	D/E							
470	D/E	D/E	E							
680	D/E	E								
1000	E	E								

**Note**

<sup>(1)</sup> Rating in development, contact factory for availability.

MARKING																				
<p><b>A Case</b></p>	<p><b>“A” CASE VOLTAGE CODE</b></p> <table border="1"> <thead> <tr> <th>VOLTS</th> <th>CODE</th> </tr> </thead> <tbody> <tr><td>4.0</td><td>G</td></tr> <tr><td>6.3</td><td>J</td></tr> <tr><td>10</td><td>A</td></tr> <tr><td>16</td><td>C</td></tr> <tr><td>20</td><td>D</td></tr> <tr><td>25</td><td>E</td></tr> <tr><td>35</td><td>V</td></tr> <tr><td>50</td><td>T</td></tr> </tbody> </table>	VOLTS	CODE	4.0	G	6.3	J	10	A	16	C	20	D	25	E	35	V	50	T	<p><b>B, C, D, E, V Cases</b></p>
	VOLTS	CODE																		
4.0	G																			
6.3	J																			
10	A																			
16	C																			
20	D																			
25	E																			
35	V																			
50	T																			
<p><b>Marking</b></p> <p>Capacitor marking includes an anode (+) polarity band, capacitance in microfarads and the voltage rating. “A” Case capacitors use a letter code for the voltage and EIA capacitance code.</p> <p>The Vishay Sprague® trademark is included if space permits. Capacitors rated at 6.3 V are marked 6 V.</p> <p>A manufacturing date code is marked on all capacitors.</p> <p>Capacitors may bear TP3 marking scheme if parts are substituted with high performance automotive grade TP3 family products. This includes, for example, letter “P” as shown below.</p> <p>Call the factory for further explanation.</p>																				

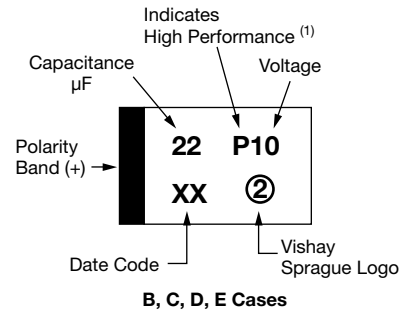
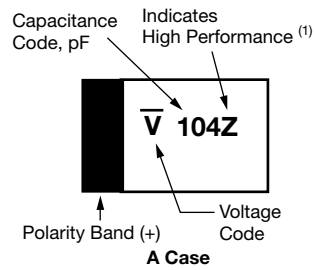
**TP3 MARKING EXAMPLE**

**Note**

<sup>(1)</sup> Capital letter indicates lead (Pb)-free.

**STANDARD RATINGS**

CAPACITANCE ( $\mu$ F)	CASE CODE	PART NUMBER	MAX. DCL AT +25 °C ( $\mu$ A)	MAX. DF AT +25 °C 120 Hz (%)	MAX. ESR AT +25 °C 100 kHz ( $\Omega$ )	MAX. RIPPLE 100 kHz $I_{RMS}$ (A)
<b>4 V<sub>DC</sub> AT +85 °C; 2.7 V<sub>DC</sub> AT +125 °C</b>						
2.2	A	293D225(1)004A(2)	0.5	6	7.60	0.10
3.3	A	293D335(1)004A(2)	0.5	6	7.60	0.10
4.7	A	293D475(1)004A(2)	0.5	6	6.30	0.11
4.7	B	293D475(1)004B(2)	0.5	6	7.00	0.11
6.8	A	293D685(1)004A(2)	0.5	6	5.50	0.12
6.8	B	293D685(1)004B(2)	0.5	6	3.40	0.16
10	A	293D106(1)004A(2)	0.5	6	5.10	0.12
10	B	293D106(1)004B(2)	0.5	6	3.50	0.16
15	A	293D156(1)004A(2)	0.6	6	3.40	0.15
15	B	293D156(1)004B(2)	0.6	6	2.90	0.17
15	C	293D156(1)004C(2)	0.6	6	2.80	0.20
22	A	293D226(1)004A(2)	0.9	6	2.90	0.16
22	B	293D226(1)004B(2)	0.9	6	2.50	0.18
22	C	293D226(1)004C(2)	0.9	6	1.80	0.25
33	A	293D336(1)004A(2)	1.3	6	2.90	0.16
33	B	293D336(1)004B(2)	1.3	6	2.00	0.21
33	C	293D336(1)004C(2)	1.3	6	1.80	0.25
47	A	293D476(1)004A(2)	1.9	14	2.50	0.17
47	B	293D476(1)004B(2)	1.9	6	1.90	0.21
47	C	293D476(1)004C(2)	1.9	6	1.80	0.25
68	B	293D686(1)004B(2)	2.7	6	1.90	0.21
68	C	293D686(1)004C(2)	2.7	6	1.40	0.28
68	D	293D686(1)004D(2)	2.7	6	0.80	0.43
100	A	293D107X0004A(2)	10.0	30	2.50	0.22
100	B	293D107(1)004B(2)	4.0	8	1.80	0.22
100	C	293D107(1)004C(2)	4.0	6	0.80	0.37
100	D	293D107(1)004D(2)	4.0	6	0.70	0.46
120	D	293D127(1)004D(2)	4.8	6	0.60	0.51
150	B	293D157(1)004B(2)	6.0	14	1.60	0.23
150	C	293D157(1)004C(2)	6.0	12	0.70	0.40
150	D	293D157(1)004D(2)	6.0	8	0.60	0.50

**Notes**

- Part number definitions:
  - Tolerance: X0, X9
  - Terminations and packaging: 2TE3, 2WE3, 8T, 8W
  - Lead (Pb)-free terminations and packaging codes: 2TE3, 2WE3
- Rating in development, contact factory for availability.



STANDARD RATINGS						
CAPACITANCE ( $\mu$ F)	CASE CODE	PART NUMBER	MAX. DCL AT +25 °C ( $\mu$ A)	MAX. DF AT +25 °C 120 Hz (%)	MAX. ESR AT +25 °C 100 kHz ( $\Omega$ )	MAX. RIPPLE 100 kHz $I_{RMS}$ (A)
<b>4 V<sub>DC</sub> AT +85 °C; 2.7 V<sub>DC</sub> AT +125 °C</b>						
220	B	293D227X0004B(2)	8.8	18	1.50	0.24
220	C	293D227(1)004C(2)	8.8	8	0.70	0.40
220	D	293D227(1)004D(2)	8.8	8	0.60	0.50
220	E	293D227(1)004E(2)	8.8	8	0.50	0.57
330	D	293D337(1)004D(2)	13.2	8	0.60	0.50
330	E	293D337(1)004E(2)	13.2	8	0.50	0.57
470	D	293D477(1)004D(2)	18.8	10	0.60	0.50
470	E	293D477(1)004E(2)	18.8	10	0.50	0.57
680	D	293D687X0004D(2)	27.2	25	0.20	0.87
680	E	293D687(1)004E(2)	27.2	12	0.50	0.57
1000	E	293D108X0004E(2)	40.0	20	0.50	0.57
<b>6.3 V<sub>DC</sub> AT +85 °C; 4 V<sub>DC</sub> AT +125 °C</b>						
1.5	A	293D155(1)6R3A(2)	0.5	6	2.90	0.16
2.2	A	293D225(1)6R3A(2)	0.5	6	7.60	0.10
3.3	A	293D335(1)6R3A(2)	0.5	6	6.30	0.11
3.3	B	293D335(1)6R3B(2)	0.5	6	5.50	0.12
4.7	A	293D475(1)6R3A(2)	0.5	6	5.50	0.12
4.7	B	293D475(1)6R3B(2)	0.5	6	4.40	0.14
6.8	A	293D685(1)6R3A(2)	0.5	6	5.00	0.12
6.8	B	293D685(1)6R3B(2)	0.5	6	3.40	0.16
10	A	293D106(1)6R3A(2)	0.6	6	3.40	0.15
10	B	293D106(1)6R3B(2)	0.6	6	2.90	0.17
10	C	293D106(1)6R3C(2)	0.6	6	3.00	0.19
15	A	293D156(1)6R3A(2)	0.9	6	2.90	0.16
15	B	293D156(1)6R3B(2)	0.9	6	2.50	0.18
15	C	293D156(1)6R3C(2)	0.9	6	1.80	0.25
22	A	293D226(1)6R3A(2)	1.3	6	2.90	0.16
22	B	293D226(1)6R3B(2)	1.3	6	2.00	0.21
22	C	293D226(1)6R3C(2)	1.3	6	1.80	0.25
33	A	293D336(1)6R3A(2)	2.0	14	2.50	0.17
33	B	293D336(1)6R3B(2)	2.0	6	1.90	0.21
33	C	293D336(1)6R3C(2)	2.0	6	1.50	0.27
47	A	293D476(1)6R3A(2)	2.8	12	1.60	0.22
47	B	293D476(1)6R3B(2)	2.8	6	1.90	0.21
47	C	293D476(1)6R3C(2)	2.8	6	1.40	0.28
47	D	293D476(1)6R3D(2)	2.8	6	0.80	0.43
68	B	293D686(1)6R3B(2)	4.1	6	1.80	0.22
68	C	293D686(1)6R3C(2)	4.1	6	0.80	0.37
68	D	293D686(1)6R3D(2)	4.1	6	0.70	0.46
100	B	293D107(1)6R3B(2)	6.0	15	1.70	0.22
100	C	293D107(1)6R3C(2)	6.0	6	0.80	0.37
100	D	293D107(1)6R3D(2)	6.0	6	0.70	0.46
100	E	293D107(1)6R3E(2)	6.0	8	0.70	0.49
120	D	293D127(1)6R3D(2)	6.3	8	0.70	0.46
150	C	293D157(1)6R3C(2)	9.0	8	0.70	0.40
150	D	293D157(1)6R3D(2)	9.0	8	0.60	0.50
150	E	293D157(1)6R3E(2)	9.0	8	0.50	0.57

Notes

- Part number definitions:
  - (1) Tolerance: X0, X9
  - (2) Terminations and packaging: 2TE3, 2WE3, 8T, 8W
  - (3) Lead (Pb)-free terminations and packaging codes: 2TE3, 2WE3
- (†) Rating in development, contact factory for availability.



STANDARD RATINGS						
CAPACITANCE ( $\mu$ F)	CASE CODE	PART NUMBER	MAX. DCL AT +25 °C ( $\mu$ A)	MAX. DF AT +25 °C 120 Hz (%)	MAX. ESR AT +25 °C 100 kHz ( $\Omega$ )	MAX. RIPPLE 100 kHz $I_{RMS}$ (A)
<b>6.3 V<sub>DC</sub> AT +85 °C; 4 V<sub>DC</sub> AT +125 °C</b>						
220	C	293D227(1)6R3C(2)	13.9	14	0.70	0.39
220	D	293D227(1)6R3D(2)	13.2	8	0.60	0.50
220	E	293D227(1)6R3E(2)	13.2	8	0.50	0.57
330	D	293D337(1)6R3D(2)	19.8	8	0.60	0.50
330	E	293D337(1)6R3E(2)	19.8	8	0.50	0.57
470	D	293D477(1)6R3D(2)	28.2	14	0.50	0.55
470	E	293D477(1)6R3E(2)	28.2	10	1.50	0.57
680	E	293D687(1)6R3E(2)	42.8	20	0.50	0.57
1000	E	293D108X06R3E(2)	63.0	30	0.40	0.64
<b>10 V<sub>DC</sub> AT +85 °C; 7 V<sub>DC</sub> AT +125 °C</b>						
0.47	A	293D474(1)010A(2)	0.5	4	14.00	0.07
1.0	A	293D105(1)010A(2)	0.5	4	9.60	0.09
1.5	A	293D155(1)010A(2)	0.5	6	8.00	0.10
2.2	A	293D225(1)010A(2)	0.5	6	6.30	0.11
2.2	B	293D225(1)010B(2)	0.5	6	4.60	0.14
3.3	A	293D335(1)010A(2)	0.5	6	5.50	0.12
3.3	B	293D335(1)010B(2)	0.5	6	5.50	0.12
4.7	A	293D475(1)010A(2)	0.5	6	5.00	0.12
4.7	B	293D475(1)010B(2)	0.5	6	3.40	0.16
4.7	C	293D475(1)010C(2)	0.5	6	2.30	0.22
6.8	A	293D685(1)010A(2)	0.7	6	4.20	0.13
6.8	B	293D685(1)010B(2)	0.7	6	2.90	0.17
6.8	C	293D685(1)010C(2)	0.7	6	1.90	0.24
10	A	293D106(1)010A(2)	1.0	6	3.40	0.15
10	B	293D106(1)010B(2)	1.0	6	2.50	0.18
10	C	293D106(1)010C(2)	1.0	6	1.80	0.25
15	A	293D156(1)010A(2)	1.5	6	2.90	0.16
15	B	293D156(1)010B(2)	1.5	6	2.00	0.21
15	C	293D156(1)010C(2)	1.5	6	1.80	0.25
22	A	293D226(1)010A(2)	2.2	8	2.50	0.17
22	B	293D226(1)010B(2)	2.2	6	1.90	0.21
22	C	293D226(1)010C(2)	2.2	6	1.50	0.27
22	D	293D226(1)010D(2)	2.2	6	1.50	0.32
33	B	293D336(1)010B(2)	3.3	6	1.90	0.21
33	C	293D336(1)010C(2)	3.3	6	1.40	0.28
33	D	293D336(1)010D(2)	3.3	6	0.80	0.43
47	B	293D476(1)010B(2)	4.7	6	1.80	0.22
47	C	293D476(1)010C(2)	4.7	6	1.10	0.32
47	D	293D476(1)010D(2)	4.7	6	0.70	0.46
68	B	293D686(1)010B(2)	6.8	14	1.80	0.22
68	C	293D686(1)010C(2)	6.8	6	1.00	0.33
68	D	293D686(1)010D(2)	6.8	6	0.70	0.46
68	E	293D686(1)010E(2)	6.8	6	0.80	0.45
68	V	293D686(1)010V(3)	6.8	6	0.70	0.42
100	B	293D107X0010B(2)	10.0	25	2.50	0.18
100	C	293D107(1)010C(2)	10.0	8	0.90	0.35
100	D	293D107(1)010D(2)	10.0	8	0.60	0.50
100	E	293D107(1)010E(2)	10.0	8	0.70	0.49
100	V	293D107(1)010V(3)	10.0	8	0.70	0.42

**Notes**

- Part number definitions:
  - Tolerance: X0, X9
  - Terminations and packaging: 2TE3, 2WE3, 8T, 8W
  - Lead (Pb)-free terminations and packaging codes: 2TE3, 2WE3
- Rating in development, contact factory for availability.



STANDARD RATINGS						
CAPACITANCE (μF)	CASE CODE	PART NUMBER	MAX. DCL AT +25 °C (μA)	MAX. DF AT +25 °C 120 Hz (%)	MAX. ESR AT +25 °C 100 kHz (Ω)	MAX. RIPPLE 100 kHz I <sub>RMS</sub> (A)
<b>10 V<sub>DC</sub> AT +85 °C; 7 V<sub>DC</sub> AT +125 °C</b>						
120	E	293D127(1)010E(2)	12.0	6	1.00	0.41
150	C	293D157X0010C(2)	15.0	20	0.90	0.35
150	D	293D157(1)010D(2)	15.0	8	0.60	0.50
150	E	293D157(1)010E(2)	15.0	8	0.50	0.57
220	D	293D227(1)010D(2)	22.0	8	0.60	0.50
220	E	293D227(1)010E(2)	22.0	8	0.50	0.57
220	V	293D227(1)010V(3)	30.0	12	0.50	0.50
330	D	293D337(1)010D(2)	33.0	15	0.50	0.57
330	E	293D337(1)010E(2)	33.0	10	0.50	0.57
470	E	293D477(1)010E(2)	47.0	15	0.50	0.57
<b>16 V<sub>DC</sub> AT +85 °C; 10 V<sub>DC</sub> AT +125 °C</b>						
0.68	A	293D684(1)016A(2)	0.5	4	10.40	0.08
1.0	A	293D105(1)016A(2)	0.5	4	9.30	0.09
1.5	A	293D155(1)016A(2)	0.5	6	6.70	0.11
1.5	B	293D155(1)016B(2)	0.5	6	6.40	0.12
2.2	A	293D225(1)016A(2)	0.5	6	5.90	0.11
2.2	B	293D225(1)016B(2)	0.5	6	4.60	0.14
3.3	A	293D335(1)016A(2)	0.5	6	5.00	0.12
3.3	B	293D335(1)016B(2)	0.5	6	3.50	0.16
4.7	A	293D475(1)016A(2)	0.8	6	5.00	0.12
4.7	B	293D475(1)016B(2)	0.8	6	2.90	0.17
4.7	C	293D475(1)016C(2)	0.8	6	2.90	0.19
6.8	A	293D685(1)016A(2)	1.1	6	4.20	0.13
6.8	B	293D685(1)016B(2)	1.1	6	2.50	0.18
6.8	C	293D685(1)016C(2)	1.1	6	1.90	0.24
10	A	293D106(1)016A(2)	1.6	6	3.00	0.16
10	B	293D106(1)016B(2)	1.6	6	2.00	0.21
10	C	293D106(1)016C(2)	1.6	6	1.80	0.25
10	D	293D106(1)016D(2)	2.5	6	1.20	0.35
15	B	293D156(1)016B(2)	2.4	6	2.00	0.21
15	C	293D156(1)016C(2)	2.4	6	1.50	0.27
22	B	293D226(1)016B(2)	3.5	6	1.90	0.21
22	C	293D226(1)016C(2)	3.5	6	1.40	0.28
22	D	293D226(1)016D(2)	3.5	6	0.80	0.43
33	B	293D336(1)016B(2)	5.3	6	1.80	0.22
33	C	293D336(1)016C(2)	5.3	6	1.10	0.32
33	D	293D336(1)016D(2)	5.3	6	0.70	0.46
47	C	293D476(1)016C(2)	7.5	6	1.00	0.33
47	D	293D476(1)016D(2)	7.5	6	0.70	0.46
47	E	293D476(1)016E(2)	7.5	6	0.80	0.45
68	D	293D686(1)016D(2)	10.9	6	0.60	0.50
68	E	293D686(1)016E(2)	10.9	6	0.80	0.45
100	D	293D107(1)016D(2)	16.0	8	0.60	0.50
100	E	293D107(1)016E(2)	16.0	8	0.60	0.52
100	V	293D107(1)016V(3)	16.0	10	0.40	0.56
150	D	293D157(1)016D(2)	24.0	8	0.60	0.50
150	E	293D157(1)016E(2)	24.0	8	0.50	0.57
220	E	293D227(1)016E(2)	35.2	14	0.50	0.57

Notes

- Part number definitions:
  - (1) Tolerance: X0, X9
  - (2) Terminations and packaging: 2TE3, 2WE3, 8T, 8W
  - (3) Lead (Pb)-free terminations and packaging codes: 2TE3, 2WE3
- (1) Rating in development, contact factory for availability.



STANDARD RATINGS						
CAPACITANCE ( $\mu$ F)	CASE CODE	PART NUMBER	MAX. DCL AT +25 °C ( $\mu$ A)	MAX. DF AT +25 °C 120 Hz (%)	MAX. ESR AT +25 °C 100 kHz ( $\Omega$ )	MAX. RIPPLE 100 kHz $I_{RMS}$ (A)
<b>20 V<sub>DC</sub> AT +85 °C; 13 V<sub>DC</sub> AT +125 °C</b>						
0.47	A	293D474(1)020A(2)	0.5	4	14.00	0.07
0.68	A	293D684(1)020A(2)	0.5	4	10.00	0.09
1.0	A	293D105(1)020A(2)	0.5	4	8.40	0.09
1.0	B	293D105(1)020B(2)	0.5	4	9.00	0.10
1.5	A	293D155(1)020A(2)	0.5	6	6.30	0.11
1.5	B	293D155(1)020B(2)	0.5	4.8	5.60	0.12
2.2	A	293D225(1)020A(2)	0.5	6	5.90	0.11
2.2	B	293D225(1)020B(2)	0.5	6	3.50	0.16
3.3	A	293D335(1)020A(2)	0.7	6	5.90	0.11
3.3	B	293D335(1)020B(2)	0.7	6	3.00	0.17
3.3	C	293D335(1)020C(2)	0.8	6	2.30	0.22
4.7	A	293D475(1)020A(2)	0.9	6	5.00	0.12
4.7	B	293D475(1)020B(2)	0.9	6	2.90	0.17
4.7	C	293D475(1)020C(2)	0.9	6	2.30	0.22
6.8	A	293D685(1)020A(2)	1.4	6	4.50	0.13
6.8	B	293D685(1)020B(2)	1.4	6	2.50	0.18
6.8	C	293D685(1)020C(2)	1.4	6	1.90	0.24
10	B	293D106(1)020B(2)	2.0	6	2.10	0.20
10	C	293D106(1)020C(2)	2.0	6	1.70	0.25
10	D	293D106(1)020D(2)	2.0	6	1.00	0.38
15	B	293D156(1)020B(2)	3.0	6	2.30	0.19
15	C	293D156(1)020C(2)	3.0	6	1.50	0.27
15	D	293D156(1)020D(2)	3.0	6	0.90	0.41
22	B	293D226(1)020B(2)	4.4	6	2.10	0.20
22	C	293D226(1)020C(2)	4.4	6	1.10	0.32
22	D	293D226(1)020D(2)	4.4	6	0.70	0.46
33	C	293D336(1)020C(2)	6.6	6	1.00	0.33
33	D	293D336(1)020D(2)	6.6	6	0.70	0.46
47	D	293D476(1)020D(2)	9.4	6	0.70	0.46
47	E	293D476(1)020E(2)	9.4	6	0.60	0.52
68	D	293D686(1)020D(2)	13.6	6	0.70	0.46
68	E	293D686(1)020E(2)	13.6	6	0.60	0.52
100	D	293D107(1)020D(2)	20.0	8	0.60	0.50
100	E	293D107(1)020E(2)	20.0	8	0.50	0.57
<b>25 V<sub>DC</sub> AT +85 °C; 17 V<sub>DC</sub> AT +125 °C</b>						
0.10	A	293D104(1)025A(2)	0.5	4	20.00	0.06
0.33	A	293D334(1)025A(2)	0.5	4	13.00	0.08
0.47	A	293D474(1)025A(2)	0.5	4	12.00	0.08
0.68	A	293D684(1)025A(2)	0.5	4	8.40	0.09
1.0	A	293D105(1)025A(2)	0.5	4	7.60	0.10
1.0	B	293D105(1)025B(2)	0.5	4	5.00	0.13
1.5	A	293D155(1)025A(2)	0.5	6	6.70	0.11
1.5	B	293D155(1)025B(2)	0.5	6	4.60	0.14
2.2	A	293D225(1)025A(2)	0.6	6	6.30	0.11
2.2	B	293D225(1)025B(2)	0.6	6	3.80	0.15
2.2	C	293D225(1)025C(2)	0.6	6	3.20	0.19
3.3	A	293D335(1)025A(2)	0.8	6	6.00	0.14
3.3	B	293D335(1)025B(2)	0.8	6	3.10	0.17
3.3	C	293D335(1)025C(2)	0.8	6	2.30	0.22

**Notes**

- Part number definitions:
  - Tolerance: X0, X9
  - Terminations and packaging: 2TE3, 2WE3, 8T, 8W
  - Lead (Pb)-free terminations and packaging codes: 2TE3, 2WE3
- Rating in development, contact factory for availability.



STANDARD RATINGS						
CAPACITANCE ( $\mu$ F)	CASE CODE	PART NUMBER	MAX. DCL AT +25 °C ( $\mu$ A)	MAX. DF AT +25 °C 120 Hz (%)	MAX. ESR AT +25 °C 100 kHz ( $\Omega$ )	MAX. RIPPLE 100 kHz $I_{RMS}$ (A)
<b>25 V<sub>DC</sub> AT +85 °C; 17 V<sub>DC</sub> AT +125 °C</b>						
4.7	A	293D475(1)025A(2)	1.2	6	5.50	0.12
4.7	B	293D475(1)025B(2)	1.2	6	2.80	0.17
4.7	C	293D475(1)025C(2)	1.2	6	2.00	0.24
4.7	D	293D475(1)025D(2)	1.2	6	1.30	0.34
6.8	B	293D685(1)025B(2)	1.7	6	2.40	0.19
6.8	C	293D685(1)025C(2)	1.7	6	1.70	0.25
6.8	D	293D685(1)025D(2)	1.7	6	1.10	0.37
10	B	293D106(1)025B(2)	2.5	6	2.30	0.19
10	C	293D106(1)025C(2)	2.5	6	1.50	0.27
10	D	293D106(1)025D(2)	2.5	6	1.00	0.39
15	B	293D156(1)025B(2)	3.8	6	2.20	0.20
15	C	293D156(1)025C(2)	3.8	6	1.20	0.30
15	D	293D156(1)025D(2)	3.8	6	0.80	0.43
22	C	293D226(1)025C(2)	5.5	6	1.20	0.30
22	D	293D226(1)025D(2)	5.5	6	0.70	0.46
22	E	293D226(1)025E(2)	5.5	6	0.80	0.45
22	V	293D226(1)025V(3)	5.5	6	0.70	0.42
33	D	293D336(1)025D(2)	8.3	6	0.70	0.46
33	E	293D336(1)025E(2)	8.3	6	0.60	0.52
47	D	293D476(1)025D(2)	11.8	8	0.70	0.46
47	E	293D476(1)025E(2)	11.8	6	0.60	0.52
68	E	293D686(1)025E(2)	17.0	8	0.60	0.52
<b>35 V<sub>DC</sub> AT +85 °C; 23 V<sub>DC</sub> AT +125 °C</b>						
0.10	A	293D104(1)035A(2)	0.5	4	20.00	0.06
0.15	A	293D154(1)035A(2)	0.5	4	18.00	0.07
0.22	A	293D224(1)035A(2)	0.5	4	15.00	0.07
0.33	A	293D334(1)035A(2)	0.5	4	13.00	0.08
0.47	A	293D474(1)035A(2)	0.5	4	10.00	0.09
0.47	B	293D474(1)035B(2)	0.5	4	8.00	0.10
0.68	A	293D684(1)035A(2)	0.5	4	7.60	0.10
0.68	B	293D684(1)035B(2)	0.5	4	6.50	0.11
1.0	A	293D105(1)035A(2)	0.5	4	7.50	0.10
1.0	B	293D105(1)035B(2)	0.5	4	5.00	0.13
1.5	B	293D155(1)035B(2)	0.5	6	4.20	0.14
1.5	C	293D155(1)035C(2)	0.5	6	3.80	0.17
2.2	B	293D225(1)035B(2)	0.8	6	3.80	0.15
2.2	C	293D225(1)035C(2)	0.8	6	2.90	0.20
3.3	B	293D335(1)035B(2)	1.2	6	3.50	0.16
3.3	C	293D335(1)035C(2)	1.2	6	2.10	0.23
3.3	D	293D335(1)035D(2)	1.2	6	1.70	0.30

**Notes**

- Part number definitions:
  - Tolerance: X0, X9
  - Terminations and packaging: 2TE3, 2WE3, 8T, 8W
  - Lead (Pb)-free terminations and packaging codes: 2TE3, 2WE3
- (1) Rating in development, contact factory for availability.





STANDARD RATINGS						
CAPACITANCE ( $\mu$ F)	CASE CODE	PART NUMBER	MAX. DCL AT +25 °C ( $\mu$ A)	MAX. DF AT +25 °C 120 Hz (%)	MAX. ESR AT +25 °C 100 kHz ( $\Omega$ )	MAX. RIPPLE 100 kHz $I_{RMS}$ (A)
<b>35 V<sub>DC</sub> AT +85 °C; 23 V<sub>DC</sub> AT +125 °C</b>						
4.7	B	293D475(1)035B(2)	1.7	6	3.10	0.17
4.7	C	293D475(1)035C(2)	1.6	6	1.90	0.24
4.7	D	293D475(1)035D(2)	1.6	6	1.30	0.34
6.8	C	293D685(1)035C(2)	2.4	6	1.80	0.25
6.8	D	293D685(1)035D(2)	2.4	6	1.10	0.37
10	C	293D106(1)035C(2)	3.5	6	1.60	0.26
10	D	293D106(1)035D(2)	3.5	6	0.80	0.43
15	D	293D156(1)035D(2)	5.3	6	0.70	0.46
15	E	293D156(1)035E(2)	5.3	6	0.70	0.49
22	D	293D226(1)035D(2)	7.7	6	0.60	0.50
22	E	293D226(1)035E(2)	7.7	6	0.60	0.57
<b>50 V<sub>DC</sub> AT +85 °C; 33 V<sub>DC</sub> AT +125 °C</b>						
0.10	A	293D104(1)050A(2)	0.5	4	19.00	0.06
0.15	A	293D154(1)050A(2)	0.5	4	17.00	0.07
0.15	B	293D154(1)050B(2)	0.5	4	14.00	0.08
0.22	A	293D224(1)050A(2)	0.5	4	15.00	0.07
0.22	B	293D224(1)050B(2)	0.5	4	12.00	0.08
0.33	A	293D334(1)050A(2)	0.5	4	14.00	0.07
0.33	B	293D334(1)050B(2)	0.5	4	10.00	0.09
0.47	A	293D474(1)050A(2)	0.5	4	12.00	0.08
0.47	B	293D474(1)050B(2)	0.5	4	8.40	0.10
0.47	C	293D474(1)050C(2)	0.5	4	6.70	0.13
0.68	B	293D684(1)050B(2)	0.5	4	7.60	0.11
0.68	C	293D684(1)050C(2)	0.5	4	5.90	0.14
1.0	B	293D105(1)050B(2)	0.5	4	6.70	0.11
1.0	C	293D105(1)050C(2)	0.5	4	4.60	0.16
1.5	B	293D155(1)050B(2)	0.8	6	6.00	0.12
1.5	C	293D155(1)050C(2)	0.8	6	3.40	0.18
1.5	D	293D155(1)050D(2)	0.8	6	2.90	0.23
2.2	B	293D225(1)050B(2)	1.1	6	3.50	0.16
2.2	C	293D225(1)050C(2)	1.1	6	2.90	0.20
2.2	D	293D225(1)050D(2)	1.1	6	2.10	0.27
3.3	C	293D335(1)050C(2)	1.7	6	2.50	0.21
3.3	D	293D335(1)050D(2)	1.7	6	1.70	0.30
4.7	C	293D475(1)050C(2)	2.4	6	1.50	0.27
4.7	D	293D475(1)050D(2)	2.4	6	1.20	0.37
4.7	E	293D475(1)050E(2)	2.4	6	1.10	0.34
6.8	D	293D685(1)050D(2)	3.4	6	0.90	0.41
6.8	E	293D685(1)050E(2)	3.4	6	0.90	0.43
10	D	293D106(1)050D(2)	5.0	6	0.80	0.43
10	E	293D106(1)050E(2)	5.0	6	0.80	0.45
15	E	293D156(1)050E(2)	7.5	6	0.80	0.45
<b>63 V<sub>DC</sub> AT +85 °C; 40 V<sub>DC</sub> AT +125 °C</b>						
4.7	D	293D475(1)063D(2)	3.0	6	1.10	0.37
10	E	293D106(1)063E(2)	6.3	6	1.00	0.41

**Notes**

- Part number definitions:
  - Tolerance: X0, X9
  - Terminations and packaging: 2TE3, 2WE3, 8T, 8W
  - Lead (Pb)-free terminations and packaging codes: 2TE3, 2WE3
- Rating in development, contact factory for availability.



STANDARD RATINGS						
CAPACITANCE ( $\mu$ F)	CASE CODE	PART NUMBER	MAX. DCL AT +25 °C ( $\mu$ A)	MAX. DF AT +25 °C 120 Hz (%)	MAX. ESR AT +25 °C 100 kHz ( $\Omega$ )	MAX. RIPPLE 100 kHz $I_{RMS}$ (A)
<b>75 V<sub>DC</sub> AT +85 °C; 50 V<sub>DC</sub> AT +125 °C</b>						
0.10	A <sup>(1)</sup>	293D104(1)075A(2)	0.5	4	30.00	0.05
0.15	B <sup>(1)</sup>	293D154(1)075B(2)	0.5	4	25.00	0.06
0.22	B <sup>(1)</sup>	293D224(1)075B(2)	0.5	4	20.00	0.07
0.33	B <sup>(1)</sup>	293D334(1)075B(2)	0.5	4	15.00	0.08
0.47	B <sup>(1)</sup>	293D474(1)075B(2)	0.5	4	12.00	0.08
0.68	C <sup>(1)</sup>	293D684(1)075C(2)	0.6	4	10.00	0.11
1.0	D <sup>(1)</sup>	293D105(1)075D(2)	0.8	6	6.00	0.16
1.5	D <sup>(1)</sup>	293D155(1)075D(2)	1.1	6	4.00	0.19
2.2	D <sup>(1)</sup>	293D225(1)075D(2)	1.7	6	3.00	0.22
3.3	D <sup>(1)</sup>	293D335(1)075D(2)	2.5	8	2.50	0.24
4.7	E	293D475(1)075E(2)	3.5	10	2.50	0.26

**Notes**

- Part number definitions:
  - (1) Tolerance: X0, X9
  - (2) Terminations and packaging: 2TE3, 2WE3, 8T, 8W
  - (3) Lead (Pb)-free terminations and packaging codes: 2TE3, 2WE3
- <sup>(1)</sup> Rating in development, contact factory for availability.

RECOMMENDED VOLTAGE DERATING GUIDELINES (for temperatures below +85 °C)	
STANDARD CONDITIONS. FOR EXAMPLE: OUTPUT FILTERS	
Capacitor Voltage Rating	Operating Voltage
4.0	2.5
6.3	3.6
10	6.0
16	10
20	12
25	15
35	24
50	28
63	36
75	42
SEVERE CONDITIONS. FOR EXAMPLE: INPUT FILTERS	
Capacitor Voltage Rating	Operating Voltage
4.0	2.5
6.3	3.3
10	5.0
16	8.0
20	10
25	12
35	15
50	24
63	31
75	37

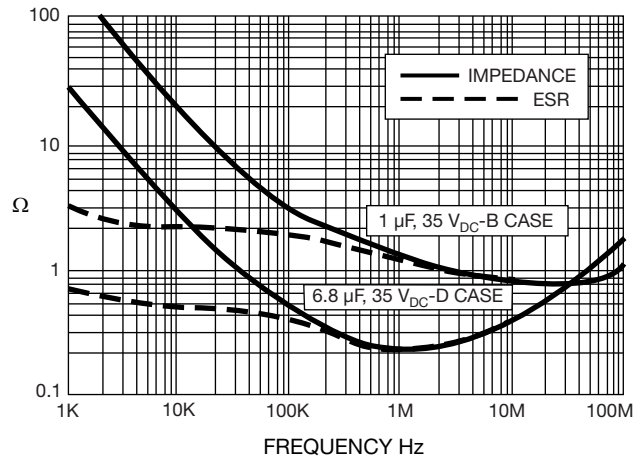
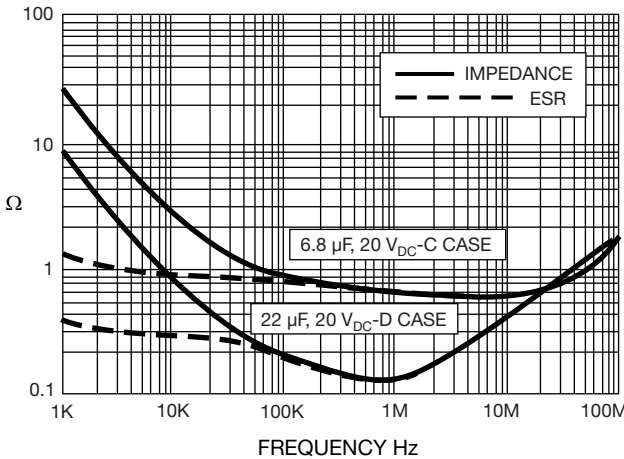
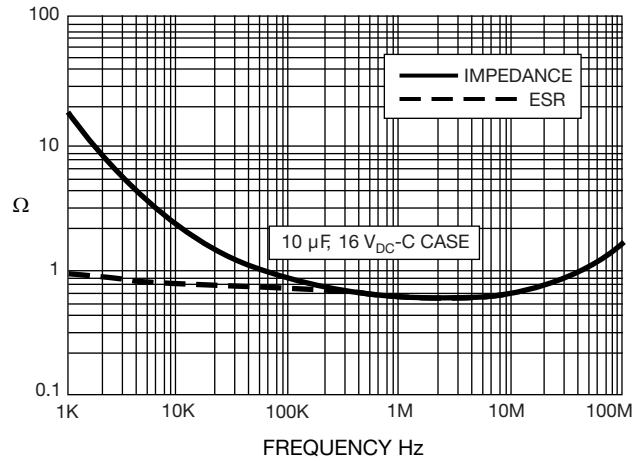
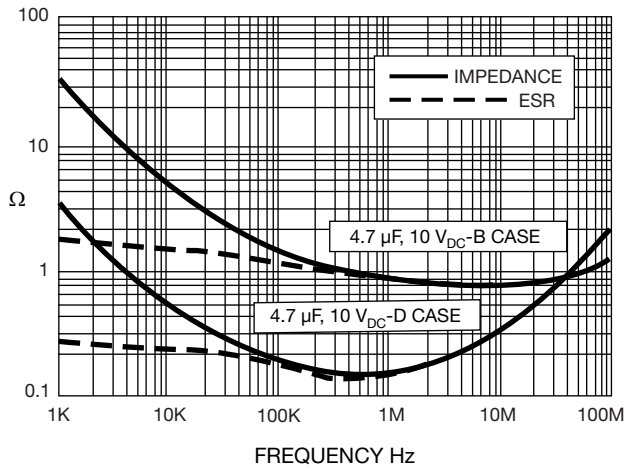
**TYPICAL CURVES AT +25 °C, IMPEDANCE AND ESR VS. FREQUENCY**

**POWER DISSIPATION**

CASE CODE	MAXIMUM PERMISSIBLE POWER DISSIPATION AT +25 °C (W) IN FREE AIR
A	0.075
B	0.085
C	0.110
D	0.150
E	0.165
V	0.125



STANDARD PACKAGING QUANTITY		
CASE CODE	UNITS PER REEL	
	7" REEL	13" REEL
A	2000	9000
B	2000	8000
C	500	3000
D	500	2500
E	400	1500
V	1000	5000

PRODUCT INFORMATION	
Guide for Molded Tantalum Capacitors	<a href="http://www.vishay.com/doc?40074">www.vishay.com/doc?40074</a>
Pad Dimensions	
Packaging Dimensions	
Moisture Sensitivity	<a href="http://www.vishay.com/doc?40135">www.vishay.com/doc?40135</a>
SELECTOR GUIDES	
Solid Tantalum Selector Guide	<a href="http://www.vishay.com/doc?49053">www.vishay.com/doc?49053</a>
Solid Tantalum Chip Capacitors	<a href="http://www.vishay.com/doc?40091">www.vishay.com/doc?40091</a>
FAQ	
Frequently Asked Questions	<a href="http://www.vishay.com/doc?40110">www.vishay.com/doc?40110</a>



# Guide for Molded Tantalum Capacitors

## INTRODUCTION

Tantalum electrolytic capacitors are the preferred choice in applications where volumetric efficiency, stable electrical parameters, high reliability, and long service life are primary considerations. The stability and resistance to elevated temperatures of the tantalum/tantalum oxide/manganese dioxide system make solid tantalum capacitors an appropriate choice for today's surface mount assembly technology.

Vishay Sprague has been a pioneer and leader in this field, producing a large variety of tantalum capacitor types for consumer, industrial, automotive, military, and aerospace electronic applications.

Tantalum is not found in its pure state. Rather, it is commonly found in a number of oxide minerals, often in combination with Columbium ore. This combination is known as "tantalite" when its contents are more than one-half tantalum. Important sources of tantalite include Australia, Brazil, Canada, China, and several African countries. Synthetic tantalite concentrates produced from tin slags in Thailand, Malaysia, and Brazil are also a significant raw material for tantalum production.

Electronic applications, and particularly capacitors, consume the largest share of world tantalum production. Other important applications for tantalum include cutting tools (tantalum carbide), high temperature super alloys, chemical processing equipment, medical implants, and military ordnance.

Vishay Sprague is a major user of tantalum materials in the form of powder and wire for capacitor elements and rod and sheet for high temperature vacuum processing.

## THE BASICS OF TANTALUM CAPACITORS

Most metals form crystalline oxides which are non-protecting, such as rust on iron or black oxide on copper. A few metals form dense, stable, tightly adhering, electrically insulating oxides. These are the so-called "valve" metals and include titanium, zirconium, niobium, tantalum, hafnium, and aluminum. Only a few of these permit the accurate control of oxide thickness by electrochemical means. Of these, the most valuable for the electronics industry are aluminum and tantalum.

Capacitors are basic to all kinds of electrical equipment, from radios and television sets to missile controls and automobile ignitions. Their function is to store an electrical charge for later use.

Capacitors consist of two conducting surfaces, usually metal plates, whose function is to conduct electricity. They are separated by an insulating material or dielectric. The dielectric used in all tantalum electrolytic capacitors is tantalum pentoxide.

Tantalum pentoxide compound possesses high-dielectric strength and a high-dielectric constant. As capacitors are being manufactured, a film of tantalum pentoxide is applied to their electrodes by means of an electrolytic process. The film is applied in various thicknesses and at various voltages and although transparent to begin with, it takes on different colors as light refracts through it. This coloring occurs on the tantalum electrodes of all types of tantalum capacitors.

Rating for rating, tantalum capacitors tend to have as much as three times better capacitance/volume efficiency than aluminum electrolytic capacitors. An approximation of the capacitance/volume efficiency of other types of capacitors may be inferred from the following table, which shows the dielectric constant ranges of the various materials used in each type. Note that tantalum pentoxide has a dielectric constant of 26, some three times greater than that of aluminum oxide. This, in addition to the fact that extremely thin films can be deposited during the electrolytic process mentioned earlier, makes the tantalum capacitor extremely efficient with respect to the number of microfarads available per unit volume. The capacitance of any capacitor is determined by the surface area of the two conducting plates, the distance between the plates, and the dielectric constant of the insulating material between the plates.

### COMPARISON OF CAPACITOR DIELECTRIC CONSTANTS

DIELECTRIC	$\epsilon$ DIELECTRIC CONSTANT
Air or Vacuum	1.0
Paper	2.0 to 6.0
Plastic	2.1 to 6.0
Mineral Oil	2.2 to 2.3
Silicone Oil	2.7 to 2.8
Quartz	3.8 to 4.4
Glass	4.8 to 8.0
Porcelain	5.1 to 5.9
Mica	5.4 to 8.7
Aluminum Oxide	8.4
<b>Tantalum Pentoxide</b>	<b>26</b>
Ceramic	12 to 400K

In the tantalum electrolytic capacitor, the distance between the plates is very small since it is only the thickness of the tantalum pentoxide film. As the dielectric constant of the tantalum pentoxide is high, the capacitance of a tantalum capacitor is high if the area of the plates is large:

$$C = \frac{\epsilon A}{t}$$

where

C = Capacitance

$\epsilon$  = Dielectric constant

A = Surface area of the dielectric

t = Thickness of the dielectric

Tantalum capacitors contain either liquid or solid electrolytes. In solid electrolyte capacitors, a dry material (manganese dioxide) forms the cathode plate. A tantalum lead is embedded in or welded to the pellet, which is in turn connected to a termination or lead wire. The drawings show the construction details of the surface mount types of tantalum capacitors shown in this catalog.



### SOLID ELECTROLYTE TANTALUM CAPACITORS

Solid electrolyte capacitors contain manganese dioxide, which is formed on the tantalum pentoxide dielectric layer by impregnating the pellet with a solution of manganous nitrate. The pellet is then heated in an oven, and the manganous nitrate is converted to manganese dioxide.

The pellet is next coated with graphite, followed by a layer of metallic silver, which provides a conductive surface between the pellet and the Leadframe.

Molded Chip tantalum capacitor encases the element in plastic resins, such as epoxy materials. After assembly, the capacitors are tested and inspected to assure long life and reliability. It offers excellent reliability and high stability for consumer and commercial electronics with the added feature of low cost

Surface mount designs of "Solid Tantalum" capacitors use lead frames or lead frameless designs as shown in the accompanying drawings.

### TANTALUM CAPACITORS FOR ALL DESIGN CONSIDERATIONS

Solid electrolyte designs are the least expensive for a given rating and are used in many applications where their very small size for a given unit of capacitance is of importance. They will typically withstand up to about 10 % of the rated DC working voltage in a reverse direction. Also important are their good low temperature performance characteristics and freedom from corrosive electrolytes.

Vishay Sprague patented the original solid electrolyte capacitors and was the first to market them in 1956. Vishay Sprague has the broadest line of tantalum capacitors and has continued its position of leadership in this field. Data sheets covering the various types and styles of Vishay Sprague capacitors for consumer and entertainment electronics, industry, and military applications are available where detailed performance characteristics must be specified.

#### MOLDED CHIP CAPACITOR, ALL TYPES EXCEPT 893D/TF3/T86

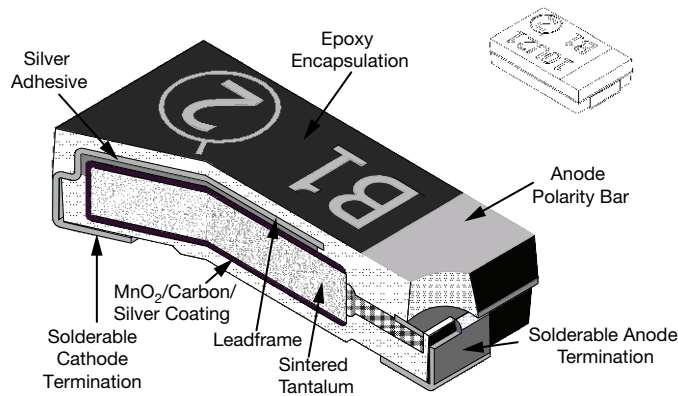

#### MOLDED CHIP CAPACITOR WITH BUILT-IN FUSE, TYPES 893D/TF3/T86

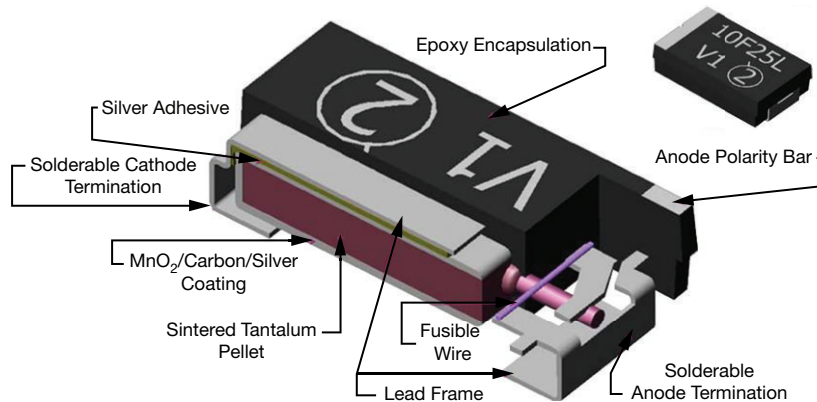

### COMMERCIAL PRODUCTS

SOLID TANTALUM CAPACITORS - MOLDED CASE						
SERIES	293D	793DE-793DX-CTC3-CTC4	593D	TR3	TP3	TL3
PRODUCT IMAGE						
TYPE	Surface mount TANTAMOUNT®, molded case					
FEATURES	Standard industrial grade	CECC approved	Low ESR	Low ESR	High performance, automotive grade	Very low DCL
TEMPERATURE RANGE	- 55 °C to + 125 °C					
CAPACITANCE RANGE	0.1 µF to 1000 µF	0.1 µF to 100 µF	1 µF to 470 µF	0.47 µF to 1000 µF	0.1 µF to 470 µF	0.1 µF to 470 µF
VOLTAGE RANGE	4 V to 75 V	4 V to 50 V	4 V to 50 V	4 V to 75 V	4 V to 50 V	4 V to 50 V
CAPACITANCE TOLERANCE	± 10 %, ± 20 %					
LEAKAGE CURRENT	0.01 CV or 0.5 µA, whichever is greater					0.005 CV or 0.25 µA, whichever is greater
DISSIPATION FACTOR	4 % to 30 %	4 % to 6 %	4 % to 15 %	4 % to 30 %	4 % to 15 %	4 % to 15 %
CASE CODES	A, B, C, D, E, V	A, B, C, D	A, B, C, D, E	A, B, C, D, E, V, W	A, B, C, D, E	A, B, C, D, E
TERMINATION	100 % matte tin standard, tin/lead available					

SOLID TANTALUM CAPACITORS - MOLDED CASE					
SERIES	TH3	TH4	TH5	893D	TF3
PRODUCT IMAGE					
TYPE	Surface mount TANTAMOUNT®, molded case				
FEATURES	High temperature + 150 °C, automotive grade	High temperature + 175 °C, automotive grade	Very high temperature + 200 °C	Built-in fuse	Built-in fuse, low ESR
TEMPERATURE RANGE	- 55 °C to + 150 °C	- 55 °C to + 175 °C	- 55 °C to + 200 °C	- 55 °C to + 125 °C	
CAPACITANCE RANGE	0.33 µF to 220 µF	10 µF to 47 µF	10 µF	0.47 µF to 680 µF	0.47 µF to 470 µF
VOLTAGE RANGE	6.3 V to 50 V	6.3 V to 16 V	21 V	4 V to 50 V	4 V to 50 V
CAPACITANCE TOLERANCE	± 10 %, ± 20 %				
LEAKAGE CURRENT	0.01 CV or 0.5 µA, whichever is greater				
DISSIPATION FACTOR	4 % to 8 %	4.5 % to 6 %	6 %	6 % to 15 %	6 % to 15 %
CASE CODES	A, B, C, D, E	B, C	E	C, D, E	C, D, E
TERMINATION	100 % matte tin standard, tin/lead and gold plated available	100 % matte tin	Gold plated	100 % matte tin standard, tin/lead available	



**HIGH RELIABILITY PRODUCTS**

<b>SOLID TANTALUM CAPACITORS - MOLDED CASE</b>					
SERIES	T83	T86	CWR11	04053	95158
PRODUCT IMAGE					
TYPE	TANTAMOUNT®, molded case, Hi-Rel. COTS		TANTAMOUNT®, molded case, DLA approved		
FEATURES	High reliability, standard and low ESR	High reliability, built-in fuse, standard and low ESR	MIL-PRF-55365/8 qualified	Built-in fuse	Low ESR
TEMPERATURE RANGE	- 55 °C to + 125 °C				
CAPACITANCE RANGE	0.1 µF to 470 µF	0.47 µF to 330 µF	0.1 µF to 100 µF	0.47 µF to 470 µF	4.7 µF to 220 µF
VOLTAGE RANGE	4 V to 63 V	4 V to 50 V			
CAPACITANCE TOLERANCE	± 10 %, ± 20 %		± 5 %, ± 10 %, ± 20 %	± 20 %	± 10 %, ± 20 %
LEAKAGE CURRENT	0.01 CV or 0.5 µA, whichever is greater				
DISSIPATION FACTOR	4 % to 15 %	6 % to 16 %	4 % to 6 %	4 % to 8 %	4 % to 12 %
CASE CODES	A, B, C, D, E	C, D, E	A, B, C, D	C, D, E	C, D, E
TERMINATION	100 % matte tin; tin/lead; tin/lead solder fused		Tin/lead; tin/lead solder fused	Tin/lead solder plated	Tin/lead solder plated; gold plated



### PLASTIC TAPE AND REEL PACKAGING in inches [millimeters]

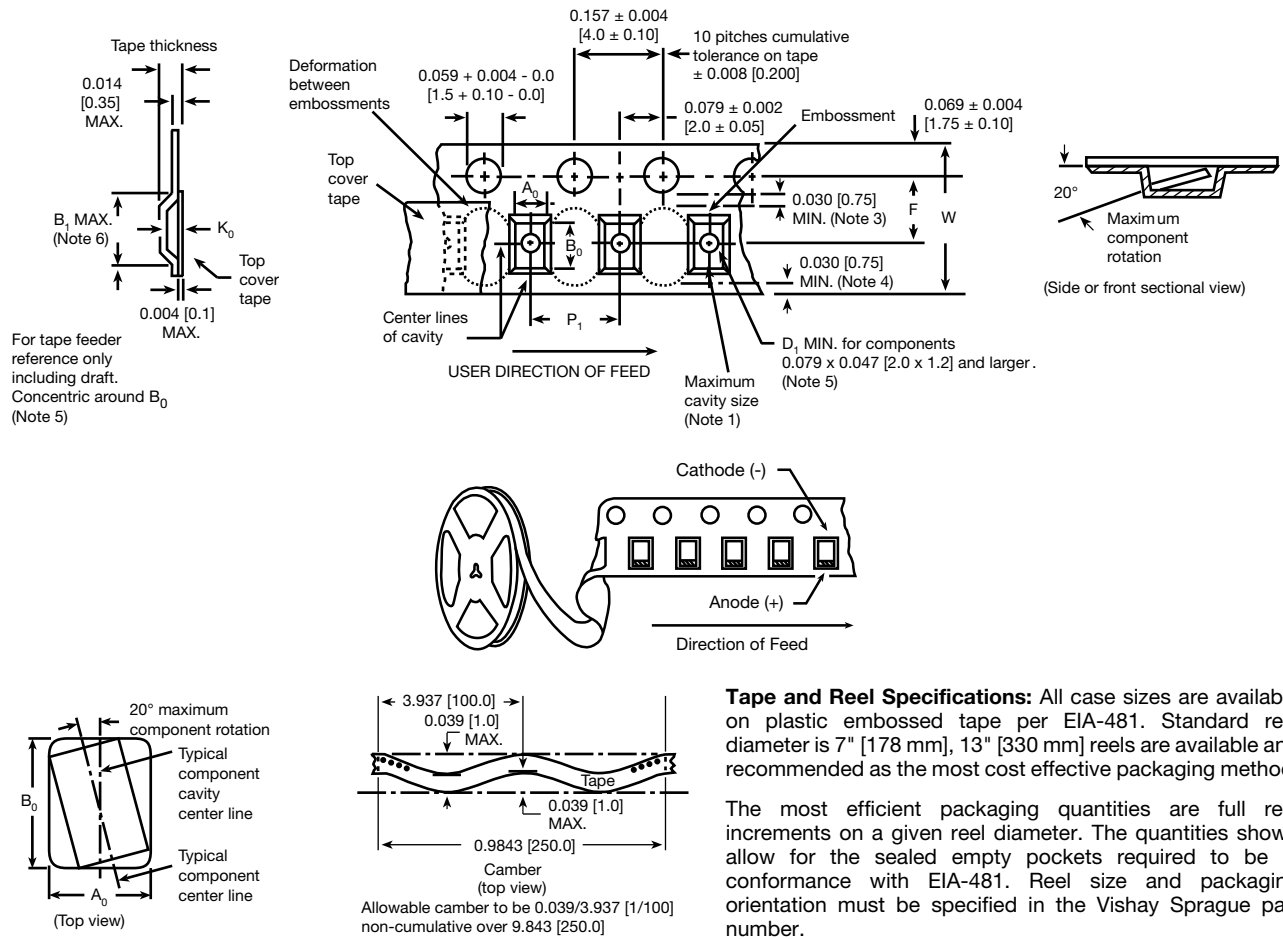

**Tape and Reel Specifications:** All case sizes are available on plastic embossed tape per EIA-481. Standard reel diameter is 7" [178 mm], 13" [330 mm] reels are available and recommended as the most cost effective packaging method.

The most efficient packaging quantities are full reel increments on a given reel diameter. The quantities shown allow for the sealed empty pockets required to be in conformance with EIA-481. Reel size and packaging orientation must be specified in the Vishay Sprague part number.

#### Notes

- Metric dimensions will govern. Dimensions in inches are rounded and for reference only.
- (1) A<sub>0</sub>, B<sub>0</sub>, K<sub>0</sub>, are determined by the maximum dimensions to the ends of the terminals extending from the component body and/or the body dimensions of the component. The clearance between the ends of the terminals or body of the component to the sides and depth of the cavity (A<sub>0</sub>, B<sub>0</sub>, K<sub>0</sub>) must be within 0.002" (0.05 mm) minimum and 0.020" (0.50 mm) maximum. The clearance allowed must also prevent rotation of the component within the cavity of not more than 20°.
- (2) Tape with components shall pass around radius "R" without damage. The minimum trailer length may require additional length to provide "R" minimum for 12 mm embossed tape for reels with hub diameters approaching N minimum.
- (3) This dimension is the flat area from the edge of the sprocket hole to either outward deformation of the carrier tape between the embossed cavities or to the edge of the cavity whichever is less.
- (4) This dimension is the flat area from the edge of the carrier tape opposite the sprocket holes to either the outward deformation of the carrier tape between the embossed cavity or to the edge of the cavity whichever is less.
- (5) The embossed hole location shall be measured from the sprocket hole controlling the location of the embossement. Dimensions of embossement location shall be applied independent of each other.
- (6) B<sub>1</sub> dimension is a reference dimension tape feeder clearance only.

CASE CODE	TAPE SIZE	B <sub>1</sub> (MAX.)	D <sub>1</sub> (MIN.)	F	K <sub>0</sub> (MAX.)	P <sub>1</sub>	W
<b>293D - 593D - 893D - TR3 - TH3 - TF3 - TP3 - 793DE/793DX/CTC3/CTC4</b>							
A	8 mm	0.165 [4.2]	0.039 [1.0]	0.138 ± 0.002 [3.5 ± 0.05]	0.094 [2.4]	0.157 ± 0.004 [4.0 ± 1.0]	0.315 ± 0.012 [8.0 ± 0.30]
B							
C							
D	12 mm	0.32 [8.2]	0.059 [1.5]	0.217 ± 0.00 [5.5 ± 0.05]	0.177 [4.5]	0.315 ± 0.004 [8.0 ± 1.0]	0.472 ± 0.012 [12.0 ± 0.30]
E							
V							
W							

### RECOMMENDED REFLOW PROFILES

Capacitors should withstand Reflow profile as per J-STD-020 standard

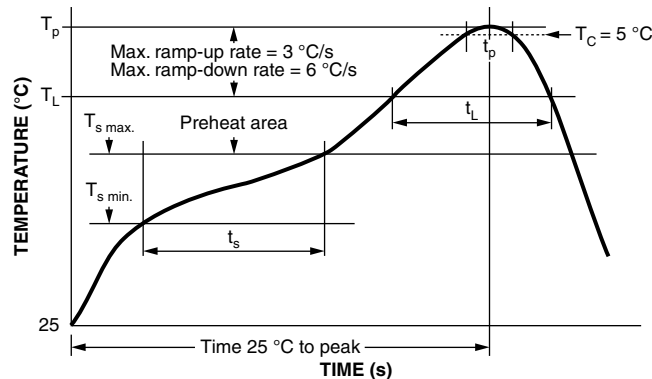

PROFILE FEATURE	SnPb EUTECTIC ASSEMBLY	LEAD (Pb)-FREE ASSEMBLY
<b>Preheat/soak</b>		
Temperature min. ( $T_{s \text{ min.}}$ )	100 °C	150 °C
Temperature max. ( $T_{s \text{ max.}}$ )	150 °C	200 °C
Time ( $t_s$ ) from ( $T_{s \text{ min.}}$ to $T_{s \text{ max.}}$ )	60 s to 120 s	60 s to 120 s
<b>Ramp-up</b>		
Ramp-up rate ( $T_L$ to $T_p$ )	3 °C/s max.	3 °C/s max.
Liquidous temperature ( $T_L$ )	183 °C	217 °C
Time ( $t_L$ ) maintained above $T_L$	60 s to 150 s	60 s to 150 s
Peak package body temperature ( $T_p$ )	Depends on case size - see table below	
Time ( $t_p$ ) within 5 °C of the specified classification temperature ( $T_C$ )	20 s	30 s
Time 25 °C to peak temperature	6 min max.	8 min max.
<b>Ramp-down</b>		
Ramp-down rate ( $T_p$ to $T_L$ )	6 °C/s max.	6 °C/s max.

### PEAK PACKAGE BODY TEMPERATURE ( $T_p$ )

CASE CODE	PEAK PACKAGE BODY TEMPERATURE ( $T_p$ )	
	SnPb EUTECTIC PROCESS	LEAD (Pb)-FREE PROCESS
A, B, C, V	235 °C	260 °C
D, E, W	220 °C	250 °C

### PAD DIMENSIONS in inches [millimeters]



CASE CODE	A (MIN.)	B (NOM.)	C (NOM.)	D (NOM.)
<b>293D - 593D - 893D - TR3 - TL3 - TH3 - TH4 - TH5 - TF3 - TP3 - 793DE/793DX/CTC3/CTC4 - T83 - T86 - CWR11 - 95158 - 04053</b>				
A	0.071 [1.80]	0.067 [1.70]	0.053 [1.35]	0.187 [4.75]
B	0.118 [3.00]	0.071 [1.80]	0.065 [1.65]	0.207 [5.25]
C	0.118 [3.00]	0.094 [2.40]	0.118 [3.00]	0.307 [7.80]
D	0.157 [4.00]	0.098 [2.50]	0.150 [3.80]	0.346 [8.80]
E	0.157 [4.00]	0.098 [2.50]	0.150 [3.80]	0.346 [8.80]
V	0.157 [4.00]	0.098 [2.50]	0.150 [3.80]	0.346 [8.80]
W	0.185 [4.70]	0.098 [2.50]	0.150 [3.80]	0.346 [8.80]



### GUIDE TO APPLICATION

- AC Ripple Current:** The maximum allowable ripple current shall be determined from the formula:

$$I_{RMS} = \sqrt{\frac{P}{R_{ESR}}}$$

where,

P = Power dissipation in W at + 25 °C as given in the tables in the product datasheets (Power Dissipation).

R<sub>ESR</sub> = The capacitor equivalent series resistance at the specified frequency

- AC Ripple Voltage:** The maximum allowable ripple voltage shall be determined from the formula:

$$V_{RMS} = I_{RMS} \times Z$$

or, from the formula:

$$V_{RMS} = Z \sqrt{\frac{P}{R_{ESR}}}$$

where,

P = Power dissipation in W at + 25 °C as given in the tables in the product datasheets (Power Dissipation).

R<sub>ESR</sub> = The capacitor equivalent series resistance at the specified frequency

Z = The capacitor impedance at the specified frequency

- The sum of the peak AC voltage plus the applied DC voltage shall not exceed the DC voltage rating of the capacitor.
- The sum of the negative peak AC voltage plus the applied DC voltage shall not allow a voltage reversal exceeding 10 % of the DC working voltage at + 25 °C.
- Reverse Voltage:** Solid tantalum capacitors are not intended for use with reverse voltage applied. However, they have been shown to be capable of withstanding momentary reverse voltage peaks of up to 10 % of the DC rating at 25 °C and 5 % of the DC rating at + 85 °C.
- Temperature Derating:** If these capacitors are to be operated at temperatures above + 25 °C, the permissible RMS ripple current or voltage shall be calculated using the derating factors as shown:

TEMPERATURE	DERATING FACTOR
+ 25 °C	1.0
+ 85 °C	0.9
+ 125 °C	0.4

- Power Dissipation:** Power dissipation will be affected by the heat sinking capability of the mounting surface. Non-sinusoidal ripple current may produce heating effects which differ from those shown. It is important that the equivalent I<sub>RMS</sub> value be established when calculating permissible operating levels. (Power dissipation calculated using + 25 °C temperature rise).

- Printed Circuit Board Materials:** Molded capacitors are compatible with commonly used printed circuit board materials (alumina substrates, FR4, FR5, G10, PTFE-fluorocarbon and porcelainized steel).

### 7. Attachment:

- Solder Paste:** The recommended thickness of the solder paste after application is 0.007" ± 0.001" [0.178 mm ± 0.025 mm]. Care should be exercised in selecting the solder paste. The metal purity should be as high as practical. The flux (in the paste) must be active enough to remove the oxides formed on the metallization prior to the exposure to soldering heat. In practice this can be aided by extending the solder preheat time at temperatures below the liquidous state of the solder.

- Soldering:** Capacitors can be attached by conventional soldering techniques; vapor phase, convection reflow, infrared reflow, wave soldering, and hot plate methods. The soldering profile charts show recommended time/temperature conditions for soldering. Preheating is recommended. The recommended maximum ramp rate is 2 °C per s. Attachment with a soldering iron is not recommended due to the difficulty of controlling temperature and time at temperature. The soldering iron must never come in contact with the capacitor.

- Backward and Forward Compatibility:** Capacitors with SnPb or 100 % tin termination finishes can be soldered using SnPb or lead (Pb)-free soldering processes.

- Cleaning (Flux Removal) After Soldering:** Molded capacitors are compatible with all commonly used solvents such as TES, TMS, Prelete, Chlorethane, Terpene and aqueous cleaning media. However, CFC/ODS products are not used in the production of these devices and are not recommended. Solvents containing methylene chloride or other epoxy solvents should be avoided since these will attack the epoxy encapsulation material.

- When using ultrasonic cleaning, the board may resonate if the output power is too high. This vibration can cause cracking or a decrease in the adherence of the termination. DO NOT EXCEED 9W/l at 40 kHz for 2 min.

- Recommended Mounting Pad Geometries:** Proper mounting pad geometries are essential for successful solder connections. These dimensions are highly process sensitive and should be designed to minimize component rework due to unacceptable solder joints. The dimensional configurations shown are the recommended pad geometries for both wave and reflow soldering techniques. These dimensions are intended to be a starting point for circuit board designers and may be fine tuned if necessary based upon the peculiarities of the soldering process and/or circuit board design.



## Typical Performance Characteristics Tantalum Capacitors

CAPACITOR ELECTRICAL PERFORMANCE CHARACTERISTICS				
ITEM	PERFORMANCE CHARACTERISTICS			
Category temperature range	-55 °C to +85 °C (to +125 °C with voltage derating)			
Capacitance tolerance	± 20 %, ± 10 % (at 120 Hz) 2 V <sub>RMS</sub> (max.) at +25 °C using a capacitance bridge			
Dissipation factor	Limit per Standard Ratings table. Tested via bridge method, at 25 °C, 120 Hz			
ESR	Limit per Standard Ratings table. Tested via bridge method, at 25 °C, 100 kHz			
Leakage current	After application of rated voltage applied to capacitors for 5 min using a steady source of power with 1 kΩ resistor in series with the capacitor under test, leakage current at 25 °C is not more than 0.01 CV or 0.5 μA, whichever is greater. <i>Note that the leakage current varies with temperature and applied voltage. See graph below for the appropriate adjustment factor.</i>			
Capacitance change by temperature	+12 % max. (at +125 °C) +10 % max. (at +85 °C) -10 % max. (at -55 °C)		For capacitance value > 300 μF +20 % max. (at +125 °C) +15 % max. (at +85 °C) -15 % max. (at -55 °C)	
Reverse voltage	Capacitors are capable of withstanding peak voltages in the reverse direction equal to: 10 % of the DC rating at +25 °C 5 % of the DC rating at +85 °C Vishay does not recommend intentional or repetitive application of reverse voltage			
Temperature derating	If capacitors are to be used at temperatures above +25 °C, the permissible RMS ripple current or voltage shall be calculated using the derating factors: 1.0 at +25 °C 0.9 at +85 °C 0.4 at +125 °C			
Operating temperature	<b>+85 °C</b>		<b>+125 °C</b>	
	<b>RATED VOLTAGE (V)</b>	<b>SURGE VOLTAGE (V)</b>	<b>RATED VOLTAGE (V)</b>	<b>SURGE VOLTAGE (V)</b>
	4	5.2	2.7	3.4
	6.3	8	4	5
	10	13	7	8
	16	20	10	12
	20	26	13	16
	25	32	17	20
	35	46	23	28
	50	65	33	40
	50 <sup>(1)</sup>	60	33	40
	63	76	42	50
75 <sup>(2)</sup>	75	50	50	

### Notes

- All information presented in this document reflects typical performance characteristics.
- <sup>(1)</sup> Capacitance values 15 μF and higher.
- <sup>(2)</sup> For 293D and TR3 only.

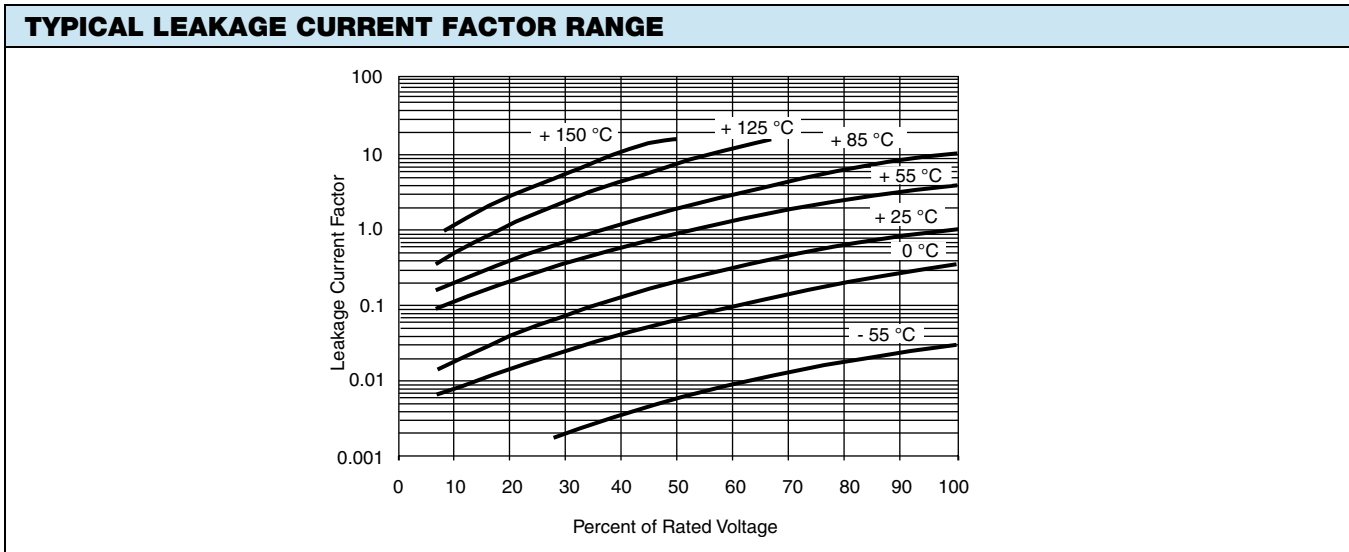

**Notes**

- At +25 °C, the leakage current shall not exceed the value listed in the Standard Ratings table.
- At +85 °C, the leakage current shall not exceed 10 times the value listed in the Standard Ratings table.
- At +125 °C, the leakage current shall not exceed 12 times the value listed in the Standard Ratings table.

CAPACITOR PERFORMANCE CHARACTERISTICS							
ITEM	PERFORMANCE CHARACTERISTICS						
Surge voltage	<p>Post application of surge voltage (as specified in the table above) in series with a 33 Ω resistor at the rate of 30 s ON, 30 s OFF, for 1000 successive test cycles at 85 °C, capacitors meet the characteristics requirements listed below.</p> <table border="0"> <tr> <td>Capacitance change</td> <td>Within ± 10 % of initial value</td> </tr> <tr> <td>Dissipation factor</td> <td>Initial specified value or less</td> </tr> <tr> <td>Leakage current</td> <td>Initial specified value or less</td> </tr> </table>	Capacitance change	Within ± 10 % of initial value	Dissipation factor	Initial specified value or less	Leakage current	Initial specified value or less
Capacitance change	Within ± 10 % of initial value						
Dissipation factor	Initial specified value or less						
Leakage current	Initial specified value or less						
Surge current	<p>After subjecting parts in series with a 1 Ω resistor at the rate of 3 s CHARGE, 3 s DISCHARGE, and a cap bank of 100K μF for 3 successive test cycles at 25 °C, capacitors meet the characteristics requirements listed below.</p> <table border="0"> <tr> <td>Capacitance change</td> <td>Within ± 10 % of initial value</td> </tr> <tr> <td>Dissipation factor</td> <td>Initial specified value or less</td> </tr> <tr> <td>Leakage current</td> <td>Initial specified value or less</td> </tr> </table>	Capacitance change	Within ± 10 % of initial value	Dissipation factor	Initial specified value or less	Leakage current	Initial specified value or less
Capacitance change	Within ± 10 % of initial value						
Dissipation factor	Initial specified value or less						
Leakage current	Initial specified value or less						
Life test at +85 °C	<p>Capacitors meet the characteristic requirements listed below. After 2000 h application of rated voltage at 85 °C.</p> <table border="0"> <tr> <td>Capacitance change</td> <td>Within ± 10 % of initial value</td> </tr> <tr> <td>Leakage current</td> <td>Shall not exceed 125 % of initial value</td> </tr> </table>	Capacitance change	Within ± 10 % of initial value	Leakage current	Shall not exceed 125 % of initial value		
Capacitance change	Within ± 10 % of initial value						
Leakage current	Shall not exceed 125 % of initial value						
Life test at +125 °C	<p>Capacitors meet the characteristic requirements listed below. After 1000 h application 2/3 of rated voltage at 125 °C.</p> <table border="0"> <tr> <td>Capacitance change for parts with cap. ≤ 600 μF</td> <td>Within ± 10 % of initial value</td> </tr> <tr> <td>for parts with cap. &gt; 600 μF</td> <td>Within ± 20 % of initial value</td> </tr> <tr> <td>Leakage current</td> <td>Shall not exceed 125 % of initial value</td> </tr> </table>	Capacitance change for parts with cap. ≤ 600 μF	Within ± 10 % of initial value	for parts with cap. > 600 μF	Within ± 20 % of initial value	Leakage current	Shall not exceed 125 % of initial value
Capacitance change for parts with cap. ≤ 600 μF	Within ± 10 % of initial value						
for parts with cap. > 600 μF	Within ± 20 % of initial value						
Leakage current	Shall not exceed 125 % of initial value						





## Disclaimer

ALL PRODUCT, PRODUCT SPECIFICATIONS AND DATA ARE SUBJECT TO CHANGE WITHOUT NOTICE TO IMPROVE RELIABILITY, FUNCTION OR DESIGN OR OTHERWISE.

Vishay Intertechnology, Inc., its affiliates, agents, and employees, and all persons acting on its or their behalf (collectively, "Vishay"), disclaim any and all liability for any errors, inaccuracies or incompleteness contained in any datasheet or in any other disclosure relating to any product.

Vishay makes no warranty, representation or guarantee regarding the suitability of the products for any particular purpose or the continuing production of any product. To the maximum extent permitted by applicable law, Vishay disclaims (i) any and all liability arising out of the application or use of any product, (ii) any and all liability, including without limitation special, consequential or incidental damages, and (iii) any and all implied warranties, including warranties of fitness for particular purpose, non-infringement and merchantability.

Statements regarding the suitability of products for certain types of applications are based on Vishay's knowledge of typical requirements that are often placed on Vishay products in generic applications. Such statements are not binding statements about the suitability of products for a particular application. It is the customer's responsibility to validate that a particular product with the properties described in the product specification is suitable for use in a particular application. Parameters provided in datasheets and/or specifications may vary in different applications and performance may vary over time. All operating parameters, including typical parameters, must be validated for each customer application by the customer's technical experts. Product specifications do not expand or otherwise modify Vishay's terms and conditions of purchase, including but not limited to the warranty expressed therein.

Except as expressly indicated in writing, Vishay products are not designed for use in medical, life-saving, or life-sustaining applications or for any other application in which the failure of the Vishay product could result in personal injury or death. Customers using or selling Vishay products not expressly indicated for use in such applications do so at their own risk. Please contact authorized Vishay personnel to obtain written terms and conditions regarding products designed for such applications.

No license, express or implied, by estoppel or otherwise, to any intellectual property rights is granted by this document or by any conduct of Vishay. Product names and markings noted herein may be trademarks of their respective owners.

## Material Category Policy

**Vishay Intertechnology, Inc. hereby certifies that all its products that are identified as RoHS-Compliant fulfill the definitions and restrictions defined under Directive 2011/65/EU of The European Parliament and of the Council of June 8, 2011 on the restriction of the use of certain hazardous substances in electrical and electronic equipment (EEE) - recast, unless otherwise specified as non-compliant.**

**Please note that some Vishay documentation may still make reference to RoHS Directive 2002/95/EC. We confirm that all the products identified as being compliant to Directive 2002/95/EC conform to Directive 2011/65/EU.**

**Vishay Intertechnology, Inc. hereby certifies that all its products that are identified as Halogen-Free follow Halogen-Free requirements as per JEDEC JS709A standards. Please note that some Vishay documentation may still make reference to the IEC 61249-2-21 definition. We confirm that all the products identified as being compliant to IEC 61249-2-21 conform to JEDEC JS709A standards.**